

Foreword

Welcome to the growing family of new NISSAN owners. This vehicle has been delivered to you with confidence. It has been produced using the latest techniques and strict quality control.

This manual was prepared to help you understand the operation and maintenance of your vehicle so that you may enjoy many kilometres (miles) of driving pleasure. Please read through this manual before operating your vehicle.

A separate Warranty Information & Maintenance Booklet explains in detail the warranty coverage that applies to your vehicle.

Your NISSAN dealer knows your vehicle best. When you require any service or have any questions, your NISSAN dealer will be glad to assist you with the extensive resources available for you.

IMPORTANT SAFETY INFORMATION

REMINDERS FOR SAFETY!

Follow these important driving rules to help ensure a safe and complete trip for you and your passengers!

- **NEVER** drive under the influence of alcohol or drugs.
- **ALWAYS** observe posted speed limits and never drive too fast for conditions.
- **ALWAYS** use your seat belts and appropriate child restraint systems. Preteen children should be seated in the rear seat.
- **ALWAYS** provide information about the proper use of vehicle safety features to all occupants of the vehicle.
- **ALWAYS** review this Owner's Manual for important safety information.

WHEN READING THE MANUAL

This manual includes information for all options available on this model. Therefore, you may find some information that does not apply to your vehicle.

All information, specifications and illustrations in this manual are those in effect at the time of printing. NISSAN reserves the right to change specifications or designs at any time without notice and without obligation.

MODIFICATION OF YOUR VEHICLE

This vehicle should not be modified. Modifications could affect its performance, safety or durability, and may even violate governmental regulations. In addition, damage or performance problems resulting from modifications may not be covered under NISSAN warranties.

READ FIRST — THEN DRIVE SAFELY

Before driving your vehicle, read this Owner's Manual carefully. This will ensure familiarity with controls and maintenance requirements, assisting you in the safe operation of your vehicle.

Throughout this manual the following symbols and words are used:



WARNING

Indicates the presence of a hazard that could cause death or serious personal injury. To avoid or reduce the risk, the procedures described must be followed precisely.

CAUTION

Indicates the presence of a hazard that could cause minor or moderate personal injury, or damage to your vehicle. To avoid or reduce the risk, the procedures described must be followed carefully.

NOTE

Indicates additional helpful information.





NISSAN
GREEN PROGRAM

The NISSAN GREEN PROGRAM symbol indicates environmentally friendly information and best practices.

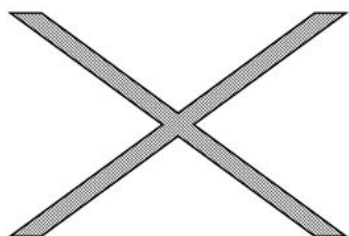

This symbol means "Do not do this" or "Do not let this happen".



Arrows in an illustration that are similar to these point to the front of the vehicle.



Arrows in an illustration that are similar to these indicate movement or action.



Arrows in an illustration that are similar to these call attention to an item in the illustration.

ON-PAVEMENT AND OFF-ROAD DRIVING (4WD models)

This vehicle will handle and manoeuvre differently from an ordinary passenger vehicle, because it has a higher centre of gravity for off-road use. As with other vehicles with features of this type, failure to operate this vehicle correctly may result in loss of control or an accident.

Be sure to read "On-pavement and off-road driving precautions" and "Four-wheel drive (4WD)" in the "5. Starting and driving" section of this manual.

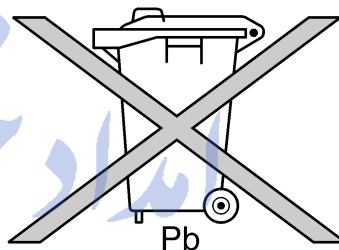

BATTERY DISPOSAL

CAUTION

An improperly disposed battery can harm the environment. Always confirm local regulations for battery disposal.

Examples of the batteries that the vehicle contains:

- Vehicle battery
- Remote controller battery (for Intelligent Key and/or Remote keyless entry system)
- Tyre Pressure Monitoring System (TPMS) sensor battery
- Remote controller battery (for Mobile Entertainment system)

If in doubt, contact your local authority, or a NISSAN dealer, or a qualified workshop for advice on disposal.





Bluetooth® is a trademark owned by Bluetooth SIG, Inc.



iPod® is a trademark of Apple Inc.

©2011 Nissan International SA, Switzerland

امداد خودرو فارما

تلفن شبانه روزی: ۰۲۱-۸۸۸۶۲۰۸۵

FarmaSOS.com



Contents

Illustrated table of contents	0
Safety – seats, seat belts and supplemental restraint system	1
Instruments and controls	2
Pre-driving checks and adjustments	3
Display screen, heater and air conditioner, and audio system	4
Starting and driving	5
In case of emergency *تلفن شبانه روزی: ۰۲۱-۸۸۶۲۰۸۵	6
Appearance and care	7
Maintenance and do-it-yourself	8
Technical information	9
Index	10



امداد خودرو فارما

تلفن شبانه روزی: ۰۸۵-۸۸۸۶۲۰۲۱

FarmaSOS.com



0 Illustrated table of contents

Air bag system.....	0-2	HR16DE engine (Type A)	0-8
Exterior front and rear	0-3	HR16DE engine (Type B)	0-8
Instrument and control layout	0-4	MR20DE engine	0-9
Left (LHD) and Right-hand drive (RHD)		Euro 4 K9K engine	0-11
models	0-5	Euro 5 K9K engine	0-11
Meters and gauges	0-6	M9R engine	0-12
Engine compartment.....	0-7	R9M engine.....	0-13

تلفن شبانه روزی: ۰۸۵ ۰۸۸۶۲ ۰۲۱

FarmaSOS.com

AIR BAG SYSTEM

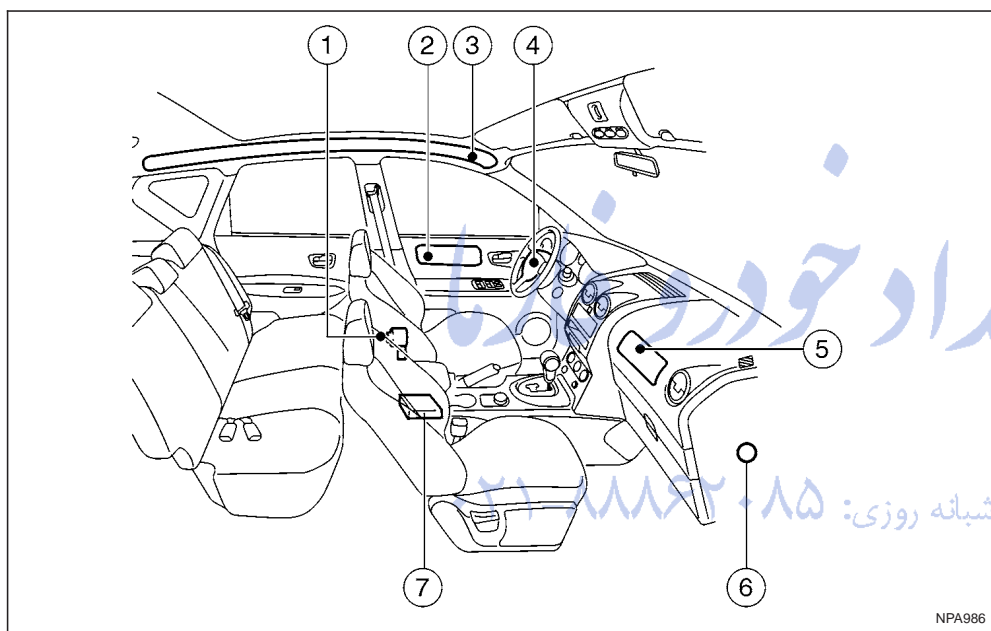

1. Pre-tensioner seat belt retractors (P. 1-12)
2. Side air bag modules (P. 1-14)
3. Curtain air bag modules (P. 1-14)
4. Driver air bag module (P. 1-14)
5. Front passenger air bag module (P. 1-16)
6. Front passenger air bag deactivate switch (P. 1-17)
7. Diagnosis sensor unit

0-2 Illustrated table of contents

EXTERIOR FRONT AND REAR

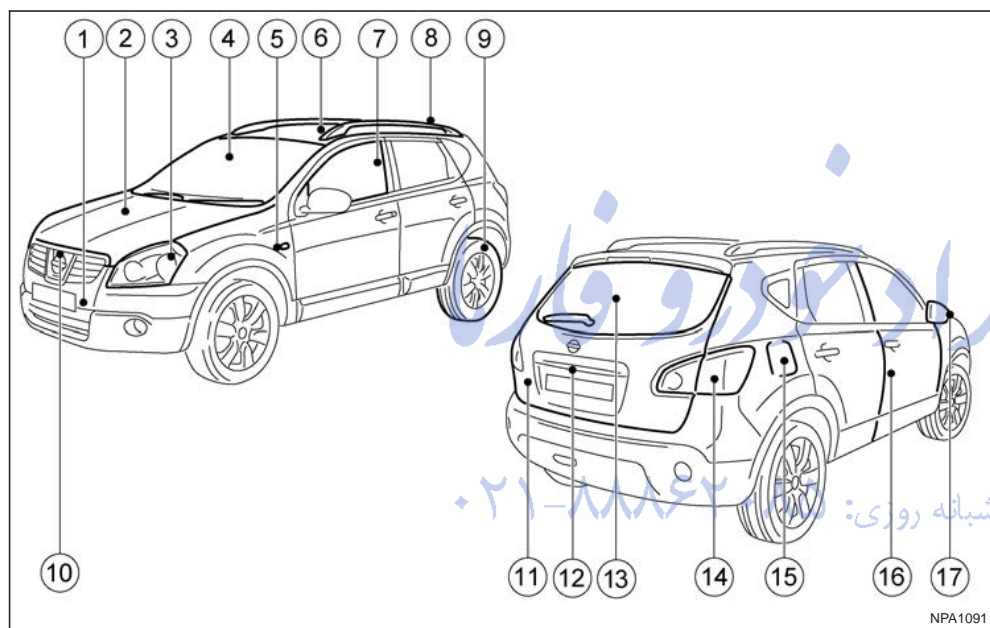

- ① Towing eye (P. 6-15)
- ② Bonnet (P. 3-14)
- ③ Headlights, front side lights, turn signal lights (Switch P. 2-24, Location and bulb replacement P. 8-25)
- ④ Windscreen (Wiper and washer switch

- ⑤ Side turn signal light (P. 2-24, Location and bulb replacement P. 8-27)
- ⑥ C-View® (Glass roof)* (P. 2-36)
- ⑦ Power windows (P. 2-34)
- ⑧ Roof rail* (P. 2-32)

- ⑨ Tyres (Tyres and wheels P. 8-31, P. 9-7, Flat tyre P. 6-2)
- ⑩ Front view camera* (Around view monitor, P. 4-4)
- ⑪ Back door (Door locks P. 3-12, Remote keyless entry system P. 3-3)
- ⑫ Rear view camera* (Rear-view monitor, P. 4-2, around view monitor, P. 4-4)
- ⑬ Rear window (Defogger switch P. 2-23, Wiper and washer switch P. 2-21, Wiper replacement P. 8-23, Washer fluid P. 8-16)
- ⑭ Rear combination light (Switch P. 2-24, Location and bulb replacement P. 8-25)
- ⑮ Fuel filler lid (P. 3-15)
- ⑯ Doors (Keys P. 3-2, Door locks P. 3-9, Remote keyless entry system P. 3-3)
- ⑰ Outside rear-view mirrors (P. 3-17)
Side view camera* (Around view monitor, P. 4-4)

* where fitted

INSTRUMENT AND CONTROL LAYOUT

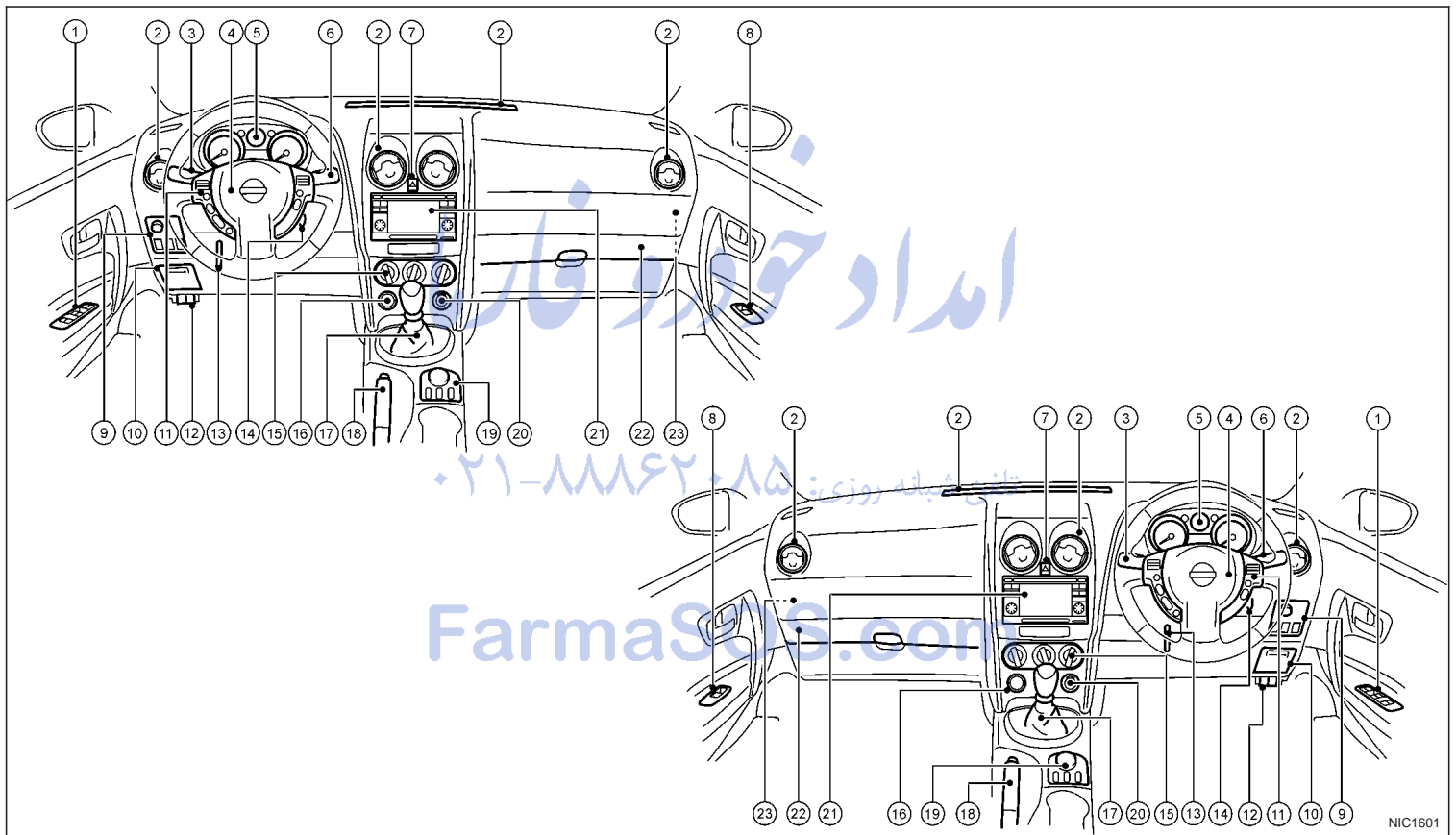

0-4 Illustrated table of contents



LEFT (LHD) AND RIGHT-HAND DRIVE (RHD) MODELS

1. Driver's main power window switch (P. 2-35)
2. Vents (P. 4-12)
3. Headlight and turn signal switch (P. 2-24)
4. Horn (P. 2-29)
5. Meters, gauges, and warning/indicator lights (P. 2-2, 2-3)
6. Wiper/washer switch (P. 2-21)
Headlight cleaner*¹ (P. 2-28)
7. Hazard warning flasher switch (P. 2-28)
8. Passenger power window switch (P. 2-36)
9. ESP OFF switch*¹ (P. 5-40)
Headlight aiming control*¹ (P. 2-27)
Outside mirror folding switch*¹ (P. 3-18)
Outside mirror remote control (P. 3-18)
Stop/Start System OFF switch* (P. 5-21)
10. Fuse box (P. 8-23)
11. Steering wheel switches*¹
Audio control*¹ (P. 4-43)
Cruise control*¹ (P. 5-29)
Speed limiter*¹ (P. 5-31)
Trip computer display control*¹ (P. 2-16)
12. Bonnet lock release lever (P. 3-14)
- Fuel filler lid opener lever (P. 3-15)
13. Steering wheel lock lever (P. 4-16)
14. Ignition switch or Ignition knob (Intelligent Key models) (P. 5-6, 5-8)
15. Climate controls (P. 4-12)
16. High level vent control*¹ (P. 4-12)
Storage*¹ (P. 4-31)
17. Gear selector lever (P. 5-12)
18. Handbrake (P. 3-16)
19. 4WD mode control*¹ (P. 5-24)
Power door lock switch (P. 3-10)
Seat heater switches*¹ (P. 2-29)
20. Power outlet (P. 2-30)
21. Audio system (P. 4-21, 4-23): تلفن شبانه روزی: ۰۲۱۳۳۳۳۳۳۳۳
NISSAN Connect*²
Rear-view monitor*¹ (P. 4-2)
Around view monitor*¹ (P. 4-4)
22. Glove box (P. 2-31)
23. Front passenger air bag deactivate switch (P. 1-17)

*¹ where fitted

*² Refer to the separately provided NISSAN Connect Owner's Manual.

See the page number indicated in parentheses for operating details.

METERS AND GAUGES

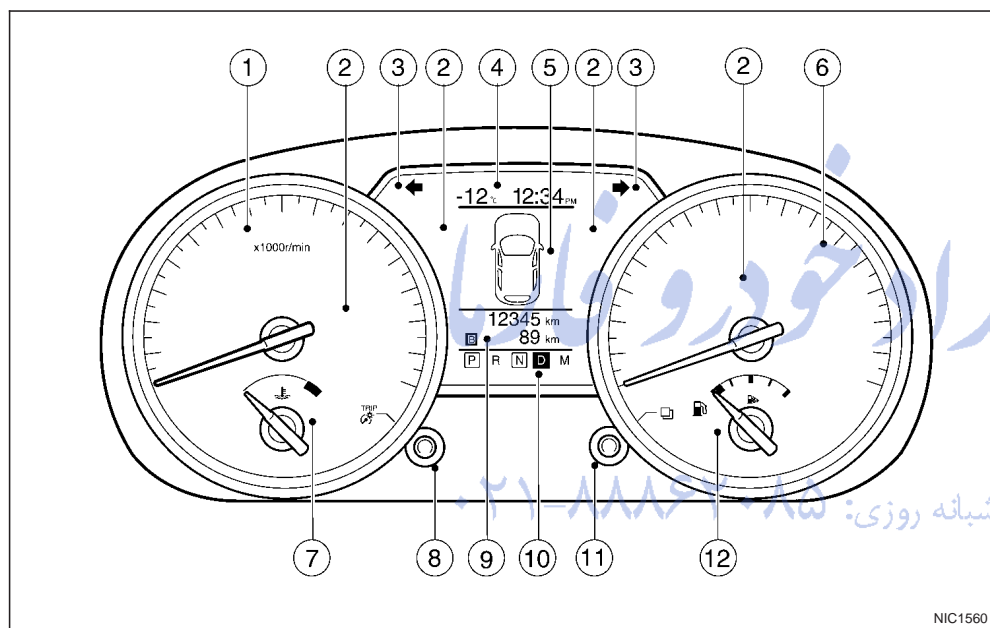

- ⑩ Gear indicator (CVT and AT models only) (P. 2-14)
- ⑪  switch (Settings control and trip computer control) (P. 2-11)
- ⑫ Fuel gauge (P. 2-2)

- ① Tachometer (P. 2-2)
- ② Warning/indicator lights (P. 2-3)
- ③ Turn signal (P. 2-26)
Hazard warning indicator lights (P. 2-28)
- ④ Outside temperature display/Clock display.
Clock setting, see (P. 2-19)
- ⑤ Vehicle information display (P. 2-11)
- ⑥ Speedometer (P. 2-2)
- ⑦ Engine coolant temperature gauge (P. 2-2)
- ⑧  switch (Twin trip odometer control and brightness level control) (P. 2-11)
- ⑨ Odometer/Twin trip odometer display (P. 2-16)

0-6 Illustrated table of contents

ENGINE COMPARTMENT

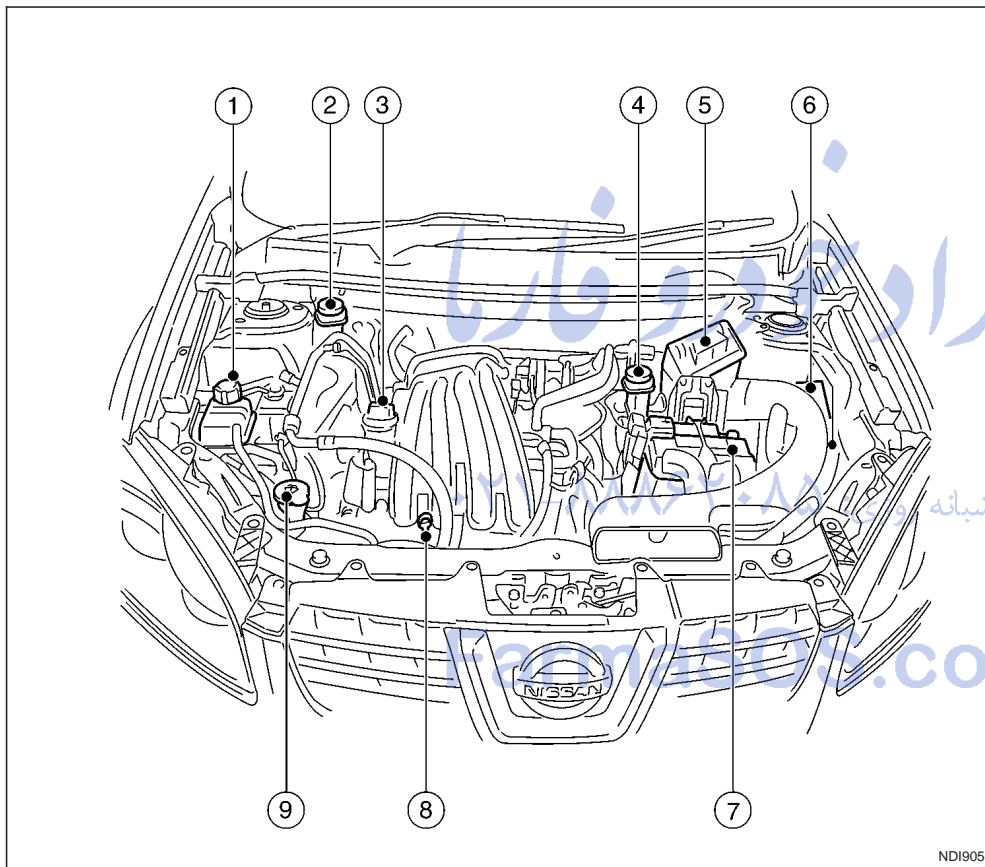

HR16DE ENGINE (Type A)

- ① Engine coolant reservoir (P. 8-6)
- ② Brake/clutch fluid reservoir (RHD models) (P. 8-15)
- ③ Engine oil filler cap (P. 8-8)
- ④ Brake/clutch fluid reservoir (LHD models) (P. 8-15)
- ⑤ Air cleaner filter (P. 8-21)
- ⑥ Fuses/fusible link box (P. 8-23)
- ⑦ Battery (P. 8-17)
- ⑧ Engine oil dipstick (P. 8-8)
- ⑨ Window washer/headlight cleaner (where fitted) fluid reservoir (P. 8-16)

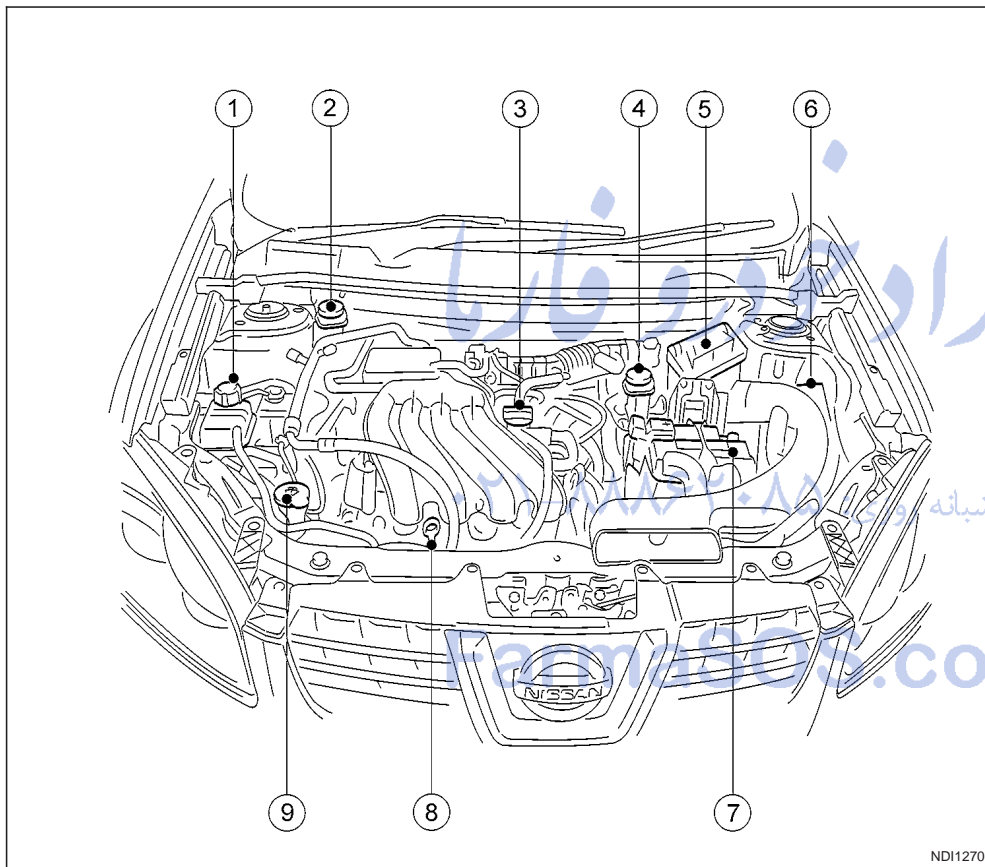

HR16DE ENGINE (Type B)

- ① Engine coolant reservoir (P. 8-6)
- ② Brake/clutch fluid reservoir (RHD models) (P. 8-15)
- ③ Engine oil filler cap (P. 8-8)
- ④ Brake/clutch fluid reservoir (LHD models) (P. 8-15)
- ⑤ Air cleaner filter (P. 8-21)
- ⑥ Fuses/fusible link box (P. 8-23)
- ⑦ Battery (P. 8-17)
- ⑧ Engine oil dipstick (P. 8-8)
- ⑨ Window washer/headlight cleaner (where fitted) fluid reservoir (P. 8-16)

NDI1270



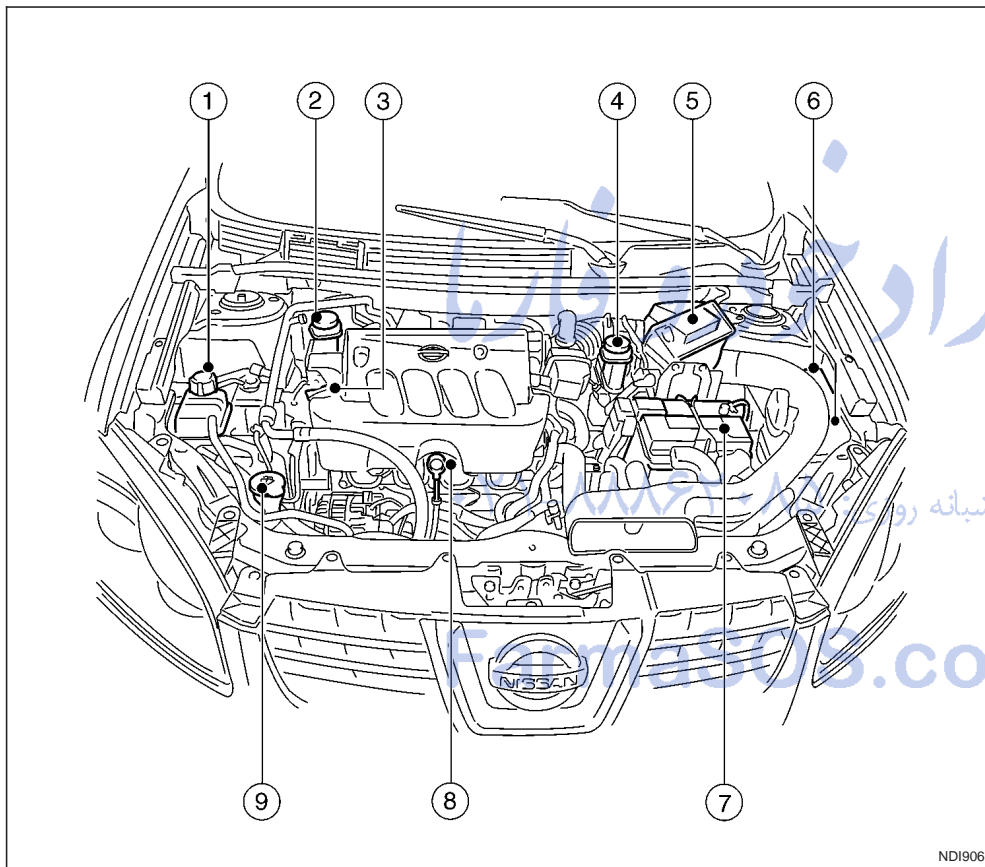

MR20DE ENGINE

- ① Engine coolant reservoir (P. 8-6)
- ② Brake/clutch fluid reservoir (MT (RHD) models), Brake fluid reservoir (CVT (RHD) models) (P. 8-15)
- ③ Engine oil filler cap (P. 8-8)
- ④ Brake/clutch fluid reservoir (MT (LHD) models), Brake fluid reservoir (CVT (LHD) models) (P. 8-15)
- ⑤ Air cleaner filter (P. 8-21)
- ⑥ Fuses/fusible link box (P. 8-23)
- ⑦ Battery (P. 8-17)
- ⑧ Engine oil dipstick (P. 8-8)
- ⑨ Window washer/headlight cleaner (where fitted) fluid reservoir (P. 8-16)

NDI906

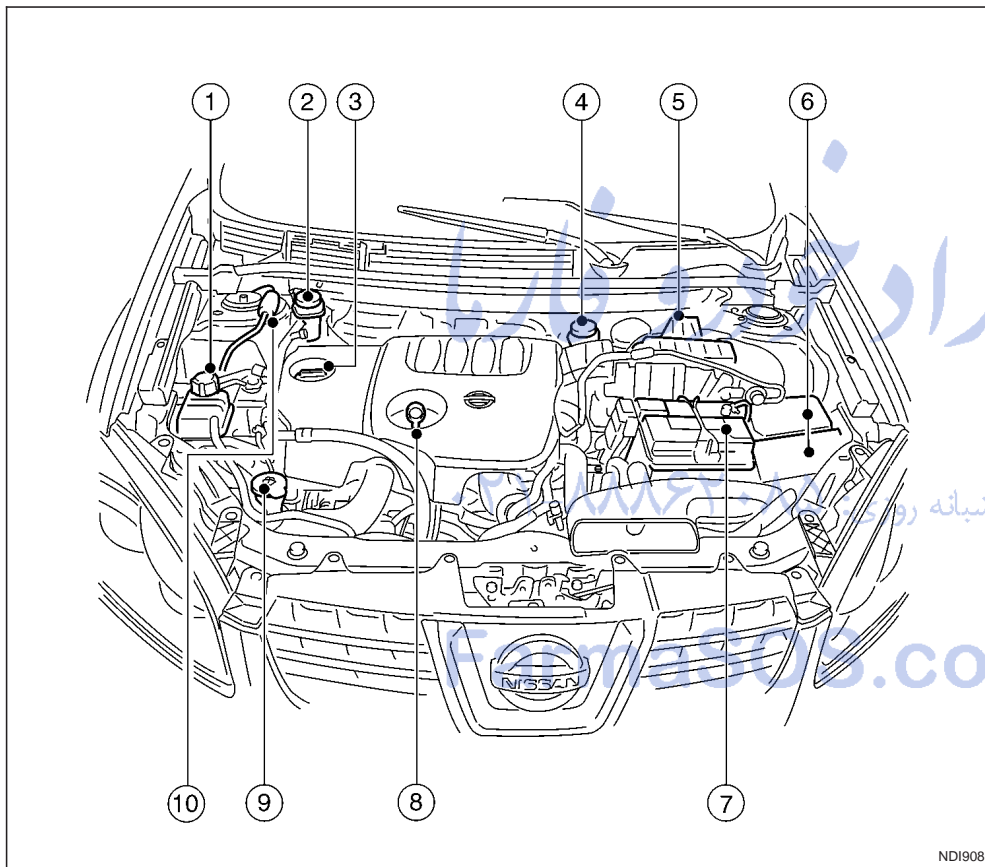

Euro 4 K9K engine

- ① Engine coolant reservoir (P. 8-6)
- ② Brake and clutch fluid reservoir (RHD models) (P. 8-15)
- ③ Engine oil filler cap (P. 8-8)
- ④ Brake/clutch fluid reservoir (LHD models) (P. 8-15)
- ⑤ Air cleaner filter (P. 8-21)
- ⑥ Fuses/fusible link box (P. 8-23)
- ⑦ Battery (P. 8-17)
- ⑧ Engine oil dipstick (P. 8-8)
- ⑨ Window washer/headlight cleaner (where fitted) fluid reservoir (P. 8-16)
- ⑩ Fuel filter priming bulb (P. 8-13)

NDI908



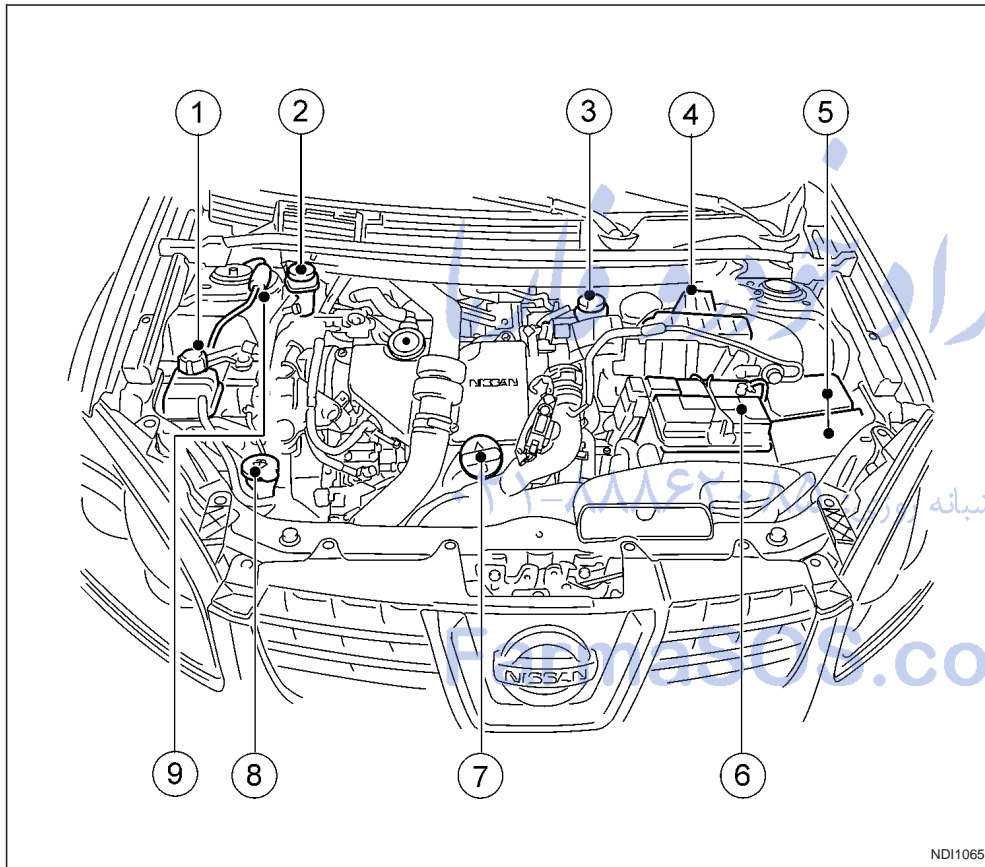

Euro 5 K9K engine

- ① Engine coolant reservoir (P. 8-6)
- ② Brake and clutch fluid reservoir (RHD models) (P. 8-15)
- ③ Brake/clutch fluid reservoir (LHD models) (P. 8-15)
- ④ Air cleaner filter (P. 8-21)
- ⑤ Fuses/fusible link box (P. 8-23)
- ⑥ Battery (P. 8-17)
- ⑦ Engine oil filler cap (P. 8-8)
Engine oil dipstick (P. 8-8)
- ⑧ Window washer/headlight cleaner (where fitted) fluid reservoir (P. 8-16)
- ⑨ Fuel filter priming bulb (P. 8-13)

NDI1065

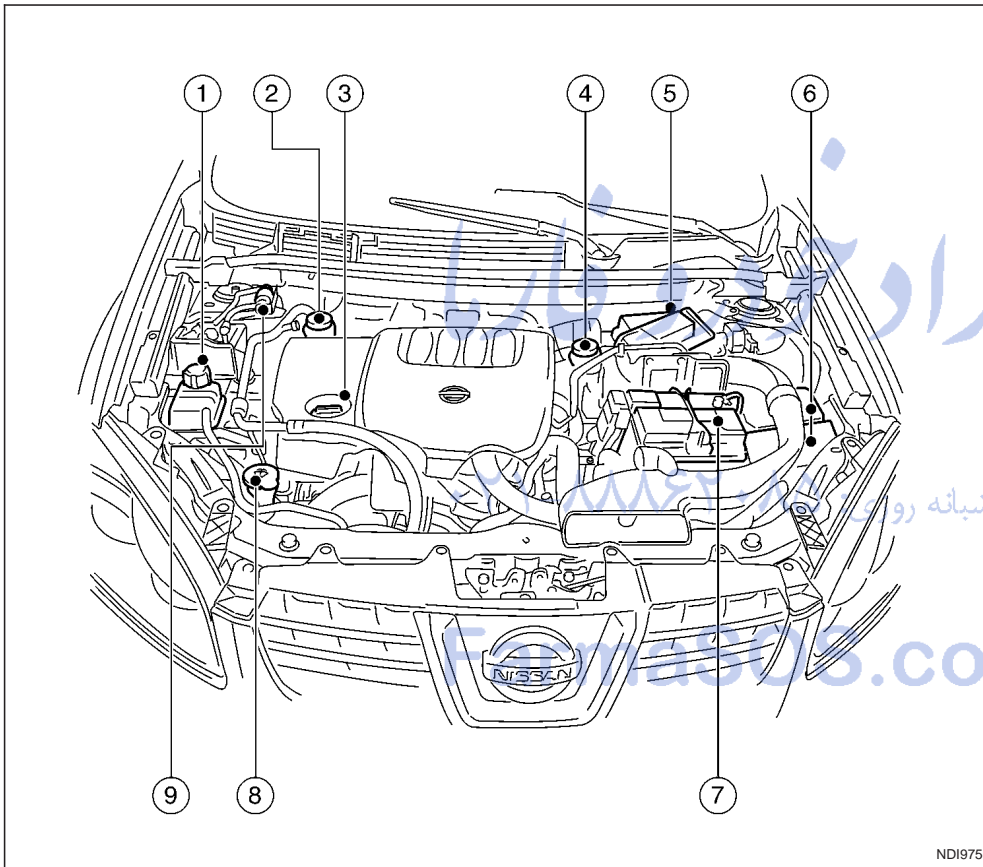

M9R ENGINE

- ① Engine coolant reservoir (P. 8-6)
- ② Brake/clutch fluid reservoir (MT (RHD) models), Brake fluid reservoir (AT (RHD) models) (P. 8-15)
- ③ Engine oil filler cap and dipstick (P. 8-8)
- ④ Brake/clutch fluid reservoir (MT (LHD) models), Brake fluid reservoir (AT (LHD) models) (P. 8-15)
- ⑤ Air cleaner filter (P. 8-21)
- ⑥ Fuses/fusible link box (P. 8-23)
- ⑦ Battery (P. 8-17)
- ⑧ Window washer/headlight cleaner (where fitted) fluid reservoir (P. 8-16)
- ⑨ Fuel filter priming bulb (P. 8-13)

NDI975



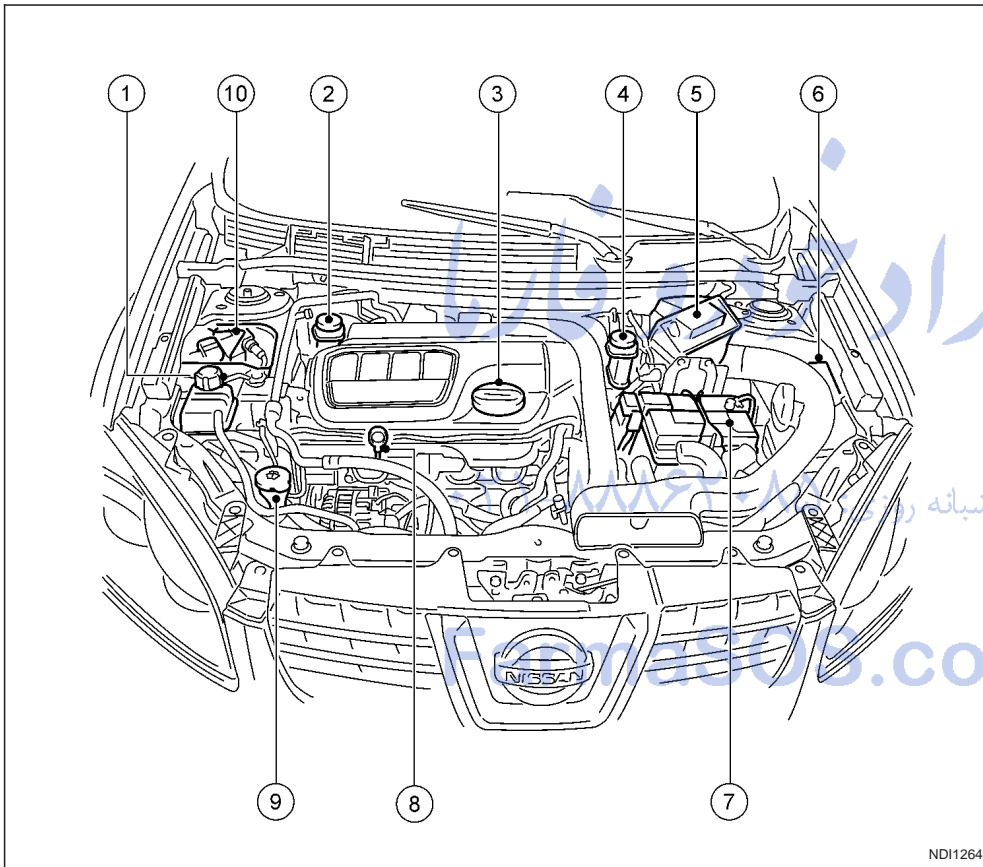

R9M ENGINE

- ① Engine coolant reservoir (P. 8-6)
- ② Brake/clutch fluid reservoir (MT (RHD) models), Brake fluid reservoir (AT (RHD) models) (P. 8-15)
- ③ Engine oil filler cap (P. 8-8)
- ④ Brake/clutch fluid reservoir (MT (LHD) models), Brake fluid reservoir (AT (LHD) models) (P. 8-15)
- ⑤ Air cleaner filter (P. 8-21)
- ⑥ Fuses/fusible link box (P. 8-23)
- ⑦ Battery (P. 8-17)
- ⑧ Oil dipstick (P. 8-8)
- ⑨ Window washer/headlight cleaner (where fitted) fluid reservoir (P. 8-16)
- ⑩ Fuel filter assembly (P. 8-13)

NDI1264

NOTE

امداد خودرو فارما

تلفن شبانه روزی: ۰۸۵-۸۸۸۶۲۰۲۱

FarmaSOS.com

0-14 Illustrated table of contents



1 Safety — seats, seat belts and supplemental restraint system

Seats.....	1-2	Pre-tensioner seat belt system	1-12
Front seats	1-2	Supplemental Restraint System (air bag system)	1-13
Rear seat(s).....	1-3	Air bag system.....	1-14
Armrests (where fitted)	1-5	Air bag warning labels	1-16
Head restraints	1-5	Air bag warning light.....	1-16
Active head restraints (front seats).....	1-6	Front passenger air bag indicator light	1-17
Seat belts	1-6	Child restraints	1-18
Seat belt warnings.....	1-6	Precautions on child restraint usage.....	1-18
Precautions on seat belt usage	1-7	Installation of a child restraint system on the	
Child safety	1-8	front passenger seat	1-23
Pregnant women	1-8	Installation of a child restraint system on rear	
Injured persons.....	1-9	seats	1-24
Three-point type seat belts.....	1-9	ISOFIX system (where fitted)	1-26
Seat belt maintenance	1-11	Top tether strap for child restraint	1-27

FarmaSOS.com

SEATS

WARNING

- Do not adjust the driver's seat while driving. The seat may move suddenly and could cause loss of control of the vehicle.
- After adjustment, gently rock in the seat to make sure it is securely locked.
- The seatback should not be reclined any more than needed for comfort. Seat belts are most effective when the passenger sits well back and upright in the seat. If the seatback is reclined, the risk of sliding under the lap belt and being injured is increased.
- When returning the seatbacks to the upright position, be certain that they are completely secured in the latched position. If they are not completely secured, passengers may be injured in an accident or sudden stop. When operating the seatback release always rock the seatback afterward to check that it is locked.
- When the vehicle is being used to carry cargo, properly secure all cargo to help prevent it from sliding or shifting. Do not place cargo higher than the seatbacks. In a sudden stop or collision, unsecured cargo could cause personal injury.
- Never allow anyone to ride in the luggage area or on the rear seat when it is in the folded-down position. Use of these areas by passengers without proper restraints could result in serious injury in an accident or sudden stop.

- Closely supervise children when they are around the vehicle to prevent them from playing and being locked in the luggage compartment where they could be seriously injured. Keep the vehicle locked with the rear seatback securely latched when not in use, and prevent children from having access to the vehicle's keys.

FRONT SEATS

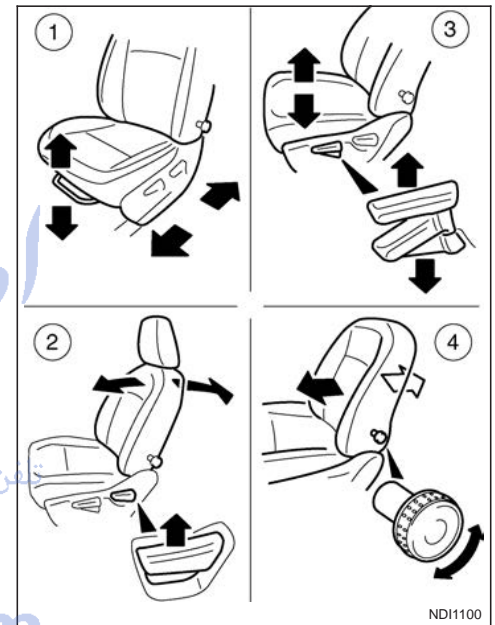

Adjustment

- ① Slide the seat forward and backward
- ② Reclining the seatback
- ③ Lift or lower the seat (driver's side only)
- ④ Lumbar support (where fitted)

1-2 Safety — seats, seat belts and supplemental restraint system



REAR SEAT(S)

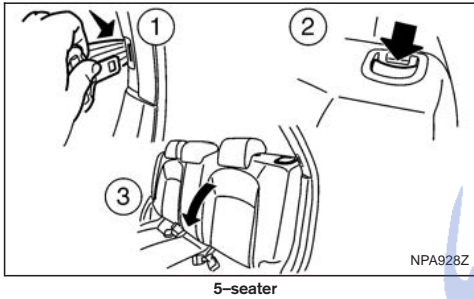

Folding (5-seater)

The luggage compartment loading capacity can be increased by folding the rear seats forward.

To fold the seat:

1. Insert the side seat belt tongue into the slot located on the rear door pillar ① as illustrated.
2. Release the seatback lock by pulling on the latch ②.
3. Fold the seat forward ③.

To return the seat to an upright position:

1. Make sure the seat belt is clear of the seat latch mechanism.
2. Lift the seatback up and push firmly onto the latch.
3. If the red lock tab is visible then the seat has not latched properly — release and then re-latch the seat.

CAUTION

Always ensure that the seat belt is not trapped in the release lever or any other vehicle part.

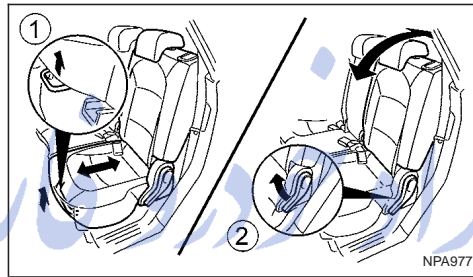

Adjustment 2nd row (7-seater)

Pull the lever ① up while you slide the seat forward or backward to the desired position. Release the lever to lock the seat in position. Rock the seat to check the slides have locked. Pull the lever ② to set the angle of the seatback as desired.

Folding 2nd row (7-seater)

To fold the outer seats:

1. Push the release button of the head restraint and push the head restraint down. See “Head restraints” later in this section.
2. Release the seatback lock by pulling the lever ② up. The lever must be held up until the seatback

is folded past the vertical position. If the lever is released early the seat will go into Easy entry mode, see “Easy entry to the 3rd row (7-seater)” later in this section.

3. Fold the seat forward.

To return the 2nd row outer seat to the seating position, pull and hold the lever ② up to push the seatback up until it locks into position. Pull the lever again to set the angle of the seatback as desired. Pull the head restraint into the correct position for the occupant using the seat.

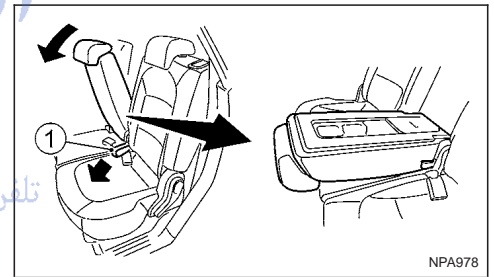

To fold the centre seat:

1. Push the release button of the head restraint and push the head restraint down. See “Head restraints” later in this section.
2. Make sure the seat belt tongue of the centre seat is in the store position, see “Fastening the seat belts” later in this section.
3. Release the seatback lock by pulling the strap ①.

4. Fold the seatback forward.

To return the 2nd row centre seat to its seating position, pull the strap to push the seatback up until it latches into position. Pull the strap again to set the angle of the seatback as desired. Pull the head restraint into the correct position for the occupant using the seat.

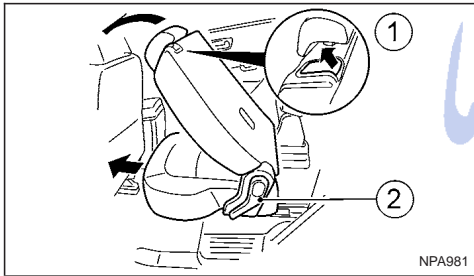

Easy entry to the 3rd row (7-seater)

1. The seating positions on the 2nd row can be slid forward for easy entry or exit from the 3rd row seat. To slide the 2nd row bench seat, lift up the latch (1) located on the upper corner of the seatback and pull the seatback forward. When pulling the seatback, the seat bench then slides forward.
2. To return the seat to its seating position, push the seat bench rearward then lift the seatback.

The seat will lock into position. Rock the seat to confirm it is locked in position. Adjust the seat if necessary, see "Adjustment 2nd row (7-seater)" earlier in this section.

NOTE

- Instead of using the latch, it is also possible to pull the lever (2) up. Pull the seatback past the vertical position and release the lever. The seat will slide forward.
- The 2nd row centre seat slides forward together with the right outer seat.

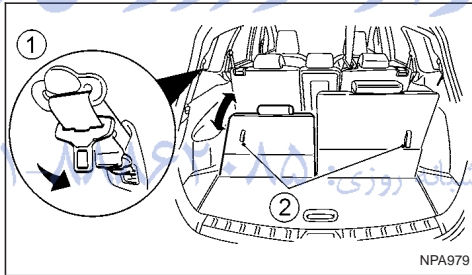

Folding 3rd row (7-seater)

1. Push the release button of the head restraint and push the head restraint down. See "Head restraints" later in this section.
2. Attach the side seat belt tongue to the stowage hook located on the rear pillar (1) as illustrated.
3. Release the seatback lock by pulling the strap (2).

4. Fold the seatback forward.

To return the 3rd row seat to its seating position, pull the strap to pull the seatback up until it locks into position. Pull the strap again to set the angle of the seatback as desired. Pull the head restraint into the highest position.

1-4 Safety — seats, seat belts and supplemental restraint system



ARMRESTS (where fitted)

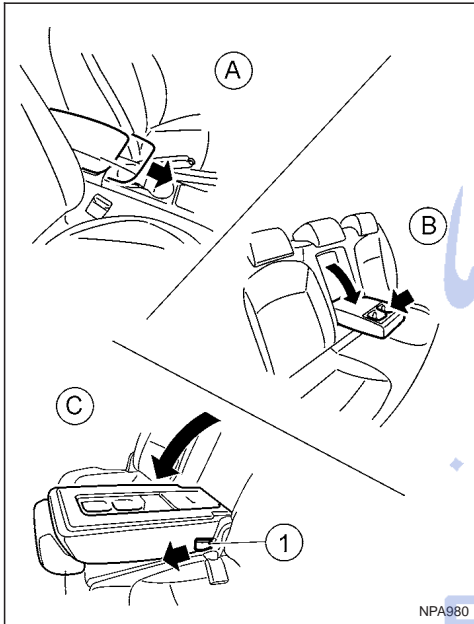

1. Front armrest (A)

Slide the console box lid forwards to use as an armrest.

2. Rear armrest (5-seater) (B)

Pull the armrest of the rear seat and lay it horizontally.

3. Rear armrest (7-seater) (C)

Pull the strap (1) at the centre seat bench and lay the centre seatback/armrest horizontally.

HEAD RESTRAINTS

⚠ WARNING

- Do not drive and/or ride in the vehicle with the head restraint removed. This can be dangerous.
- Head restraints should be adjusted properly as they may provide significant protection against injury in an accident. Check the height after someone else uses the seat.
- If the head restraints are removed for any reason, they should be securely stored to prevent them from causing injury to passengers or damage to the vehicle in case of sudden braking or an accident.
- 7-seater: The head restraints of the 3rd row should always be put into the highest position when the seat is occupied.

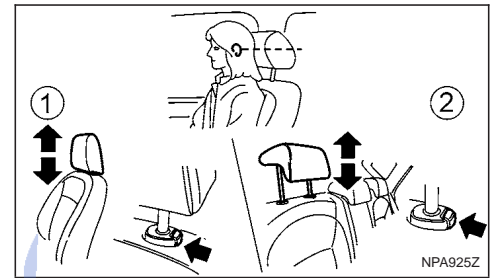

Front and Rear (where fitted) seat head restraints

Adjustment

1. Pull up the head restraint to raise to the proper position.
2. Push in the lock knob as illustrated to lower the head restraint to the proper position.

Adjust the head restraint so that the centre is level with your ears.

ACTIVE HEAD RESTRAINTS (front seats)

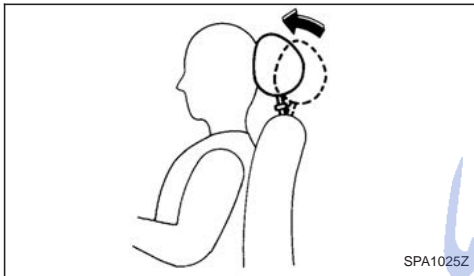

WARNING

- Always adjust the head restraints properly as specified in the previous section. Failure to do so can reduce the effectiveness of the active head restraint.
- Active head restraints are designed to supplement other safety systems. Always wear seat belts. No system can prevent all injuries in an accident.
- Do not attach anything to the head restraint stalks. Doing so could impair the active head restraint's function.

The head restraint moves forward utilising the force that the seatback receives from the occupant in a rear-end collision. The movement of the head restraint helps support the occupant's head by reduc-

ing its backward movement and by helping to absorb some of the forces that may lead to whiplash type injuries.

Active head restraints are effective for collisions at low to medium speeds in which it is said that whiplash injury occurs most.

Active head restraints operate only in certain rear-end collisions. After the collision, the head restraints return to their original positions.

Properly adjust the active head restraints as described in the previous section.

SEAT BELTS

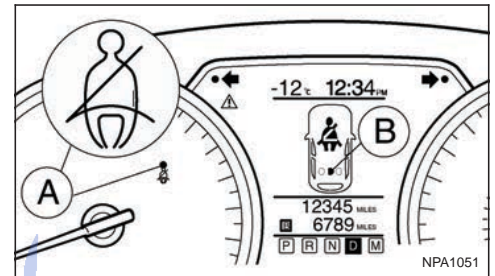

WARNING

7-seater: Seat belts for 3rd row seats are not part of the seat belt warning monitoring system.

SEAT BELT WARNINGS

(A) Driver and front passenger

The seat belt warning lights, located in the instrument panel (A), will light up if the driver and/or front passenger seat belts have not been fastened. See "Warning/indicator lights and audible reminders" in the "2. Instruments and controls" section for further details.

(B) Rear passengers

The rear passenger seat belt warning is shown in the vehicle information display (B). See "Vehicle information display" in the "2. Instruments and controls" section.

The seat belt warning alerts the driver and/or front passenger if a (rear) seat belt is not securely fas-



tened. The seat belt warning shows a filled circle when the ignition switch is turned to the ON position and an empty circle when the related seat belt has been securely fastened, or after approximately 35 seconds after engine start, or when acknowledged by the driver pushing the steering wheel switch ① (where fitted).

NOTE

- If there is a change in (2nd row) rear seat belt status during a journey then the applicable symbol for any unbuckled seat will show again for a further 35 seconds.
- The front passenger seat belt warning light will not illuminate if the seat is unoccupied.
- Seat belts for 3rd row seats (where fitted) are not part of the seat belt warning monitoring system.

PRECAUTIONS ON SEAT BELT USAGE

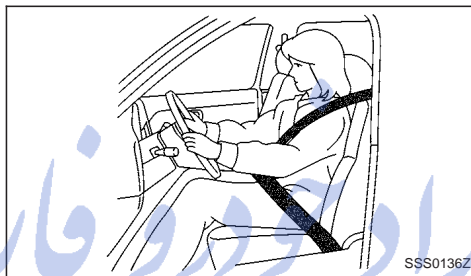

Sit upright and well back

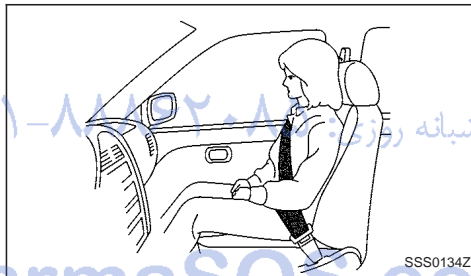

Sit upright and well back

Your chances of being injured in an accident and/or the severity of injury may be greatly reduced if you are wearing your seat belt and it is properly adjusted. NISSAN strongly encourages you and all of your passengers to buckle up every time you drive, even if your seating position is equipped with an air bag.

⚠ WARNING

Be sure to observe the following warnings when using seat belts. Failure to do so could increase the chance and/or severity of injury in an accident.

- Seat belts are designed to bear upon the bony structure of the body, and should be worn low across the front of the pelvis or the pelvis, chest and shoulders, as applicable; wearing the lap section of the belt across the abdominal area must be avoided.
- No modifications or additions should be made by the user which will either prevent the seat belt adjusting devices from operating to remove slack, or prevent the seat belt assembly from being adjusted to remove slack.
- Seat belts should be adjusted as firmly as possible, consistent with comfort to provide the protection for which they have been designed. A slack belt will greatly reduce the protection afforded to the wearer.
- Care should be taken to avoid contamination of the webbing with polishes, oils and chemicals, and particularly battery acid. Cleaning may safely be carried out using mild soap and water. The belt should be replaced if webbing becomes frayed, contaminated or damaged.
- It is essential to replace the entire assembly after it has been worn in a severe impact even if damage to the assembly is not obvious.

- Belts should not be worn with straps twisted.
- Each belt assembly must only be used by one occupant; it is dangerous to put a belt around a child being carried on the occupant's lap.
- Every occupant in this vehicle should wear a seat belt at all times.
- Never carry more people in the vehicle than there are seat belts.
- All seat belt assemblies, including retractors and attaching hardware, should be inspected by a NISSAN dealer or qualified workshop after any collision. NISSAN recommends that all seat belt assemblies in use during a collision should be replaced unless the collision was minor and the belts show no damage and continue to operate properly. Seat belt assemblies not in use during a collision should also be inspected and replaced if either damage or improper operation is noted.
- Once the pre-tensioner seat belt has been activated, it cannot be re-used. It must be replaced together with the retractor. See a NISSAN dealer or qualified workshop.
- Removal and installation of the pre-tensioner seat belt system components should be done by a NISSAN dealer or qualified workshop ONLY.
- If the seat belt warning light glows continuously while the ignition switch is in the ON position, all doors are closed and occupied seat belts are fastened, it may indicate a mal-

function in the system. Have the system checked by a NISSAN dealer or qualified workshop.

- Always route the shoulder belt over your shoulder and across your chest. Never run the belt under your arm. Serious injury can occur if the seat belt is not worn properly.
- Position the lap belt as low as possible AROUND THE HIPS, NOT THE WAIST.

CHILD SAFETY

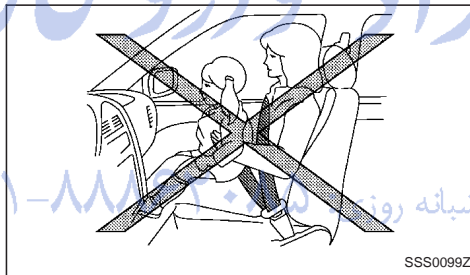

Infants or small children

NISSAN recommends that infants or small children should be seated in a child restraint on the rear seats if available. According to accident statistics, children are safer when properly restrained in the rear seat than in the front seat. See "Child restraints" later in this section. You should choose a child restraint system which fits your vehicle and always follow the manufacturer's instructions for installation and use.

Children

Children who are too large for child restraints should be seated and restrained by the seat belts that are provided.

The use of a booster seat (commercially available) may help to avoid the shoulder belt coming across the face or neck area of a child's seating position. The booster seat should raise the child so that the shoulder belt is properly positioned across the top, middle portion of the shoulder and the lap belt is low on the hips. The booster seat should fit the vehicle's seat. Once the child has grown so the shoulder belt is no longer on or near the face and neck, use the shoulder belt without the booster seat.



Never let a child stand or kneel on any seat and do not allow a child in the cargo areas while the vehicle is moving.

PREGNANT WOMEN

NISSAN recommends that pregnant women use seat belts. Contact your doctor for specific recommendations. The seat belt should be worn snug, always position the lap belt as low as possible around the hips, place the shoulder belt over your shoulder and across your chest. Never run the lap/shoulder belt over your abdominal area.



INJURED PERSONS

NISSAN recommends that injured persons use seat belts, depending on the injury. Check with your doctor for specific recommendations.

THREE-POINT TYPE SEAT BELTS

Every person who drives or rides in this vehicle should wear a seat belt at all times.

Fastening the seat belts

1. Adjust the seat.



WARNING

The seatback should not be reclined any more than needed for comfort. Seat belts are most effective when the passenger sits well back and upright in the seat. If the seat is reclined, the risk of sliding under the lap belt and being injured is increased.



2. Slowly pull the seat belt out of the retractor and insert the tongue into the buckle until it clicks.

CAUTION

The seat belt retractor is designed to lock during a sudden impact. A slow pulling motion will permit the belt to move and allow you some freedom of movement in the seat.

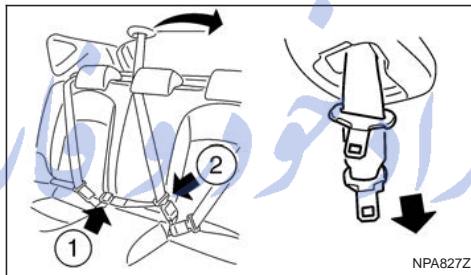

2nd row centre seat (5-seater)

2nd row centre seat (5-seater)

- a. Unclip the seat belt buckles from the ceiling stowage point.
- b. Slowly pull the seat belt out of the ceiling retractor and insert the end tongue into the buckle with the black button (1) until it clicks.
- c. Pull the tongue and insert it into the buckle (2) until it clicks.

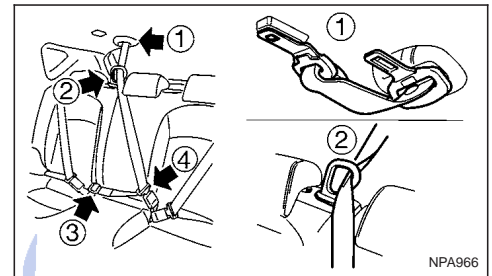

2nd row rear centre (7-seater)

2nd row centre seat (7-seater)

- a. Unclip the seat belt buckles from the (magnetic) ceiling stowage point (1).
- b. Slowly pull the seat belt out of the ceiling retractor and pass the buckles through the comfort loop (2).
- c. Insert the end tongue into the buckle with the black button (3) until it clicks.
- d. Pull the second tongue and insert it into the buckle with the red button (4) until it clicks.

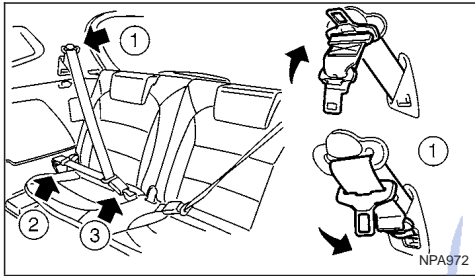

3rd row rear (7-seater)

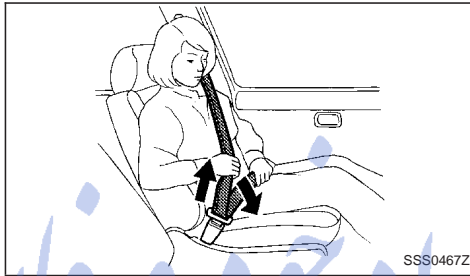

SSS0467Z

3rd row outer seat (7-seater)

- Unclip the end tongue from stowage hook on the side trim (1).
- Insert the end tongue into the buckle with the black button until it clicks (2).
- Pull the second tongue and insert it into the buckle with the red button (3) until it clicks. The tongue holder can be slid to a preferred position on the webbing for easy access the next time the seat belt is used.

- Position the lap belt portion low on the hips as shown.
- Pull the shoulder belt portion towards the retractor to take up extra slack. Make sure the shoulder belt is routed over your shoulder and snug across your chest.

WARNING

- The seat belt should rest on the middle of the shoulder. It must not rest against the neck.
- Make sure that the seat belt is not twisted in any way.

Unfastening the seat belts

WARNING

Make sure, when releasing the centre seat belt from the 2nd row, that the seat belt tongues do not come into contact with any occupants on the 3rd row.

To unfasten the seat belt, press the button on the buckle. The seat belt will automatically retract.

2nd row centre seat (5-seater)

Rear centre seat:

- Press the red button on the inner buckle (2). The seat belt will automatically retract to the outer buckle with the black button (1).
- To fully stow the seat belt, press the black button on the outer buckle (1). The seat belt will retract fully.
- Stow the seat belt buckles in the ceiling stowage point.

2nd row centre seat (7-seater)

- Press the red button on the inner buckle (4). The seat belt will automatically retract to the outer buckle with the black button (3).
- While holding the seat belt, press the black button on the outer buckle (3). The seat belt will retract fully.
- Stow the seat belt buckles in the ceiling stowage point.



3rd row outer seat (7-seater)

- a. Press the red button on the inner buckle ③. The seat belt will automatically retract to the outer buckle with the black button ②.
 - If desired, the 3rd row seatback can be folded flat for further information see “Folding 3rd row (7-seater)” earlier in this section.
- b. Press the black button to release the end tongue. When the seat belt has retracted fully, place the end tongue onto stowage hook ①. Move the tongue holder downwards if required.

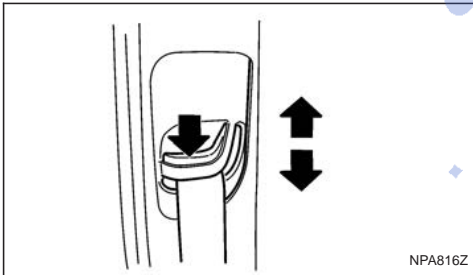

Shoulder belt height adjustment (front seats only)

The shoulder belt anchor height should be adjusted to the position best for you (see “Precautions on seat belt usage” earlier in this section).

To adjust, depress the adjustment button as illustrated and move the shoulder belt anchor to the appropriate position, so that the belt passes over

the centre of the shoulder. Release the adjustment button to lock the shoulder belt anchor into position.



WARNING

- After adjustment, release the adjustment button and check by moving the shoulder belt assembly up and down to make sure the shoulder belt anchor is securely fixed in position.
- The seat belt should be away from your face and neck, but not falling off your shoulder.

Checking the seat belt operation

Your seat belt retractors are designed to lock the belt movement in two separate situations:

- When the belt is pulled quickly from the retractor.
- When the vehicle slows down rapidly.

To increase your confidence in the belts, check the operation as follows:

Take place in the seat for which you wish to check the belt operation. Grasp the shoulder belt and pull quickly forward. The retractor should lock and restrict further belt movement.

If the retractor does not lock during these checks or if you have any questions about the seat belt operation, see a NISSAN dealer or qualified workshop.

SEAT BELT MAINTENANCE

- To clean the seat belt webbing, apply a mild soap solution or any solution recommended for cleaning upholstery or carpets. Then brush it, wipe with a cloth and allow it to dry in the shade. Do not allow the seat belts to retract until they are completely dry.
- If dirt builds up in the shoulder belt guide of the seat belt anchors, the seat belts may retract slowly. Wipe the shoulder belt guide with a clean, dry cloth.
- Periodically check to see whether the seat belt and the metal components such as buckles, tongues, retractors, flexible wires and anchors work properly. If loose parts, deterioration, cuts or other damage to the webbing is found, the entire belt assembly should be replaced.

PRE-TENSIONER SEAT BELT SYSTEM



WARNING

- The pre-tensioner seat belt cannot be reused after activation. It must be replaced together with the retractor as a unit.
- If the vehicle is involved in a frontal collision but the pre-tensioner is not activated, be sure to have the pre-tensioner system checked and, if necessary, replaced by a NISSAN dealer or qualified workshop.
- No unauthorised changes should be made to any components or wiring of the pre-tensioner seat belt system. This is to prevent accidental activation of the pre-tensioner seat belt or damage to the pre-tensioner seat belt operation. Tampering with the pre-tensioner seat belt system may result in serious personal injury.
- Work on and around the pre-tensioner system should be done by an authorised NISSAN dealer or qualified workshop. Installation of electrical equipment should also be done by a NISSAN dealer or qualified workshop. Unauthorised electrical test equipment and probing devices should not be used on the pre-tensioner seat belt system.
- If you need to dispose of the pre-tensioner or scrap the vehicle, contact a NISSAN dealer or qualified workshop. Correct pre-tensioner disposal procedures are set forth in the ap-

propriate NISSAN Service Manual. Incorrect disposal procedures could cause personal injury.

The front seat pre-tensioner seat belt system is activated in conjunction with the front air bag system. It helps tighten the seat belt when the vehicle is involved in certain types of collisions by restraining the seat occupants via the seat belt retractor.

The pre-tensioner is encased with the seat belt's retractor. These seat belts are used in the same way as conventional seat belts.

Additionally, the driver's side pre-tensioner seat belt system is also equipped with a lap pre-tensioner. Both the retractor pre-tensioner and lap pre-tensioner provide significant protection against injury in an accident and increase the safety performance of your vehicle.

When the pre-tensioner seat belt system activates, smoke is released and a loud noise may be heard. The smoke is harmless, but care should be taken not to inhale it as it may cause irritation and choking.

When the ignition switch is in the ON or START position, the Supplemental Restraint System (SRS) air bag warning light will illuminate. The SRS air bag warning light will turn off after approximately 7 seconds if the system is operational. If any of the following conditions occur, the air bag and/or pre-tensioner seat belt need servicing and your vehicle must be taken to the nearest NISSAN dealer or qualified workshop.

- The air bag warning light remains on after approximately 7 seconds.
- The air bag warning light flashes intermittently.
- The air bag warning light does not come on at all.

Unless checked and repaired, the Supplemental Restraint System (SRS) and/or pre-tensioner seat belt may not function properly. It must be checked and repaired.

When selling your vehicle, we request that you inform the buyer about the pre-tensioner seat belt system and guide the buyer to the appropriate sections in this Owner's Manual.



SUPPLEMENTAL RESTRAINT SYSTEM (air bag system)

This Supplemental Restraint System (SRS) section contains important information concerning the driver and front passenger air bags, side air bags, curtain air bags and pre-tensioner seat belt system.

Front air bag system: this system can help cushion the impact force to the face and chest of the driver and front passenger in certain frontal collisions.

NOTE

For further information about the front passenger air bag deactivation system see "Front passenger air bag deactivation system" later in this section.

Side air bag system: this system can help cushion the impact force to the chest area of the driver and front passenger in certain side impact collisions. The side air bag is designed to inflate on the side where the vehicle is impacted.

Curtain air bag system: this system can help cushion the impact force to the head of an occupant in the front and rear outer seating position. Curtain air bags are designed to inflate on the side where the vehicle is impacted.

SRS is designed to **supplement** the crash protection provided by the driver and front passenger seat belts and is **not designed to substitute** them. Seat belts should always be correctly worn and the driver and front passenger seated a suitable distance away from the steering wheel, instrument panel and front door finishers. For additional information, see "Seat belts" earlier in this section.

After turning the ignition switch to the ON or

START position, the air bag warning light will illuminate. The air bag warning light will turn off after approximately 7 seconds if the system is operational. See "Warning/indicator lights and audible reminders" in the "2. Instruments and controls" section for further details.

The air bag will operate only when the ignition switch is in the ON or START position.



WARNING

Driver and front passenger air bags:

- The air bags ordinarily will not inflate in the event of a side impact, rear impact, roll over, or lower severity frontal collision. Always wear your seat belts to help reduce the risk or severity of injury in various kinds of accidents.
- The seat belts and the air bags are most effective when you are sitting back and upright in the seat. Air bags inflate with great force. If you are unrestrained, leaning forward, sitting sideways or out of position in any way, you are at greater risk of injury or death in a crash and may also receive serious or fatal injuries from the air bag if you are up against it when it inflates.

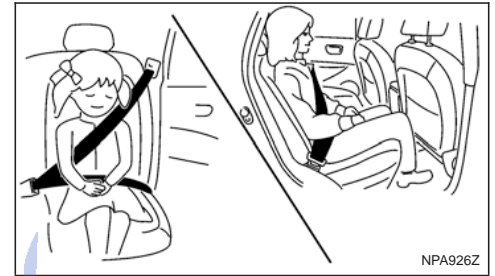

Correct (rear) seating positions



WARNING

- Never let children ride unrestrained or extend their hands or face out of the window. Do not attempt to hold them on your lap or in your arms. Some examples of dangerous riding positions are shown in the previous illustrations.
- Children may be severely injured or killed if not properly restrained when the supplemental front air bags or supplemental side air bags inflate. Preteens and children should be properly restrained in the rear seat if possible.

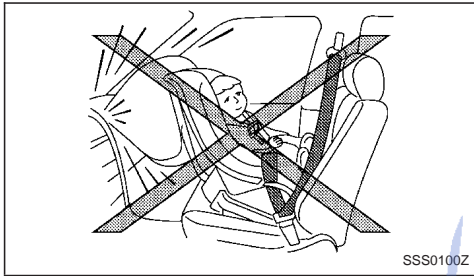

- Never install a child restraint in the front seat without first deactivating the front passenger air bag. An inflating supplemental front air bag could seriously injure or kill your child. For additional information, see "Child restraints" later in this section.

WARNING

Side and curtain air bags:

- The side and curtain air bag ordinarily will not inflate in the event of a frontal impact, rear impact or lower severity side collision. Always wear your seat belts to help reduce the risk or severity of injury in various kinds of accidents.
- The seat belts, side and curtain air bags are most effective when you are sitting well back and upright in the seat. Side and curtain air bags inflate with great force. Do not allow anyone to place hands, legs or face near the side and curtain air bags. Do not allow anyone sit-

ting in the front seat to extend their hand out of the window or lean against the door.

- When sitting in the rear seat, do not hold onto the seatback of the front seat. If the side air bag inflates, the occupant may be seriously injured. Be especially careful with children, who should always be properly restrained.
- Do not use seat covers on the front seatbacks. They may interfere with side air bag inflation.

NOTE

For an overview see "Air bag system" in the "0. Illustrated table of contents" section.

AIR BAG SYSTEM

Front air bags

The driver's air bag is located in the centre of the steering wheel; the front passenger air bag is mounted in the dashboard above the glove box. The air bags are designed to inflate in higher severity frontal collisions, although they may inflate if the forces in another type of collision are similar to those of a higher severity frontal impact. They may not inflate in certain frontal collisions. Conclusions should not be drawn on the air bag's operation according to the vehicle's state.

When the supplemental front air bags inflate, a fairly loud noise may be heard, followed by a release of smoke. This smoke is not harmful and does not indicate a fire. However, care should be taken not to inhale it, as it may cause irritation and choking. Oc-

cupants with a history of breathing difficulties, such as asthma, should get fresh air promptly.

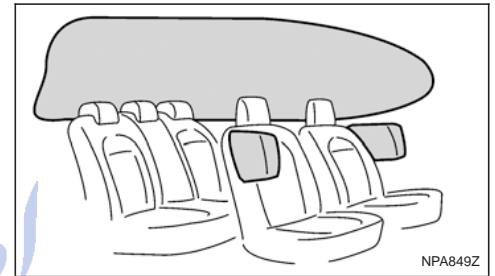

5-seater

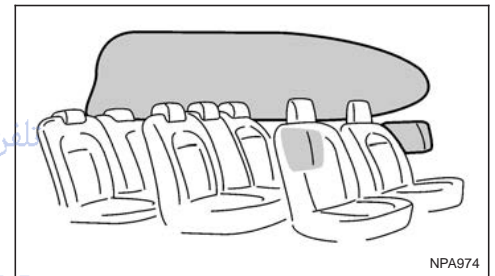

7-seater

Side and curtain air bags

The supplemental side air bags are located in the outside of the seatback of the front seats. The supplemental curtain air bags are located in the roof side trims. The supplemental side air bags and curtain air bags are designed to inflate in higher severity side collisions, although they may inflate if the



forces in another type of collision are similar to those of a higher severity side impact. They are designed to inflate on the side where the vehicle is impacted. They may not inflate in certain side collisions. Vehicle damage (or lack of it) is not always an indication of proper supplemental side air bag operation.

When the supplemental side air bag and curtain air bag inflate, a fairly loud noise may be heard, followed by a release of smoke. This smoke is not harmful and does not indicate a fire. However, care should be taken not to inhale it, as it may cause irritation and choking. Occupants with a history of breathing difficulties, such as asthma, should get fresh air promptly.

Supplemental side air bags, along with the use of seat belts, help to cushion the impact force on the chest of the front occupants. Curtain air bags help to cushion the impact force to the head of occupants in the front and rear outer seating positions. They can help save lives and reduce serious injuries. However, an inflating side air bag and curtain air bag may cause abrasions or other injuries. Supplemental side air bags and curtain air bags do not provide restraint to the lower body.

The seat belts should be correctly worn and the driver and passenger seated upright, and as far as is practical, away from the side air bag. Rear seat passengers should be seated as far away as practical from the door finishers and side roof rails. The side air bags and curtain air bags inflate quickly in order to help protect the front occupants. Because of this, the force of the side air bag and curtain air bag inflating can increase the risk of injury if the

occupant is too close to, or is against, these air bag modules during inflation. The side air bag and curtain air bag will deflate quickly after the collision is over.

⚠ WARNING

- **Directly after inflation, several air bag system components will be hot. Do not touch them; you may severely burn yourself.**
- **No unauthorised changes should be made to any components or wiring of the air bag system. This is to prevent accidental inflation of the air bag or damage to the air bag system.**
- **Tampering with the air bag system may result in serious personal injury. Tampering includes making changes to the steering wheel and the instrument panel assembly by placing material over the steering pad and above the dashboard, or by installing additional trim material around the air bag system.**
- **Do not attach any objects to the steering wheel pad or to the instrument panel. Objects attached to the steering wheel pad and instrument panel may become dangerous projectiles and cause injury if the air bag inflates.**
- **Work on and around the air bag system should be done by a NISSAN dealer or qualified workshop. Installation of electrical equipment should be done by a NISSAN dealer or qualified workshop. The yellow SRS wiring harnesses* should not be modified or discon-**

ected. Unauthorised electrical test equipment and probing devices should not be used on the air bag system.

- * **SRS wiring harnesses are covered with yellow insulation either just before the harness connectors or on the complete harness, for easy identification.**

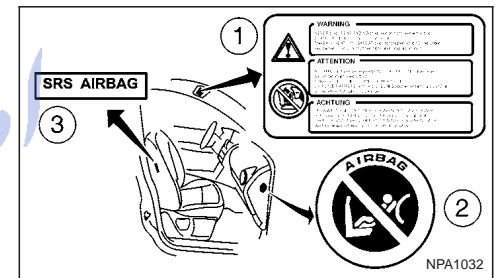

- ① SRS air bag warning labels
The warning labels are located on the surface of the sun visor.
- ② SRS front passenger air bag warning label
The warning label is located on the outer side of the instrument panel (passenger side).
- ③ SRS side air bag warning label
The warning label is located on the side of the passenger side centre pillar.
Tags are also sewn into the front seat covers.

AIR BAG WARNING LABELS

Warning labels about the air bag system are placed in the vehicle. Warning labels are for your safety and the safety of your passengers; do not remove them.

Child restraint on front passenger seat

NISSAN recommends that infants or small children be seated in a child restraint system on the rear seat if available. According to accident statistics, children are safer when properly restrained in the rear seat rather than in the front seat.

Front passenger air bag:

Your vehicle is equipped with a front passenger air bag, you will find an air bag warning label attached to the passenger side of the instrument panel as shown in the previous illustration.

This label warns:

“Extreme Hazard! Do not use a rearward facing child restraint on a seat protected by an air bag in front of it!”

This label warns NOT to fit a rearward facing child restraint on the front passenger seat without first deactivating the front passenger air bag.

For instructions on deactivating the front passenger air bag see “Front passenger air bag deactivation system” later in this section.

When installing child restraints in your vehicle, always carefully observe the manufacturer’s instructions.

For more details on the installation of child restraints, see also “Child restraints” later in this section.

Side air bags:

Your vehicle is equipped with side air bags. You will find a side air bag warning label attached to the vehicle’s interior as shown in the previous illustration.

This label warns you not to let infants or small children sit on the front passenger seat as the air bag may cause serious injury in case of deployment during a collision.

AIR BAG WARNING LIGHT

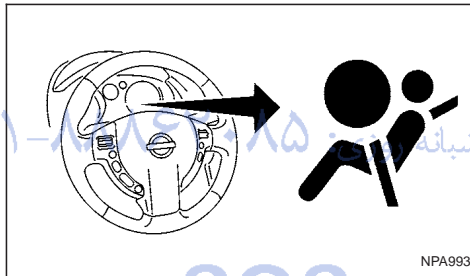

The Supplemental Restraint System (SRS) air bag warning light, displaying  in the instrument panel, monitors the circuits of the front air bag system, the side and curtain air bag systems and the pre-tensioner seat belt system. The circuits monitored by the SRS air bag warning light are: all sensors, air bag modules and all related wiring, and the pre-tensioner seat belt.

After turning the ignition switch to the ON or START position, the supplemental air bag warning light illuminates. The air bag warning light will turn off after approximately 7 seconds if the system is operational.

Take your vehicle to the nearest NISSAN dealer or qualified workshop to have the air bag systems and pre-tensioner seat belt serviced if the SRS air bag warning light:

- Remains on after approximately 7 seconds
- Flashes intermittently
- Does not come on at all

Under these conditions, the front air bags, side and curtain air bags and/or pre-tensioner seat belt will not operate properly. They must be checked and repaired.

Repair and replacement procedure

The front air bags, side air bags, curtain air bags, and pre-tensioner seat belt system are designed to activate on a one-time-only basis. As a reminder, unless it is damaged, the air bag warning light will remain illuminated after inflation has occurred. Repair and replacement of the air bag system should be done only by a NISSAN dealer or qualified workshop.

When maintenance work is required on the vehicle, the air bag systems, related parts and pre-tensioner seat belt should be pointed out to the person con-



ducting the maintenance. The ignition switch should always be in the LOCK position when working under the bonnet or inside the vehicle.

WARNING

- Once the air bag has inflated or the pre-tensioner seat belt has been activated, the air bag module and pre-tensioner seat belt will not function again and must be replaced. The air bag module should be replaced by a NISSAN dealer or qualified workshop. The air bag module cannot be repaired.
- All air bag systems should be inspected by a NISSAN dealer or qualified workshop if there is any damage to the front end portion of the vehicle.
- When selling your vehicle, we request that you inform the buyer about the air bag system and guide the buyer to the appropriate sections in this Owner's Manual.
- If you need to dispose of an air bag or scrap the vehicle, contact a NISSAN dealer or qualified workshop. Correct air bag disposal procedures are set forth in the appropriate NISSAN Service Manual. Incorrect disposal procedures could cause personal injury.

FRONT PASSENGER AIR BAG INDICATOR LIGHT

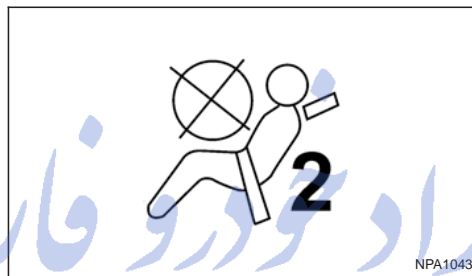

WARNING

- Since your vehicle is equipped with a front passenger air bag, it is not permitted to install a rearward facing child restraint on the front passenger seat unless the front passenger air bag has been deactivated first.
- Do not fit a rearward facing child seat on the front passenger seat if the air bag activation/deactivation system is malfunctioning. Your vehicle must immediately be taken to a NISSAN dealer or qualified workshop in such a situation.

The front passenger air bag indicator light , located in the combination meter, illuminates for approximately 7 seconds and then goes off. This means the system is operational.

The front passenger air bag indicator light warns of

front passenger air bag status. If the front passenger air bag has been deactivated, the light comes on and stays on as long as the front passenger air bag switch remains in the OFF position.

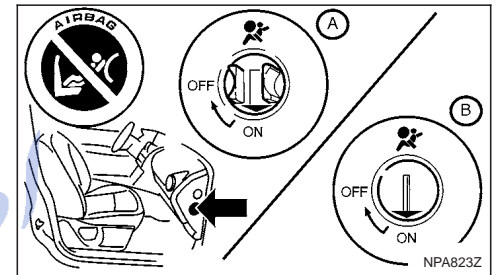

- (A) Intelligent Key equipped models
- (B) Integrated keyfob equipped models

Front passenger air bag deactivation system

To fit a rear facing child restraint on the front passenger seat, you must deactivate the front passenger seat air bag system:

1. With the ignition switch in the LOCK position and the engine off, open the front passenger door.
2. Insert the ignition key/emergency key (Intelligent Key equipped models see "Emergency/mechanical")

cal key (Intelligent Key models)" later in this section) in the front passenger air bag switch on the side of the dashboard, press then turn the key to the OFF position.

3. Turn the ignition switch to the ON position and make sure the front passenger air bag indicator light  remains illuminated.

The  indicator light remains continuously illuminated to warn you of front passenger air bag status.

See "Child restraints" later in this section for child seat appropriate fitting.

Activating the front passenger air bag

You should reactivate the front passenger air bag system as soon as the child restraint is not in use on the front passenger seat to ensure protection of the front passenger seat occupant in the event of an impact.

To reactivate the front passenger air bag system:

1. With the ignition switch in the LOCK position and the engine off, open the front passenger door.
2. Insert the ignition key/emergency key (Intelligent Key equipped models) in the front passenger air bag switch and turn the key to the ON position.
3. Turn the ignition switch to the ON position and make sure the front passenger air bag indicator light  illuminates for a few seconds and then turns off.

WARNING

If any of the following conditions occur after the ignition switch has been turned to the ON position, the front passenger air bag system needs servicing and your vehicle must be taken to the nearest NISSAN dealer or qualified workshop.

- The front passenger air bag indicator light comes on and remains illuminated after approximately 7 seconds while the front passenger air bag switch is ON.
- The front passenger air bag indicator light does not come on at all while the front passenger air bag switch is ON.

Unless checked and repaired, the front passenger air bag system may not function properly.

CHILD RESTRAINTS

PRECAUTIONS ON CHILD RESTRAINT USAGE

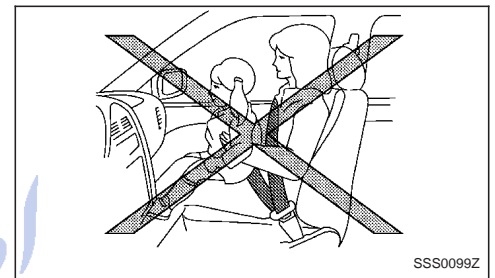

Infants and small children should **always** be placed in an infant or child restraint while riding in the vehicle.

WARNING

- Infants and small children should never be carried on your lap. It is not possible for even the strongest adult to resist the forces of an accident. The child could be crushed between the adult and parts of the vehicle. Also, do not put the same seat belt around a child and yourself. In general, child restraints are designed to be installed with the lap portion of a three-point type seat belt.
- NISSAN recommends installing the child restraint on the rear seat. According to accident statistics, children are safer when properly restrained in the rear seat than in the front seat.



- **An improperly installed child restraint could lead to serious injury in an accident.**

Child restraints specially designed for infants and small children are offered by several manufacturers. When selecting any child restraint, keep the following points in mind:

- Choose a child restraint that complies with the latest European safety standard, ECE Regulation 44.04.
- Place your child in the child restraint and check the various adjustments to be sure that the child restraint is suitable for your child. Always follow all of the recommended procedures.
- Check the child restraint in your vehicle to be sure it is compatible with the vehicle's seat belt system.
- Refer to the tables further on in this section for a list of the recommended fitment positions and the approved child restraint for your vehicle.

 **WARNING**

- **Never install a rear facing child restraint in the front seat without first deactivating the front passenger air bag.**
- **Adjustable seatbacks should be positioned to fit the child seat; however, the seatback should be as upright as possible.**
- **Follow all of the child restraint manufacturer's instructions for installation and use.**

- **Choose a child restraint appropriate to the child and the vehicle. It may not be possible to properly install some types of child restraint in your vehicle.**
- **Improper use of a child restraint can increase injuries to the infant or child and other occupants in the vehicle.**
- **When your child restraint is not in use, keep it secured with a seat belt to prevent it from being thrown forwards in case of a sudden stop or accident.**
- **Remember that a child restraint left in a closed vehicle can become very hot. Check the seating surface and buckles before placing your child in the child restraint.**
- **After attaching a child restraint, test the seat before you place the child in it. Check that it does not tilt too far from side to side. Try to tug it forwards and check whether the belt holds it in place. If the restraint is not secure, tighten the belt as necessary, or put the restraint in another seat and test it again.**
- **If the child restraint is not anchored properly, the risk of a child being injured in a collision or sudden stop greatly increases.**
- **The front passenger seat should be positioned to fit the child seat appropriately. See "Installation of a child restraint system on the front passenger seat" later in this section.**
- **For a front facing child restraint installed on a three-point type lap/shoulder belt, make sure**

the shoulder belt does not go in front of the child's face or neck. If it does, put the shoulder belt behind the child restraint.

- **If the child restraint is equipped with a locking clip, ensure that the clip is securely fastened to the vehicle seat belt. If the locking clip is not used, injuries could result from the child restraint tipping over during normal vehicle braking or cornering.**

Approved child restraint positions

Age group	Seating position: 5-seater		
	Front passenger seat with deactivated front passenger air bag ONLY	Rear centre seat	Rear outer seat
Group 0+ (< 13 kg)	L*	U*	U* or I*
Group I (9 to 18 kg)	L	U	U or I
Group II and III (15 to 36 kg)	L	U	U

U: Suitable for "Universal" category approved in this age group.

NOTE

Make sure the front passenger seat is adequately positioned. See "Installation of a child restraint system on the front passenger seat" later in this section.

I: Suitable for "ISOFIX (with top tether)" category given in the following table.

L: Suitable for particular child restraints given in the following table. The restraints may be of the specific vehicle, restricted, semi-universal or universal categories.

* Rearward facing ONLY

امداد خودرو فارما
 تلفن شبانه روزی: ۰۲۱-۸۸۸۶۲۰۸۵
 FarmaSOS.com



Age group	Seating position: 7-seater			
	Front passenger seat with deactivated front passenger air bag ONLY	2nd row centre seat	2nd row outer seat	3rd row seat
Group 0+ (< 13 kg)	L*	L*	L or I*	X
Group I (9 to 18 kg)	L	L	L or I	L
Group II and III (15 to 36 kg)	L	L	L	L

I: Suitable for "ISOFIX (with top tether)" category given in the following table.

L: Suitable for particular child restraints given in the following table. The restraints may be of the specific vehicle, restricted, semi-universal or universal categories.

*: Rearward facing ONLY

X: Not suitable for child restraint for this age group

تلفن شبانه روزی: ۰۲۱-۸۸۸۶۲۰۸۵

FarmaSOS.com

List of approved ISOFIX and specific Universal child restraints

Age group	Seating position: 5-seater		
	Front passenger seat with deactivated front passenger air bag ONLY	Rear centre seat	Rear outer seat
Group 0+ (< 13 kg)	Britax Cosy Tot Romer Baby-Safe *1, *3	Britax Cosy Tot Romer Baby-Safe *1, *3	Fair G 0/1 *1, *2
Group I (9 to 18 kg)	Fair G 0/1 *3 Britax/Romer Duo Plus *3	Fair G 0/1 *3 Britax/Romer Duo Plus *3	Fair G 0/1 *2
Group II and III (15 to 36 kg)	Britax Hi Liner Romer Kid *3	Britax Hi Liner Romer Kid *3	Britax Hi Liner Romer Kid *3

*1: Rearward facing only.

*2: This is an ISOFIX child restraint. It requires an additional platform to be fitted to your vehicle:
Rearward facing use Platform RWFA
Forward facing use Platform FWFD
Alternatively, refer to a NISSAN dealer or qualified workshop for the latest platform references.

*3: Universal mode only.

WARNING

- Never install a rear facing child restraint system in the front seat without first deactivating the front passenger air bag. Supplemental front-impact air bags inflate with great force. A child restraint system could be struck by the supplemental front-impact air bag in an accident and could seriously injure or kill your child.
- Your vehicle is equipped with a side air bag system: Do not let infants or small children sit in the front passenger seat as the air bag may cause serious injury in case of deployment during a collision.

NOTE

Universal child restraints approved to ECE Regulation No. 44.04 are clearly marked "Universal".

FarmaSOS.com



Age group	Seating position: 7-seater			
	Front passenger seat with deactivated front passenger air bag ONLY	2nd row centre seat	2nd row outer seat	3rd row seat
Group 0+ (< 13 kg)	Britax Cosy Tot Romer Baby-Safe *1, *3	Britax Cosy Tot Romer Baby-Safe *1, *3	Fair G 0/1 *1, *2	X
Group I (9 to 18 kg)	Britax/Romer Duo Plus *3	Britax/Romer Duo Plus *3 Fair 123 Bimbo	Fair G 0/1 *2 Maxi-Cosi Tobi Fair 123 Bimbo	Fair 123 Bimbo Maxi-Cosi Tobi
Group II and III (15 to 36 kg)	Britax Hi Liner Romer Kid *3	Britax Hi Liner Romer Kid *3 Fair Junior	Britax Hi Liner Romer Kid *3 Fair Junior	Fair Junior

*1: Rearward facing only.

*2: This is an ISOFIX child restraint. It requires an additional platform to be fitted to your vehicle.
Rearward facing use Platform RWF B/D
Forward facing use Platform FWF B
Alternatively, refer to a NISSAN dealer or qualified workshop for the latest platform references.

*3: Universal mode only.

X: Not suitable for child restraint for this age group

INSTALLATION OF A CHILD RESTRAINT SYSTEM ON THE FRONT PASSENGER SEAT

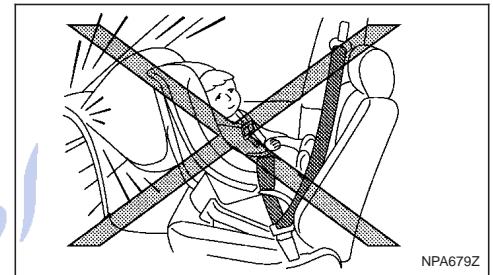

WARNING

- Never install a rear facing child restraint system in the front seat without first deactivating the front passenger air bag. Supplemental front-impact air bags inflate with great force. A child restraint system could be struck by the supplemental front-impact air bag in an accident and could seriously injure or kill your child.
- NISSAN recommends that infants or small children be seated in a child restraint system in the rear seat. According to accident statistics, children are safer when properly restrained in the rear seat than in the front seat.

Rear facing

If you must install a child restraint system in the front seat, follow these steps:

1. Deactivate the front passenger air bag. See "Front passenger air bag deactivation system" earlier in this section for further details.
2. Move the seat to the rearmost position.
3. Adjust the head restraint to its highest position. Remove it if it interferes with the child restraint installation. In such situations, securely store the head restraint in the luggage compartment so that it does not become a dangerous projectile during a sudden stop or in an accident.
4. Position the child restraint system in the front passenger seat.

Always follow the child restraint system manufacturer's instructions for installation and use.

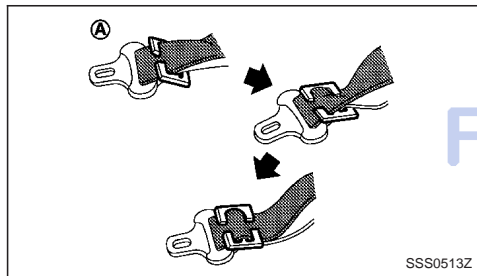

5. Route the seat belt tongue through the child restraint system and insert it into the buckle until you hear and feel the latch engage.

To prevent slack in the lap belt, secure the shoulder belt in place with a locking clip (A). Use a locking clip attached to the child restraint system, or one which is equivalent in dimensions and strength.

Be sure to follow the child restraint system manufacturer's instructions for belt routing.

6. Slide the seat forwards so that the seat belt fully tightens the child restraint system and the child restraint reaches the vehicle dashboard.
7. Test the child restraint system before you place the child in it. Check that it does not tilt too far from side to side. Try to tug it forwards and check if it is held securely in place.

INSTALLATION OF A CHILD RESTRAINT SYSTEM ON REAR SEATS

WARNING

- NISSAN recommends that infants or small children be seated in a child restraint system. According to accident statistics, children are safer when properly restrained in the rear seat than in the front seat.
- The direction of the child restraint system depends on the type of the child restraint system and the size of the child.

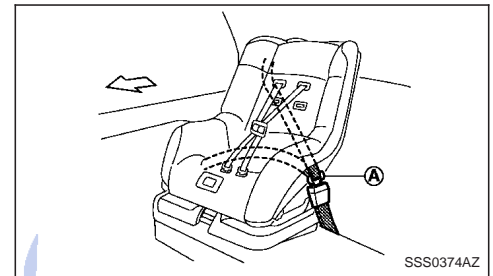

Rear outer seat (5-seater)

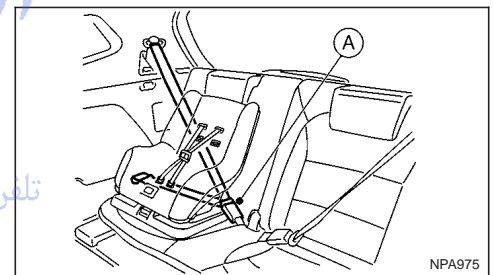

Rear seat (7-seater)

Front-facing

When you install a front-facing child restraint system in a rear outer or centre seat, follow these steps:

1. **5-seater:** Position the front passenger seat as far forwards as possible.



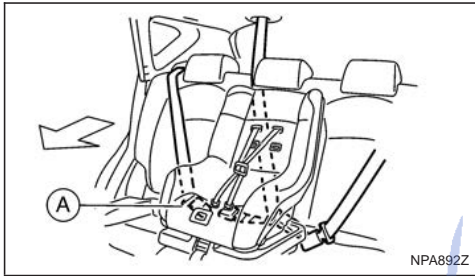

Rear centre seat (5-seater)

sary to secure the shoulder belt in place with a locking clip (A). Use a locking clip attached to the child restraint system, or one which is equivalent in dimensions and strength.

Be sure to follow the child restraint system manufacturer's instructions for belt routing.

4. Test the child restraint system before you place the child in it. Check that it does not tilt too far from side to side. Try to tug it forwards and check if it is held securely in place.
5. Check to make sure that the child restraint system is properly secured prior to each use.

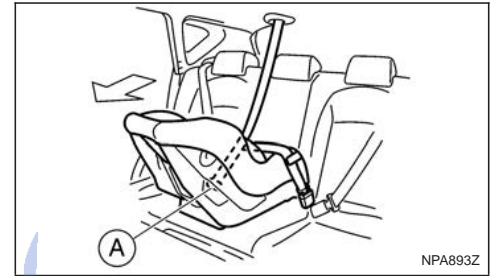

Rear centre seat (5-seater)

2. Position the front-facing child restraint system on the rear seat.

Always follow the child restraint system manufacturer's instructions for installation and use.

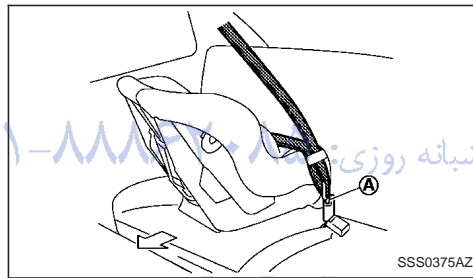
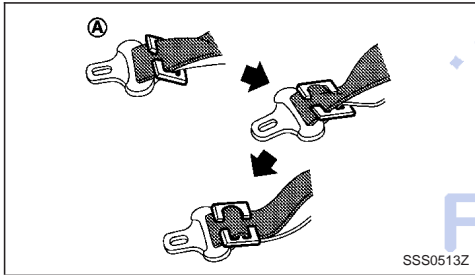

Rear outer seat (5-seater)

Rear-facing

When you install a rear-facing child restraint system in a rear outer or centre seat, follow these steps:

1. **5-seater:** Slide the front passenger seat as far backwards as possible.

2. Position the rear-facing child restraint system on the rear seat.

Always follow the child restraint system manufacturer's instructions for installation and use.

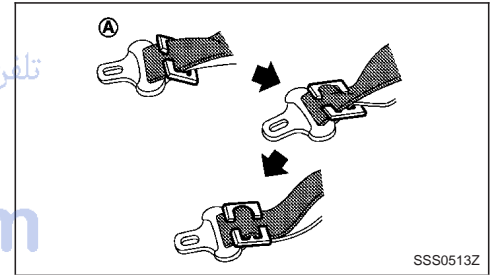

3. Route the seat belt tongue through the child restraint system and insert it into the buckle until you hear and feel the latch engage.

To prevent slack in the lap belt, it will be neces-

3. Route the seat belt tongue through the child restraint system and insert it into the buckle until you hear and feel the latch engage.

To prevent slack in the lap belt, it will be neces-

sary to secure the shoulder belt in place with a locking clip (A). Use a locking clip attached to the child restraint system, or one which is equivalent in dimensions and strength.

Be sure to follow the child restraint system manufacturer's instructions for belt routing.

4. Test the child restraint system before you place the child in it. Check that it does not tilt too far from side to side. Try to tug it forwards and check if it is held securely in place.
5. Check to make sure that the child restraint system is properly secured prior to each use.

ISOFIX SYSTEM (where fitted)

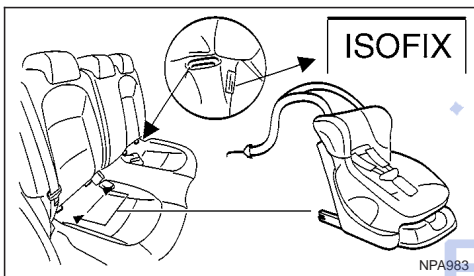

WARNING

- **Attach ISOFIX compatible child restraint systems only at the locations shown. If a child restraint is not secured properly, your child could be seriously injured or killed in an accident.**

- **The rear seat is equipped with 2 ISOFIX compatible child restraint systems, on both outer seats ONLY. Do not secure a child restraint in the rear centre seating position using the child restraint lower anchors. The child restraint will not be secured properly.**
- **The ISOFIX system anchors are designed to withstand only those loads imposed by correctly fitted child restraints. Under no circumstances are they to be used for adult seat belts or harnesses.**

Some child restraints include two rigid or webbing-mounted attachments that can be connected to two anchors located at certain seating positions in your vehicle. This system is known as the ISOFIX or ISOFIX compatible system. With this system, you do not have to use a vehicle seat belt to secure the child restraint. Your vehicle is equipped with special anchor points that are used with ISOFIX system compatible child restraints on the rear seat. Check your child restraint for a label stating that it is compatible with the ISOFIX system. This information may also be in the child restraint owner's manual. If you have such a child restraint, refer to the illustration for the rear seating positions equipped with ISOFIX system anchors which can be used to secure the child restraint.

The ISOFIX system anchors are located at the rear of the seat cushion near the seatback on the rear seat. Labels are attached to the seat cushion to help you locate the ISOFIX system anchors (as illustrated).

CAUTION

- **The child restraint may also require the use of a top tether strap. See "Top tether strap for child restraint" later in this section for installation instructions. Alternatively, the child restraint may require an anti-rotation device such as support leg. Refer to the child restraint system manufacturer's instructions.**
- **When installing a child restraint, carefully read and follow the instructions in this manual and those supplied with the child restraint.**

When you install an ISOFIX system compatible child restraint to the lower anchor attachments in the rear seat, follow these steps:

1. Inspect the lower anchors by inserting your fingers into the lower anchor area and make sure there are no obstructions over the ISOFIX system anchors, such as seat belt webbing or seat cushion material. The child restraint will not be secured properly if the ISOFIX system anchors are obstructed.
2. To install the ISOFIX system compatible child restraint, insert the child restraint ISOFIX system anchor attachments into the anchor points on the rear seat. See "Top tether strap for child restraint" later in this section for installation instructions.
3. Fit the ISOFIX funnel guides (supplied with the



ISOFIX child seat – where fitted) to the vehicle ISOFIX brackets located in slots on the slope of the rear outer seat cushions (refer to the ISOFIX label for appropriate locations).

4. After attaching the child restraint and before placing the child in it, use force to check that it does not tilt too far from side to side and tug it forward to make sure that the child restraint is securely held in place. Make sure that both ISOFIX anchorages have latched correctly.
5. Make sure that the child restraint is properly secured prior to each use.

NOTE

- For forward facing ISOFIX child restraint position on the rear seat, slide the front seat as far forwards as possible.
- For rearward facing ISOFIX child restraint position on the rear seat, slide the front seat backwards until it touches the edge of the child restraint.

TOP TETHER STRAP FOR CHILD RESTRAINT

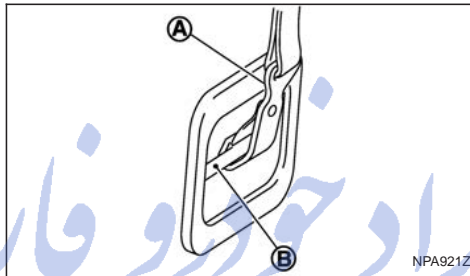

- (A) Top tether clip
- (B) Child restraint anchor bar

The top tether strap of the child restraint must be secured to the provided anchor point of your vehicle (see “Anchor point locations (where fitted)” later in this section).

Installing top tether strap

1. Adjust the head restraint to the upper position.
2. Position the top tether strap over the top of the seatback beneath the head restraint. Secure the top tether hook to the tether anchor bracket that provides the straightest installation. Tighten the strap according to manufacturer’s instructions to remove any slack.

WARNING

- Child restraint anchorages are designed to withstand only those loads imposed by correctly fitted child restraints. Under no circumstances are they to be used for adult seat belts, harnesses or for attaching other items or equipment to the vehicle.
- The child restraint top tether strap may be damaged by contact with the rear parcel shelf or items in the luggage compartment area. Remove the rear parcel shelf from the vehicle or secure it in the luggage compartment area see “Rear parcel shelf (where fitted)” later in this section. Also, secure any loose items in the luggage compartment. Your child could be seriously injured or killed in a collision if the top tether strap is damaged.

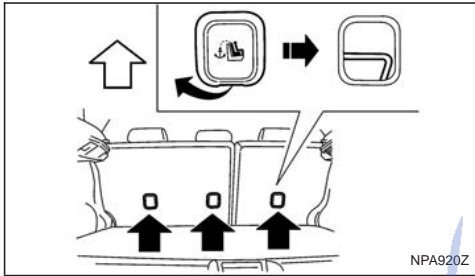

NPA920Z

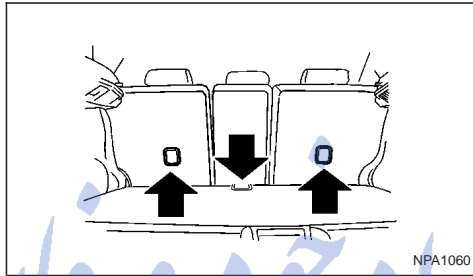

NPA1060

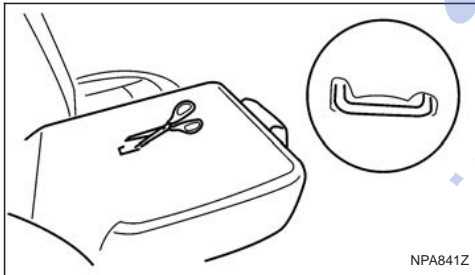

NPA841Z

5-seater

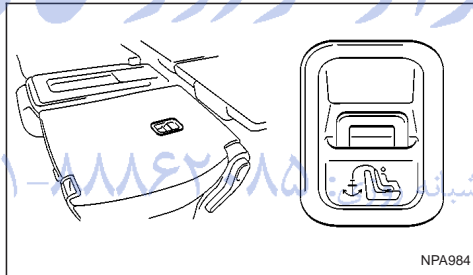

NPA984

7-seater

Anchor point locations (where fitted)

The anchor points are located under a cover on the rear seatback (luggage compartment side).



WARNING

- Refer to the child restraint manufacturer's manual for proper installation of the child re-

straint's top tether on the rear seat. If in doubt, consult a NISSAN dealer or qualified workshop.

- Only the anchor points can be used for top tether strap anchorage.

CAUTION

If you have any questions when installing a top tether strap child restraint on the rear seat, consult a NISSAN dealer or qualified workshop for details.



NOTE

امداد خودرو فارما

تلفن شبانه روزی: ۰۲۱-۸۸۸۶۲۰۸۵

FarmaSOS.com

2 Instruments and controls

Meters and gauges	2-2	Rear fog light	2-27
Speedometer	2-2	Headlight aiming control	2-27
Fuel gauge	2-2	Headlight aiming control switch (where fitted)	2-27
Tachometer	2-2	Automatic aiming control (xenon headlights)	2-27
Engine coolant temperature gauge	2-2	Headlight cleaner (where fitted)	2-28
Warning/indicator lights and audible reminders	2-3	Hazard warning flasher switch	2-28
Checking bulbs	2-3	Horn	2-29
Warning lights	2-3	Seat heating (where fitted)	2-29
Indicator lights	2-7	Power outlet	2-30
Audible reminders	2-9	Storage	2-31
Vehicle information display	2-11	Storage trays	2-31
Warnings and alerts	2-12	Glove box	2-31
Odometer/twin trip odometer	2-16	Console box	2-32
Brightness control	2-16	Cup holders	2-32
Trip computer	2-16	Bottle holder	2-32
Settings menu	2-18	Map pocket (where fitted)	2-32
Cruise control/Speed limiter indicator (where fitted)	2-21	Seat pocket (where fitted)	2-32
Wiper and washer switch	2-21	Roof rail (where fitted)	2-32
Windscreen	2-22	Rear parcel shelf (where fitted)	2-33
Rear window	2-23	Tonneau cover (where fitted)	2-33
Defogger switch	2-23	Windows	2-34
Rear window defogger	2-23	Power windows	2-34
Outside mirror defogger (where fitted)	2-24	C-View® glass roof (where fitted)	2-36
Headlight and turn signal switch	2-24	Sunshade operation	2-36
Xenon headlights (where fitted)	2-24	System reinitialisation	2-37
Headlight switch	2-24	Interior lights	2-37
Turn signal switch	2-26	Front Room light	2-37
Fog light switch	2-26	Map lights (where fitted)	2-38
Front fog light (where fitted)	2-26	Rear room/reading light	2-38
		Luggage compartment light	2-38

Vanity mirror light (where fitted)..... 2-38

امداد خودرو فارما

تلفن شبانه روزی: ۰۸۵-۸۸۸۶۲۰۲۱

FarmaSOS.com

METERS AND GAUGES

NOTE

For an overview see “Instrument and control layout” in the “0. Illustrated table of contents” section and see “Meters and gauges” in the “0. Illustrated table of contents” section.

SPEEDOMETER

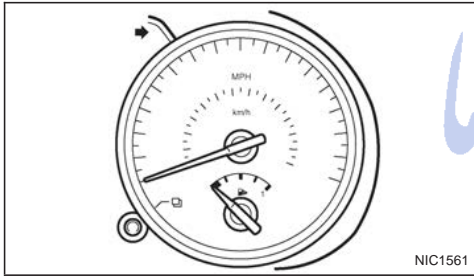

The speedometer indicates the vehicle speed (km/h or MPH). Scale resolution on the meter varies with models.

FUEL GAUGE

The fuel gauge is active when the ignition switch is in the ON position.

The gauge may move slightly during braking, turning, acceleration, or when going up- or downhill.

The  symbol indicates that the fuel filler lid is located on the right side of the vehicle.

NOTE

A low fuel warning comes on in the vehicle infor-

mation display and the Low fuel indicator light comes on in the combination meter when the fuel level is getting low. Refuel as soon as it is convenient. There should be a small reserve of fuel in the tank when the fuel gauge needle reaches the empty level.

CAUTION

Refill the fuel tank before the gauge registers empty.

TACHOMETER

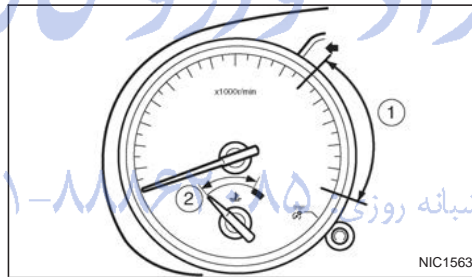

The tachometer indicates the engine speed in revolutions per minute (r/min). **Do not rev the engine into the red zone ①.**

Scale resolution on the meter varies with models.

CAUTION

When the engine speed approaches the red zone, shift to a higher gear. Operating the engine in the red zone may cause serious engine damage.

ENGINE COOLANT TEMPERATURE GAUGE

The gauge indicates the engine coolant temperature. The engine coolant temperature should remain within the normal range ②.

The engine coolant temperature varies with the outside air temperature and driving conditions.































CAUTION

If the gauge exceeds the normal range, stop as soon as safely possible. If the engine is overheated, continued operation of the vehicle may seriously damage the engine see “Engine overheat” in the “6. In case of emergency” section for immediate action.

WARNING

Allow the engine to cool down before removing the radiator cap to avoid the danger of being scalded.

WARNING/INDICATOR LIGHTS AND AUDIBLE REMINDERS

	Anti-lock Braking System (ABS) warning light (orange)		Seat belt (driver and front passenger) warning light (red)		Low fuel indicator light (orange)
	Brake warning light (red)		Supplemental Restraint System (SRS) air bag warning light (red)		Slip indicator light (orange)
	Charge warning light (red)		Water in fuel filter warning light (orange)		Front fog light indicator light (green)
	Diesel Particulate Filter (DPF) warning light (orange)		4WD warning light (orange)		Rear fog light indicator light (orange)
	Electronic Power Assisted Steering (EPAS) warning light (red)		Automatic Transmission check indicator light (AT models) (orange)		High beam indicator light (blue)
	Engine oil pressure/level warning light (red)		Continuously Variable Transmission (CVT) indicator light (orange)		Dipped beam indicator light (green)
	Front passenger air bag deactivated (OFF) warning light (red)		Electronic Stability Programme (ESP) OFF indicator light (orange)		Side light and headlight indicator light (green)
	Malfunction warning light (red) Malfunction Indicator light (orange)		4WD mode indicator light (AUTO) (green)		SPORT mode indicator light
	Master warning light (orange)		4WD mode indicator light (LOCK) (orange)		Trailer direction indicator light (green)
	NATS security warning light (red)		Glow plug indicator light (Diesel engine) (orange)		Turn signal/hazard indicator lights (green)

CHECKING BULBS

With all doors closed, apply the handbrake, fasten the seat belts and turn the ignition switch to the ON position without starting the engine. The following lights (where fitted) will come on:

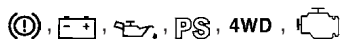

The following lights (where fitted) come on briefly and then go off:



If any light fails to come on, it may indicate a burned-out bulb or an open circuit in the electrical system. Have the system checked, and repaired promptly by a NISSAN dealer or qualified workshop.

WARNING LIGHTS

Also see "Vehicle information display" later in this section.

Anti-lock Braking System (ABS) warning light

After turning the ignition switch to the ON position, the light will illuminate. The anti-lock braking system warning light will turn off after approximately 2 seconds if the system is operational.

If the light comes on while the engine is running, it may indicate that the anti-lock portion of the braking system is not functioning properly. Have the system checked by a NISSAN dealer or qualified workshop.



Brake warning light

This light functions for both the handbrake and the footbrake systems.

Handbrake indicator:

The light comes on when the handbrake is applied.

Low brake fluid warning:

The light warns of a low brake fluid level. If the light comes on while the engine is running with the handbrake not applied, stop the vehicle and perform the following procedure:

1. Check the brake fluid level. Add brake fluid as necessary. See "Brake and clutch fluid" in the "8. Maintenance and do-it-yourself" section.



WARNING

If the level is below the MIN (minimum) mark on the brake fluid reservoir, do not drive until the brake system has been checked at a NISSAN dealer or qualified workshop.

2. If the brake fluid level is correct:

Have the warning system checked by a NISSAN dealer or qualified workshop.



WARNING

- Driving your vehicle could be dangerous. Have it towed to the nearest NISSAN dealer or qualified workshop.
- Depressing the brake pedal with the engine stopped could increase your stopping distance and require greater pedal travel distance and effort.



Charge warning light

If the light comes on while the engine is running, it may indicate that the charging system is not functioning properly. Turn the engine off and check the alternator belt. If the belt is loose, broken, missing or if the light remains on, see a NISSAN dealer or qualified workshop immediately.

CAUTION

Do not continue driving if the alternator belt is loose, broken or missing.



Diesel Particulate Filter (DPF) warning light (where fitted)



WARNING

- Be careful not to burn yourself with exhaust gases.
- Do not park the vehicle over flammable materials such as dry grass, waste paper or rags, as they may burn easily.

- If the vehicle continues to be driven at a low speed with the DPF warning light illuminated, the fail-safe will limit engine revolutions and/or torque. In this case, the engine oil must be replaced and the process of burning accumulated particulate matter must be carried out by a NISSAN dealer or qualified workshop. Service regeneration is a maintenance item and is not covered by the NISSAN warranty.
- Use engine oil for DPF equipped models. For details, see "Capacities and recommended fuel/lubricants" in the "9. Technical information" section.

CAUTION

The DPF becomes extremely hot after burning particulate matter.

M9R engine only:

When the ignition switch is turned to the ON position, the Diesel Particulate Filter (DPF) warning light illuminates for a few seconds and then goes out. This indicates that the system is operational.

All diesel engines:

NISSAN GREEN PROGRAM

Some diesel engine models are fitted with a Diesel Particulate Filter (DPF), which is a device that removes carbon (soot) from the exhaust gas. To operate effectively, the DPF system must routinely conduct a cleaning operation, called regeneration, that

2-4 Instruments and controls



burns-off the accumulated carbon. This regeneration process is normally automatic and not visible to the driver.

Regeneration restrictions:

Driving conditions such as frequent short journeys or stop/start driving can result in excessive build up of carbon in the filter. When this happens the DPF warning light will illuminate (and a message will appear in the vehicle information display, see "Vehicle information display" later in this section) to inform you that the vehicle must be driven in a particular manner to begin regeneration.

When the DPF warning light is illuminated, provided that legal and safety conditions allow, the vehicle should be driven at a speed of over 60 km/h (37.5 MPH) until the DPF warning light turns off. This process can take up to 30 minutes to complete.

If regeneration fails:

Failure to react to the DPF warning light may lead to saturation of the DPF system. If this happens the Malfunction Indicator (MI)  will illuminate indicating that a Service Regeneration by a NISSAN dealer or qualified workshop is required. The engine speed may also be limited to 3,000 rpm to protect the DPF system.

NOTE

Contact a NISSAN dealer or qualified workshop to perform a forced regeneration.

Electronic Power Assisted Steering (EPAS) warning light

When the ignition switch is turned to the ON position, the EPAS warning light illuminates. This means the system is operational.

If the warning light remains illuminated after the engine has been started, there will be no power steering assistance: the vehicle may be driven using the mechanical steering system although it is not recommended as the effort required to turn the steering wheel will be significantly increased compared to normal operation.



WARNING

- If the EPAS warning light illuminates while driving, stop as soon as safely possible.
- In certain circumstances, factors external to the EPAS system may contribute to the illumination of the warning light. If the warning light illuminates, stop the vehicle as soon as safely possible if driving, turn the ignition switch to the "OFF" position for approximately 20 seconds and then turn the ignition switch to the ON position again. If the light remains illuminated, we recommend that you contact a NISSAN dealer or qualified workshop.

See "Power steering system" in the "5. Starting and driving" section for further details on the EPAS system.



Engine oil pressure warning light

This light warns of low engine oil pressure. If the light flickers or comes on during normal driving, or stays on once the engine is started, pull off the road at a safe area, stop the engine **immediately** and call a NISSAN dealer or qualified workshop.

CAUTION

Running the engine with the engine oil pressure warning light on could cause serious damage to the engine.

NOTE

The [Oil level low] message indication is displayed for 5 seconds after the ignition switch has been turned to the ON position. See "Vehicle information display" later in this section.



Front passenger air bag deactivated (OFF) warning light

When the ignition switch is turned to the ON position the front passenger air bag deactivated (OFF) warning light , located in the combination meter, illuminates for approximately 7 seconds and then goes off. This means the system is operational.

The light warns of front passenger air bag status. If the front passenger air bag has been deactivated, the light comes on and stays on as long as the front passenger air bag switch remains in the OFF position.



Malfunction warning light (red) (where fitted)

When the ignition switch is turned to the ON position, the malfunction warning light illuminates. This means the system is operational.

See "Malfunction Indicator light" later in this section for details of the orange Malfunction Indicator light.

If the red malfunction warning light comes on steady while the engine is running, it may indicate an engine control system malfunction.

Have your vehicle inspected by a NISSAN dealer or qualified workshop. You do not need to have your vehicle towed to the dealer.

CAUTION

Continued vehicle operation without having the engine control system checked and repaired as necessary could lead to poor driveability, reduced fuel economy and possible damage to the engine control system, which may affect your warranty coverage.

Incorrect setting of the engine control system may lead to non-compliance of local and national emission laws and regulations.



Master warning light

The master warning light is displayed when any warning message is displayed. See "Vehicle information display" later in this section.



NATS security warning light (where fitted)

This light blinks whenever the ignition switch is in the LOCK, "OFF" or Acc position. This function indicates that your vehicle is equipped with the NISSAN Anti-Theft System (NATS)*.

If NATS is malfunctioning, this light will remain on while the ignition switch is in the ON position.

For additional information, see "Security system" later in this section.

* Immobilizer



Seat belt (driver and front passenger) warning light

The seat belt warning light alerts the driver if their seat belt or that of the front passenger is not securely fastened. The light will come on when the ignition switch is turned to the ON position. It will go out when both the driver and front passenger (if occupied) seat belts have been securely fastened.

A seat belt reminder chime is also fitted, see "Seat belt reminder chime" later in this section.



Supplemental Restraint System (SRS) air bag warning light

When the ignition switch is in the ON or START position, the Supplemental Restraint System (SRS) air bag warning light will illuminate. The SRS air bag warning light will turn off after approximately 7 seconds if the system is operational.

The air bag systems and pre-tensioner seat belts

need servicing and the vehicle must be taken to the nearest NISSAN dealer or qualified workshop if the SRS air bag warning light:

- Remains on after approximately 7 seconds
- Flashes intermittently
- Does not come on at all

Unless checked and repaired, the SRS air bag system and pre-tensioner seat belts may not function properly.

For additional details see "Air bag warning light" in the "1. Safety — seats, seat belts and supplemental restraint system" section.



4WD warning light (4WD models)

The 4WD warning light comes on when the ignition switch is turned to the ON position. It turns off soon after the engine is started.

If the 4WD system malfunctions or the revolution or radius of the front and the rear wheels differs, the warning light will either remain illuminated or blink. See "Four-wheel Drive (4WD) (where fitted)" in the "5. Starting and driving" section.

CAUTION

- **If the warning light comes on or blinks while driving, 4WD mode will change to 2WD mode. Reduce the vehicle speed and have your vehicle checked by a NISSAN dealer or qualified workshop as soon as possible.**



- Do not drive on dry, hard surfaced roads in the LOCK position.
- If the 4WD warning light blinks in the following sequence while driving, proceed as instructed:

- Blinks rapidly (about twice a second)

Pull off the road at a safe place and idle the engine. The driving mode will change to 2WD to prevent the 4WD system from malfunctioning. The vehicle can be driven again as soon as the warning light turns off.

- Blinks slowly (about once every 2 seconds)

Change the driving mode to 2WD and reduce the vehicle speed as soon as safely possible.

If the warning light is still on after performing the above operation, have the system checked by a NISSAN dealer or qualified workshop as soon as possible.



Water in fuel filter warning light (where fitted)

If the warning light remains on or flashes irregularly while the engine is running, there may be water in the fuel filter. Should this happen, try to drain the water from the fuel filter, see "Fuel filter (Diesel engine models)" in the "8. Maintenance and do-it-yourself" section.

CAUTION

Failure to drain the water from the fuel filter can cause serious damage to the engine. Contact a NISSAN dealer or qualified workshop as soon as possible.

INDICATOR LIGHTS

Automatic transmission check indicator light (AT models)

This light indicates both the "Automatic transmission oil temperature warning" and the "Fail-safe operation".

Automatic transmission oil temperature warning:

This light comes on when the automatic transmission oil temperature is too high. If the light comes on while driving, reduce the vehicle speed as soon as safely possible until the light turns off.

Fail-safe operation:

When the ignition switch is turned ON, the light comes on for 2 seconds. If the light blinks, it may indicate the automatic transmission is not functioning properly. Have your NISSAN dealer or qualified workshop check and repair the transmission.

CAUTION

Continued vehicle operation when the automatic transmission check warning light is on may damage the automatic transmission.



Continuously Variable Transmission (CVT) indicator light (CVT models)

This light comes on briefly when the ignition is turned to the ON position.

If the CVT light comes on during normal operation, it may indicate that something is wrong with the Continuously Variable Transmission (CVT). Have your system checked by a NISSAN dealer or qualified workshop.

NOTE

A CVT ELECTRONIC CONTROL SYSTEM WARNING display (centre console — where fitted) will come on when a malfunction may have occurred to the transmission control system. The selected Detailed Information key will then recommend going to a NISSAN dealer for the system to be checked.



Electronic Stability Program (ESP) OFF indicator light (where fitted)

The light comes on when the Electronic Stability Programme (ESP) OFF switch is pushed to the OFF position. This indicates that the ESP system is not operating.

This light also comes on briefly when the ignition switch is turned to the ON position. The light will turn off after approximately 1 second if the ESP system is operational.

When the ESP OFF indicator light and SLIP indicator light come on with the ESP system turned on, it alerts the driver to the fact that the system's fail-safe mode is operating. This means that the system may not be functioning properly. Have the system checked by your NISSAN dealer or qualified workshop.

If an abnormality occurs in the system, the ESP system function will be cancelled, but the vehicle is still driveable. For additional information, see "Electronic Stability Programme (ESP) system (where fitted)" in the "5. Starting and driving" section.

 **4WD mode indicator light (AUTO) (4WD models)**

This light comes on briefly when the ignition is turned to the ON position. If the engine is running, this light will illuminate when the 4WD AUTO mode is selected.

See "Four-wheel Drive (4WD) (where fitted)" in the "5. Starting and driving" section.

 **4WD mode indicator light (LOCK) (4WD models)**

This light comes on briefly when the ignition is turned to the ON position.

If the engine is running, this light and the 4WD mode indicator light (AUTO) will be lit when the 4WD LOCK mode is selected.

See "Four-wheel Drive (4WD) (where fitted)" in the "5. Starting and driving" section.



Glow plug indicator light (Diesel engines)

This light comes on when the ignition switch is in the ON position and goes out when the glow plugs have been pre-heated. When the engine is cold, the glow plug warm-up time will be longer.



Low fuel indicator light

When the fuel level is getting low, the low fuel warning light will switch on to alert the driver. Refuel as soon as it is convenient. There should be a small reserve of fuel in the tank when the fuel gauge reaches the empty level. See also "Vehicle information display" later in this section.



Malfunction Indicator light

When the ignition switch is turned to the ON position, the orange Malfunction Indicator light illuminates. This means that the system is operational.

If the orange Malfunction Indicator light comes on steady or blinks (where fitted) while the engine is running, it may indicate an engine control system malfunction.

See "Malfunction warning light (red) (where fitted)" earlier in this section for details of the red malfunction warning light (where fitted).

On steady (orange):

An engine malfunction has been detected. Have the vehicle inspected by a NISSAN dealer or qualified workshop. You do not need to have your vehicle towed to the dealer.

Blinking (orange) (where fitted):

An engine misfire has been detected which may damage the engine control system.

To reduce or avoid engine control system damage:

- Do not drive at speeds above 70 km/h (43 MPH).
- Avoid hard acceleration or deceleration.
- Avoid steep uphill grades.
- If possible, reduce the load being carried or towed.

The Malfunction Indicator light may stop blinking and come on steady.

Have the vehicle inspected by a NISSAN dealer or qualified workshop. You do not need to have your vehicle towed to the dealer.

CAUTION

Continued vehicle operation without having the engine control system checked and repaired as necessary could lead to poor driveability, reduced fuel economy and possible damage to the engine control system, which may affect your warranty coverage.





SLIP indicator light (where fitted)

The SLIP indicator blinks when the Electronic Stability Programme (ESP) system is operating, thus alerting the driver to the fact that the road surface is slippery and the vehicle is nearing its traction limits.

You may feel or hear the system working, this is normal.

The light will continue to blink for a few seconds after the ESP system stops limiting wheel spin.



Front fog light indicator light (where fitted)

The light comes on when the front fog lights are switched on.



Rear fog light indicator light

The light comes on when the rear fog light is switched on.



High beam indicator light

This light comes on when the headlight high beam is on and goes out when the low beam is selected.



Dipped beam indicator light

This light comes on when the switch is turned to the position:  The headlights will come on and front side, tail, number plate and instrument lights remain on.



Side light and headlight indicator light

This light comes on when the side light or headlight position is selected. See "Headlight and turn signal switch" later in this section for further details.



SPORT mode indicator light (where fitted)

The SPORT mode indicator light illuminates when the SPORT mode is turned ON. See "SPORT mode switch" in the "5. Starting and driving" section for the use of the SPORT mode switch.



Trailer direction indicator light

The light will light up whenever an additional electrical load is detected by the direction indicator system.

For additional information, see "Trailer towing" in the "5. Starting and driving" section.



Turn signal/hazard indicator lights

The direction indicator lights will flash when the turn signal switch or hazard warning flasher switch is turned on. See "Headlight and turn signal switch" later in this section and see "Hazard warning flasher switch" later in this section for further details.

AUDIBLE REMINDERS

Door open reminder chime

The chime will sound if any door other than the driver's door is left open and the power door lock switch is held down.

Intelligent Key models: The external buzzer will sound if the vehicle is being locked remotely or using an outside door lock switch and any door is open.

Handbrake reminder buzzer

A buzzer will sound when driving away if the handbrake has not been released.

Light reminder chime

A chime will sound for 10 seconds if the driver's door is opened while the external lights are turned on and the ignition switch is in the "OFF" or LOCK position.

See "Headlight and turn signal switch" later in this section for further details on the headlight operation.

Fog light reminder chime

A chime will sound if the ignition switch is in the "OFF" or LOCK position and the headlight switch is in the AUTO position (where fitted) and the fog lights are left on.

See "Headlight and turn signal switch" later in this section for further details.

Seat belt reminder chime

A chime will sound for approximately 90 seconds if the vehicle's speed exceeds 15 km/h (9 MPH) and the driver's seat belt or front passenger's seat belt, if occupied is not securely fastened. See "Ignition knob warning (Intelligent Key models)" later in this section.

Key reminder buzzer (Intelligent Key models)

The external buzzer will beep 3 times if:

- The Intelligent Key is removed from the vehicle while the ignition is not in the LOCK position.
- The vehicle is being locked remotely or using an outside door lock switch and the Intelligent Key has been left inside the vehicle.

Park reminder chime (AT or CVT models)

A chime will sound if the ignition switch is turned to LOCK and the gear selector lever is not in the P (Park) position.

امداد خودرو فارما

تلفن شبانه روزی: ۰۲۱-۸۸۸۶۲۰۸۵

FarmaSOS.com



VEHICLE INFORMATION DISPLAY

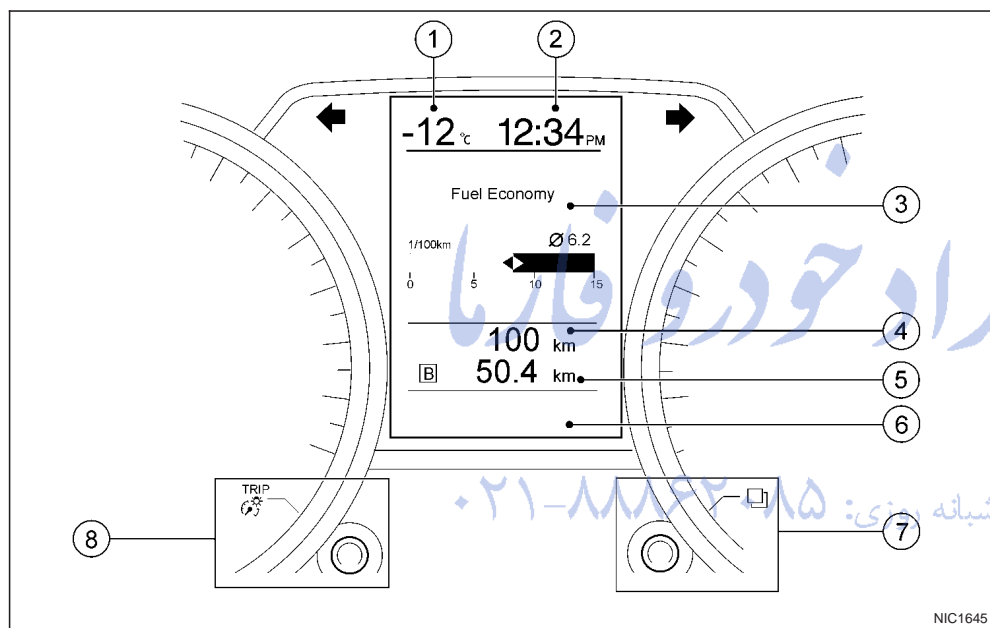

- ⑥ Gear shift indicator (where fitted), see (P. 5-16)
Stop/Start system indicator (where fitted), see (P. 5-21)
- ⑦ switch/shaft (Settings control and trip computer control)
- ⑧ switch/shaft (Twin trip odometer control and brightness level control)

WARNING

- Operating the vehicle information display while driving can lead to a crash resulting in serious injuries or death. Always park the vehicle in a safe place before operating the display screen.
- Look at the display screen only briefly while driving. Keep your eyes on the road. Inattentive driving may lead to a crash resulting in serious injuries or death.

- ① Outside temperature (P. 2-19)
- ② Clock (P. 2-19)
- ③ Warnings and alerts (P. 2-12)
Trip computer (P. 2-16)
Engine oil level information (P. 2-15)
Cruise control (P. 5-29)
- Speed limiter (P. 5-31)
- Settings menu (P. 2-18)
- Intelligent Key operation (P. 2-6)
- ④ Odometer (P. 2-16)
- ⑤ Twin trip odometer (P. 2-16)

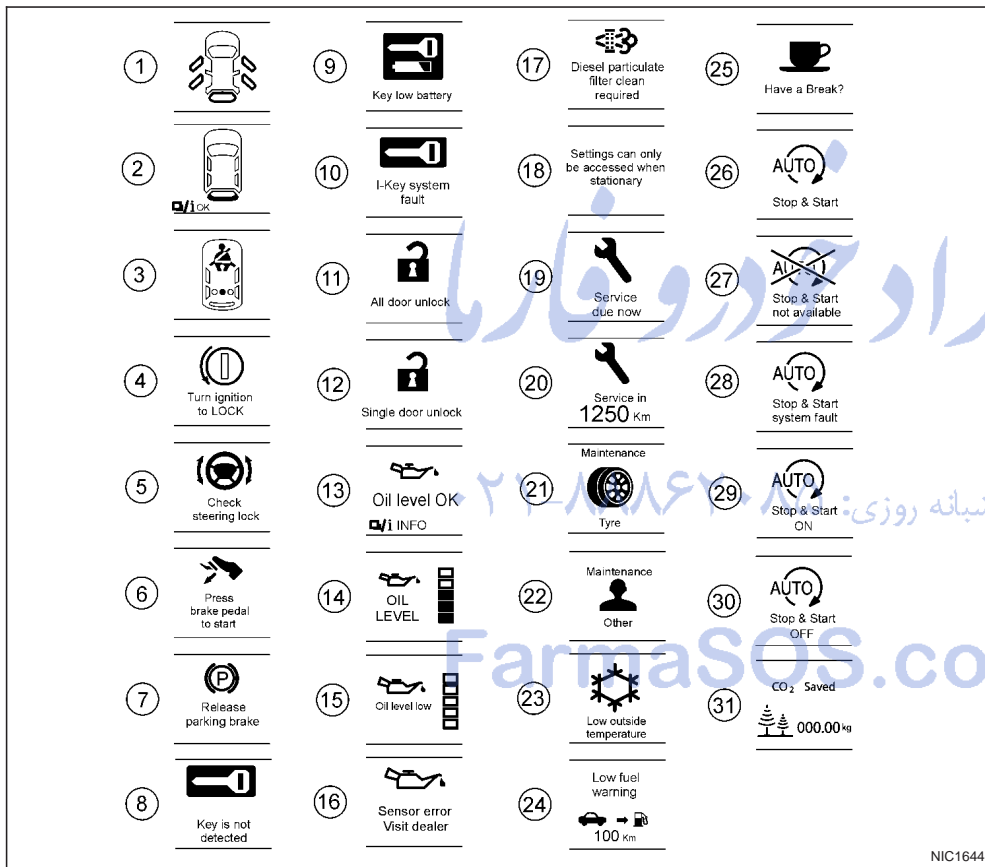

NIC1644

WARNINGS AND ALERTS

The design of the warnings and alerts may differ depending on the model.

① Door open warning

This warning appears if any of the doors are open or not closed securely. The vehicle icon indicates which door is open on the display.

② Back door open warning

This warning appears if the back door is open or not closed securely. When the door is to be left open, e.g. when you transport a long load, push the switch or the steering wheel switch (where fitted) to confirm.

③ Seat belt warning (Rear seat or 2nd row)

The seat belt warning indicates the seating position when the ignition switch is turned to the ON position and disappears when:

- All related seat belts have been securely fastened.
- The switch or the steering wheel switch (where fitted) is pushed.
- Approximately 35 seconds after engine start.

WARNING

Seat belts for 3rd row seats (where fitted) are not part of the seat belt warning light monitoring system.



For more information, see "Seat belts" in the "1. Safety — seats, seat belts and supplemental restraint system" section

④ Ignition knob warning (Intelligent Key models)

The warning appears when the ignition knob is left in the Acc or "OFF" position instead of completely being turned to the LOCK position.

If this warning appears, turn the ignition knob to the LOCK position.

When the ignition knob is in the ON position, a buzzer will sound twice and the ignition knob warning shows when the ignition knob is turned to the Acc or "OFF" position. This is to warn the driver that the ignition knob is not in the LOCK position.

MT models:

Depress the ignition PUSH release button and turn the ignition knob to the LOCK position.

AT or CVT models:

Make sure the gear selector lever is in the P (Park) position and then turn the ignition switch to the LOCK position.

See "Ignition knob (where fitted)" in the "5. Starting and driving" section for further details.

CAUTION

- **The steering wheel can only be locked when the ignition knob is in the LOCK position. Make sure the ignition knob is in the LOCK position before leaving the vehicle.**

- **The emergency key can only be removed at the LOCK position. Make sure the ignition knob is in the LOCK position before removing the emergency key.**

See "Steering lock" in the "5. Starting and driving" section for further details.

⑤ Steering wheel lock warning

The warning appears when the ignition knob is pressed, but not turned to the Acc or "OFF" position within a short period. Move the steering wheel to release the lock and turn the ignition knob to Acc or ON. The warning will turn off in approximately 5 seconds.

See "Steering lock" in the "5. Starting and driving" section for further details.

⑥ Brake/Clutch warning (where fitted)

When starting your vehicle, it is necessary to operate the brake (CVT and AT models) or clutch pedal (MT models).

For more information, see "Starting the engine" in the "5. Starting and driving" section.

⑦ Handbrake reminder

The reminder will come on if the handbrake is on whilst the vehicle is being driven.

A buzzer will also sound.

⑧ Intelligent Key detection warning

If the Intelligent Key is taken outside of the vehicle ID recognition zone while the ignition knob is in the Acc or ON position, the Intelligent Key detection warning will be displayed and a buzzer will sound. The Intelligent Key detection warning disappears when the Intelligent Key is placed back in the passenger compartment.

The message also appears when you try to start the vehicle if the Intelligent Key is not detected within the vehicle.

For more information, see "Integrated keyfob/remote control system" in the "3. Pre-driving checks and adjustments" section.

⑨ Intelligent Key low battery warning

The Intelligent Key low battery warning may show if a low battery voltage is detected when the ignition knob is turned from "OFF" to the ON position.

For more information, see "Integrated keyfob/Intelligent Key battery replacement" in the "8. Maintenance and do-it-yourself" section.

⑩ Intelligent Key system fault warning

CAUTION

If the Intelligent Key system fault warning comes on, it may indicate a system malfunction. We recommend that you contact a NISSAN dealer or qualified workshop for repair.

For more information, see "Integrated keyfob/remote control system" in the "3. Pre-driving checks and adjustments" section.

⑪ Intelligent Key convenience mode alert



The Intelligent Key convenience mode alert shows to confirm that convenience mode has been activated. See "Switching from Convenience mode to Anti-hijack mode" in the "3. Pre-driving checks and adjustments" section.

⑫ Intelligent Key anti-hijack alert

The Intelligent Key anti-hijack alert shows to confirm that anti-hijack mode has been activated. See "Switching from Convenience mode to Anti-hijack mode" in the "3. Pre-driving checks and adjustments" section.

⑬ Engine oil level information

When turning the ignition to the ON position, the oil message indicates the oil level.

The [Oil level OK] message indicates the oil level is sufficient for driving. Push the  switch or the steering wheel switch  (where fitted) when the [Oil level OK] message shows to see a more detailed oil level. (See Oil level [⑭](#))

NOTE

The [Oil level OK] message indication is displayed after the ignition switch has been turned to the ON position and other warnings have been shown.

CAUTION

The engine oil level check is not designed to indicate a low oil level. Use the dipstick to check the oil level.

See "Engine oil" in the "8. Maintenance and do-it-yourself" section.

⑭ Engine oil level

This display provides a visual representation of the engine oil level.

⑮ Engine oil level low

If the oil level is not sufficient for driving, the [Oil level low] message appears. Oil needs to be added before driving.

CAUTION

The engine oil level should be checked regularly. Operating with an insufficient amount of oil can damage the engine and such damage is not covered by the warranty.

Park the vehicle at a safe location as soon as possible and fill the engine with the recommended engine oil.

For checking the engine oil level and adding oil, see "Engine oil" in the "8. Maintenance and do-it-yourself" section.

⑯ Engine oil sensor warning

Please visit your local NISSAN dealer or qualified workshop if this warning appears.



⑰ Diesel Particulate Filter warning (where fitted)

See "Diesel Particulate Filter (DPF) (where fitted)" in the "5. Starting and driving" section for further details.

⑱ Setting menu operation alert

The alert shows when you try to operate the setting menu while driving. The setting menu can only be entered if the vehicle is stationary.

⑲ Maintenance due alert (where fitted)

This alert shows that maintenance is due. The message is shown until the steering wheel switch  (where fitted) is pressed. When the maintenance due alert reaches 0 km (miles), the  symbol flashes next to the odometer value.

CAUTION

The engine oil must be changed before the maintenance due alert is shown.

- Failure to do so risks causing damage to the engine.
- Continued driving after maintenance due alert reaches 0 km (miles) may result in reduced engine performance. The engine malfunction indicator light (orange) will illuminate.
- The DPF (where fitted) may also become saturated because regeneration is restricted once the distance equals 0 km (miles)

Always visit a NISSAN dealer or qualified workshop to perform the maintenance and the reset.

However reset is possible (only after the oil was changed) using the [Service] menu item in the [Settings] menu. See “[Maintenance]” later in this section

Have the vehicle inspected by a NISSAN dealer or qualified workshop if these conditions occur.

⑳ Distance to maintenance alert (where fitted)

This alert reminds when maintenance is due in the shown distance. The alert is shown for 10 seconds at ignition ON, when the distance to the next maintenance interval is below 5000 km (3100 Miles). The message is shown until the steering wheel switch ⓘ (where fitted) is pressed.

NOTE

- Visit a NISSAN dealer or qualified workshop before the maintenance due alert ⑲ reaches 0 km (miles) to perform maintenance (oil change).
- The maintenance interval will reduce faster with certain types of driving, especially at low speeds in urban conditions.

㉑ Tyre change alert

You can set a distance for changing tyres. See “[Maintenance]” later in this section

㉒ Maintenance alert

You can set a distance for a non specific maintenance item. See “[Maintenance]” later in this section

㉓ Low temperature warning

If, during driving, the temperature falls below 4°C this alert will appear to indicate low outside air temperature. You can switch the low temperature warning [On] or [Off]. See “[Units]” later in this section

CAUTION

Even if the alert is not on, there is no guarantee that the road is free of hazards caused by inclement weather.

NOTE

The outside air temperature sensor is located at the front of the vehicle. At low speeds the sensor can be affected by engine heat, heat reflected from the road surface and exhaust from other vehicles, these influences can cause the display to be inaccurate. To compensate, the outside air temperature display is designed to react slowly to increasing temperatures, but quickly to falling temperatures.

㉔ Low fuel warning

This warning appears when the fuel level in the tank is getting low. Refuel as soon as it is convenient, preferably before the fuel gauge reaches the empty position. For more information, see “Fuel gauge” earlier in this section.

㉕ Driver alert

This warning appears when the previously set time for a break is reached. You can set the time for up to 6 hours in the setting menu. (See “Settings menu” later in this section.)

Stop/Start System (where fitted)

For more information, see “Stop/Start System (where fitted)” in the “5. Starting and driving” section

㉖ Engine stop:

If the engine stops when the Stop/Start System is activated, the message is shown.

㉗ Auto start deactivation:

If the engine stops when the Stop/Start System is activated, and will not start automatically, the message is shown.

㉘ System fault:

If the Stop/Start System is activated, but does not operate correctly, the message is shown. Visit a NISSAN dealer or qualified workshop.

Activating or deactivating using the Stop/Start System OFF switch:

Using the Stop/Start System OFF switch activates or deactivates the Stop/Start System. This is shown in the vehicle information display:

㉙: The Stop/Start System OFF switch is pushed to the “ON” position.

㉚: The Stop/Start System OFF switch is pushed to the “OFF” position.

ODOMETER/TWIN TRIP ODOMETER

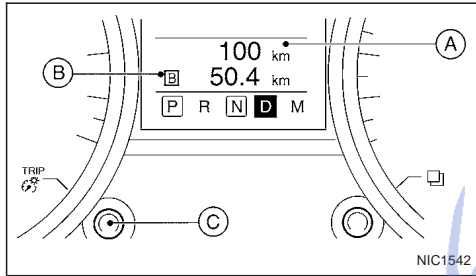

The odometer and twin trip odometer are displayed when the ignition switch is in the ON position.

Odometer

The odometer (A) records the total distance the vehicle has been driven.

Twin trip odometer

The twin trip odometer (B) records the distance of 2 individual trips (Trip A and Trip B).

Changing the display:

Briefly press the TRIP switch (C) to change the display as follows.

Trip A → Trip B → Trip A

Resetting the trip odometer:

Press and hold the TRIP switch for approximately 1 second to reset the selected trip (Trip A or Trip B).

BRIGHTNESS CONTROL

Rotate the TRIP switch (C) anticlockwise to brighten or clockwise to dim the instrument lighting level.

NOTE

Brightness cannot be set when the headlight switch is in the OFF position.

TRIP COMPUTER

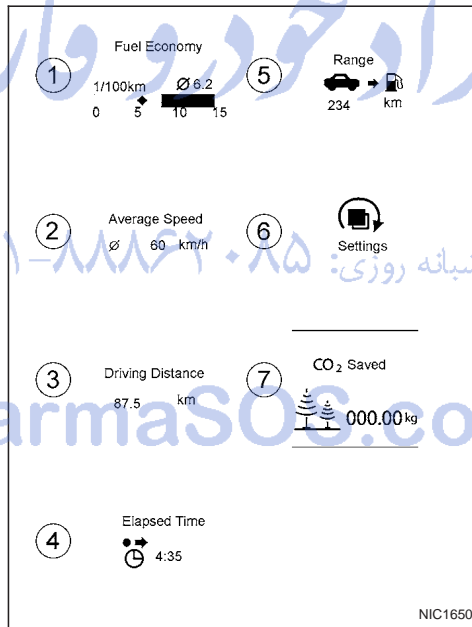

The trip computer is controlled using the switch or the steering wheel switch (1) (where fitted).

The trip computer contains the following items:

[Fuel Economy] → [Average speed] → [Driving distance] → [Elapsed time] → [Range] (km or MILES) → [Settings] → [CO2 Saved] (where fitted) → [Fuel Economy]

- Short press to change the information that is being displayed.
- Push and hold (up until 3 seconds) resets the current item that is displayed (except [Settings] and [Range]).
- Push and hold over 3 seconds performs a global reset. This resets all functions of the display (except [Range] and Trip A).

① Fuel Economy (l (litre)/100 km or MPG)

The [Fuel Economy] mode shows the current fuel consumption in a moving bar graph.

The average fuel consumption mode displays the average fuel consumption since the last reset.

It is shown in 2 ways:

- The Ø symbol (average) with the value on the top right of the bar.
- By the position of the ♦ icon (diamond) inside the bar.

② Average speed

The [Average speed] mode shows the average vehicle speed since the last reset.

③ Driving distance

The [Driving distance] mode shows the distance driven since the last reset.

④ Elapsed time

The [Elapsed Time] mode shows the time since the last reset.

⑤ Range (km or MILES)

The [Range] mode provides you with an estimation of the distance that can be driven before refuelling (distance to empty). The range is constantly being calculated, based on the amount of fuel in the fuel tank and the actual fuel consumption.

When the fuel level gets close to empty, the range will change to "----".

- If the amount of fuel added is small, the display just before the ignition switch is turned to the "OFF" position may continue to be displayed.
- When driving uphill or corners, the fuel in the tank shifts, this may momentarily change the display.

⑥ Settings

The [Settings] item is only displayed when using the  switch to control the trip computer.

Rotate the  switch to enter the [Settings] menu

For more information, see "Settings menu" later in this section.

⑦ CO2 saved (where fitted)

Estimated quantity of CO2 exhaust emissions prevented by Stop/Start System shown every time the engine is automatically stopped.

For more information, see "Stop/Start System (where fitted)" in the "5. Starting and driving" section

امداد خودرو فارما

تلفن شبانه روزی: ۰۲۱-۸۸۶۲۰۸۵

FarmaSOS.com

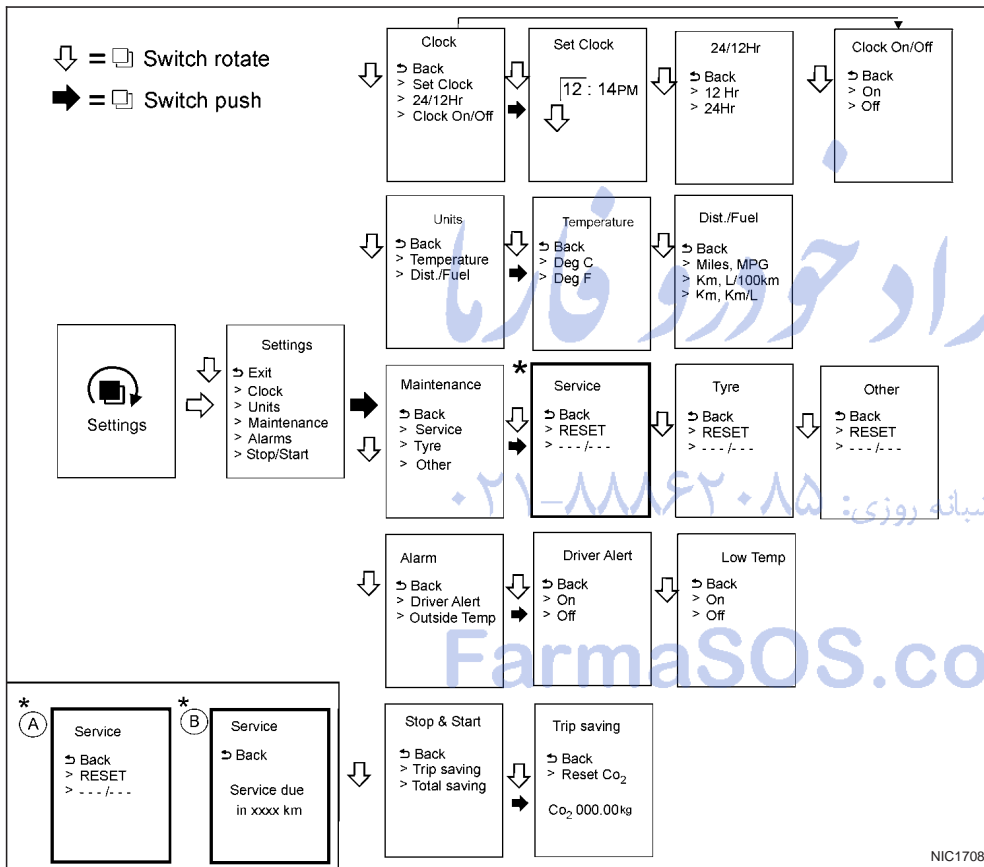

(A) Petrol models

(B) Diesel models

SETTINGS MENU

Select the [Settings] menu in the trip computer then rotate the □ switch to enter the Settings menu. Use the □ switch to select and set the items.

NOTE

Settings cannot be changed while driving.

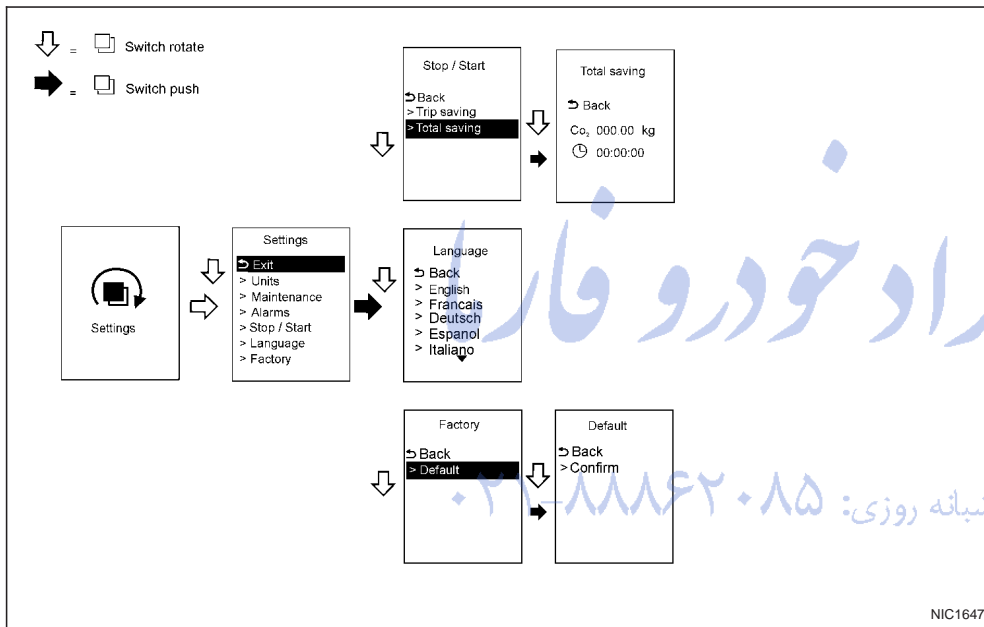

[Clock]

Clock adjustment can be set to:

- [Set Clock]

Adjust the time (hour and minute) of the clock on the meter by rotating the switch.

Push the switch to set the values

- [On] or [Off]

Select this submenu to set the clock display On or Off.

- [24/12 Hr]

Select this submenu to set the 12h/24h time display mode.

To return to the previous screen of the setting mode, select [Back].

[Units]

The following items can be set to your preference.

- [Temperature]

Select this submenu to choose from degrees Celsius (C) or Fahrenheit (F) on the display.

- [Dist./Fuel]

The fuel consumption units can be set too.

Select this submenu to choose:

- distance in miles, fuel consumption in MPG
- distance in km, fuel consumption in km/l
- distance in km, fuel consumption in l/100km

To return to the previous screen of the setting mode, select [Back].

[Alarms]

Alerts can be set to notify the following items.

- [Driver Alert]

Select this submenu to set the [Driver Alert] period.

- [Outside temp]

Select this submenu to set the low temperature alert [On] or [Off].

To return to the top page of the setting mode, select [Back].

[Stop/Start] (where fitted)

The CO2 savings and the engine stop time using the Stop/Start System are kept in a submenu.

- [Trip Saving]

View the estimated CO2 exhaust emissions prevented since last reset.

It is possible to reset using the [Reset CO2] submenu then push the switch to set to zero.

NOTE

The [Trip Saving] value is the same information that is displayed when the engine is automatically stopped by the Stop/Start System.

- [Total Saving]

View:

- The estimated CO2 exhaust emissions prevented.
- The time that the engine has been stopped by the Stop/Start System.

NOTE

The [Total Saving] values cannot be reset and show accumulated Stop/Start System information since the vehicle was built.

For more information, see “Stop/Start System (where fitted)” in the “5. Starting and driving” section.

[Maintenance]

The maintenance intervals of the following reminders can be set or reset:

- [Service] for engine oil change service reminder

Select this submenu to view, or reset the distance driven information or to set an interval (petrol models).

- **View the distance driven information:**

Select [Service].

- **Set procedure (petrol models only (A)):**

- 1) Select [Service].
- 2) Select the distance driven/interval information.
- 3) Turn the switch and set the interval (mileage) accordingly. For interval (mileage) details, see the separately provided Warranty Information and Maintenance booklet.
- 4) Short press the switch to confirm the set interval (mileage).

- **Reset procedure after changing engine oil.**
CAUTION

Do not perform the reset operation unless the engine oil has been changed.

For Petrol models (A):

- 1) Select [Service].
- 2) Select [Reset].

- 3) Select [Confirm] to confirm the reset of the distance driven information to zero.

For Diesel models (B):

- 1) Select [Service].
- 2) Press the switch for more than 2 seconds, then release.
- 3) Select [Reset].
- 4) Select [Confirm] to confirm the reset procedure.

Alternatively while the oil service message is displayed (where fitted):

After changing the engine oil: Turn the ignition switch to ON and, while the oil service message is displayed within 3 seconds, push both the and switches at the same time for more than 5 seconds.

The display goes blank for 1 second; the default interval is then displayed; and finally the display returns to normal.

- [Tyre]

Select this submenu to set or reset the distance for replacing tyres.

- [Other]

Select this submenu and set or reset the distance for replacing or checking other items.

To return to the previous page of the setting mode, select [Back].



For more information, contact your NISSAN dealer or qualified workshop.

[Language]

Select the submenu to set the desired language of the display

[Factory]

Select the submenu to reset the factory settings of the display.

NOTE

When resetting [Factory], all previous settings made are changed to default.

CRUISE CONTROL/SPEED LIMITER INDICATOR (where fitted)

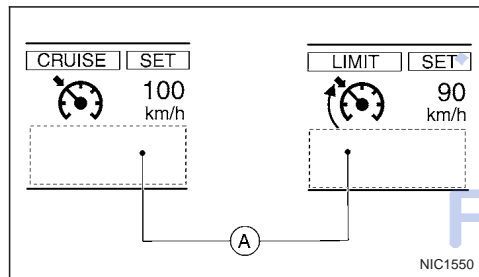

- The CRUISE indicator is displayed when the cruise control main "ON/OFF" switch is pushed. When the main switch is pushed again, the

CRUISE indicator disappears. When the CRUISE indicator is displayed, the cruise control system is operational.

The cruise control SET indicator is displayed while the vehicle speed is controlled by the cruise control system. If the SET indicator blinks while the engine is running, it may indicate that the cruise control system is not functioning properly. Have the system checked by an NISSAN dealer or qualified workshop.

For more details, see "Cruise control (where fitted)" in the "5. Starting and driving" section.

- The LIMIT indicator is displayed when the speed limiter main "ON/OFF" switch is pushed. When the main switch is pushed again, the LIMIT indicator disappears.

When the LIMIT indicator is displayed, the speed limiter is operational. The speed limiter is active, when the SET indicator is displayed.

For more details, see "Speed limiter" in the "5. Starting and driving" section.

When the trip computer was set before using the cruise control or speed limiter function, the trip computer menu item (A) is shown together with the cruise control or speed limiter. See "Trip computer" earlier in this section

WIPER AND WASHER SWITCH

WARNING

In freezing temperatures the washer fluid may freeze on the windscreen and obscure your vision. Warm the windscreen with the defroster before you wash it.

CAUTION

- Do not open/release the bonnet when the front wiper arms are raised from their original position.
- Do not operate the washer continuously for more than 15 seconds.
- Do not operate the washer if the reservoir tank is empty or frozen.

WINDSCREEN

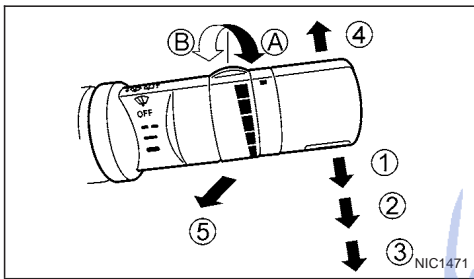

Intermittent (without rain sensor)

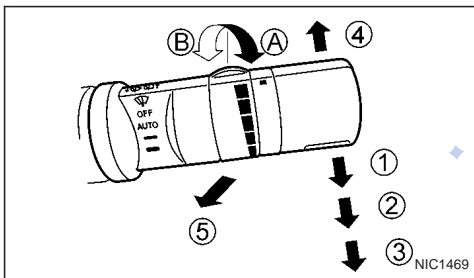

AUTO (with rain sensor)

The windscreen wiper and washer can be operated when the ignition switch is in the ON position.

Wiper operation

Move the lever up or down to operate the wiper at the following speeds:

Lever position **Up** (4) — for a single sweep operation of the wiper.

Lever position (1): **Intermittent** (■) or **AUTO**. **AUTO** (where fitted) operates the rain-sensing auto wiper system. (See "Rain sensor (where fitted)" later in this section.)

— The intermittent operation speed can be adjusted by rotating the ring forward (A) (slower) or backward (B) (faster).

— The wiper operation speed will vary (where fitted) in accordance with the vehicle speed. For example, when the vehicle speed is high, the intermittent operation speed will be faster.

Lever position **Low** (■) (2) — for continuous low speed operation

Lever position **High** (■) (3) — for continuous high speed operation

Washer operation

Pull the lever toward you (5) to operate the washer. For every fifth operation of the wiper and washer, the headlight washing system (where fitted) will be activated to clean the headlights. The headlight washing system is only activated while the headlight switch is in the (D) position. See "Headlight cleaner (where fitted)" later in this section.

Wiper drip wipe system (where fitted):

The wiper will also operate once about 3 seconds after the washer and wiper are operated. This operation is to wipe washer fluid that has dripped on the windscreen.

Rain sensor (where fitted)

The rain sensor is activated when the AUTO position (1) of the wiper switch is selected.

The wiper will start to operate automatically at a suitable speed when rain is detected on the windscreen.

The sensitivity of the rain sensing system can be adjusted by rotating the ring of the wiper switch forward (A) — less sensitive, or backward (B) — more sensitive.

NOTE

The rain sensor is only intended for use during rain or precipitation. During other weather conditions no harm will come to the rain sensor system if left active (wiper switch set to AUTO), although occasional unexpected activation of the wipers may occur.



REAR WINDOW

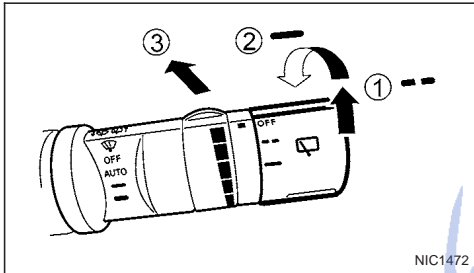



WARNING

In freezing temperatures the washer solution may freeze on the rear window and obscure your vision. Warm the rear window with the rear window defogger before you wash the rear window.

CAUTION

- Do not operate the washer continuously for more than 15 seconds.
- Do not operate the washer if the reservoir tank is empty or frozen.

The rear window wiper and washer can be operated when the ignition switch is in the ON position.

Turn the switch clockwise to the intermittent (, ①) position or continuous (, ②) position to operate the wiper.

To operate the rear window washer, push the switch towards the front of the vehicle ③. The rear window wiper will also operate.

NOTE

When the windscreen wiper switch is in either the intermittent or AUTO (where fitted), low or high speed position and the vehicle's gear lever is set in Reverse, the rear window wiper comes on (where fitted).

Wiper drip wipe system (where fitted)

The wiper will also operate once about 3 seconds after the washer and wiper are operated. This operation is to wipe washer fluid that has dripped on the windscreen.

DEFOGGER SWITCH

REAR WINDOW DEFOGGER

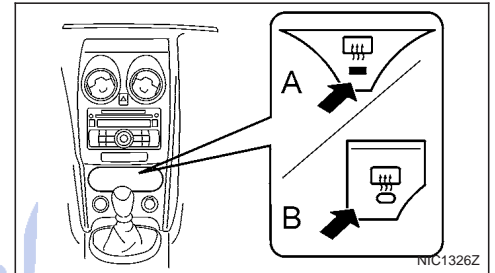

To defog/defrost the rear window glass, start the engine and push the (Type A or Type B) switch in. The indicator light will come on. Push the switch again to turn the defogger off.

The defogger will turn off automatically after approximately 15 minutes — if the rear window clears before this time, push the switch again to turn the defogger off.

CAUTION

When cleaning the inner side of the rear window, be careful not to scratch or damage the electrical conductors.

NOTE

When the air conditioner, or rear defogger is turned on the Stop/Start System will not be activated (For models with the Stop/Start System).

HEADLIGHT AND TURN SIGNAL SWITCH

OUTSIDE MIRROR DEFOGGER (where fitted)

The outside rear-view mirrors will be defogged when the defogger switch is activated.

XENON HEADLIGHTS (where fitted)



WARNING



HIGH VOLTAGE

- When xenon headlights are on, they produce a high voltage. To prevent an electric shock, never attempt to modify or disassemble. Always have your xenon headlights replaced at an authorised NISSAN dealer or qualified workshop.
- Xenon headlights provide considerably more light than conventional headlights. If they are not correctly aimed, they might temporarily blind an oncoming driver or the driver ahead of you and cause a serious accident. If headlights are not aimed correctly, immediately take your vehicle to a NISSAN dealer or qualified workshop and have the headlights adjusted correctly.

When the xenon headlight is initially turned on, its brightness or colour varies slightly. However, the colour and brightness will soon stabilise.

- The life of xenon headlights will be shortened by frequent on-off operation. It is generally desirable not to turn off the headlights for short intervals (for example, when the vehicle stops at a traffic signal).
- If the xenon headlight bulb is close to burning out, the brightness will drastically decrease, the light will start blinking, or the colour of the light

will become reddish. If one or more of the above signs occur, contact a NISSAN dealer or qualified workshop.

NISSAN recommends you to consult the local regulations concerning the use of lights.

HEADLIGHT SWITCH

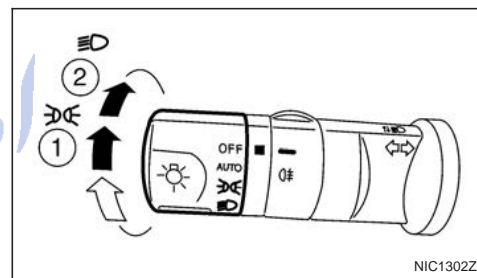

Lighting

Turn the switch to the  position:

- ① The front side, tail, number plate and instrument lights will come on. The indicator light

 in the instrument panel will come on.

Turn the switch to the  position:

- ② The headlights will come on and all the other lights remain on.

CAUTION

Never leave the light switch on for extended periods of time while the engine is not running.

Daytime light system (where fitted)

Even if the headlight switch is off, the headlight low beam, front side, rear combination and number plate lights will come on after starting the engine. However, you cannot change low beam to high beam when the light switch is off.

When the light switch is turned to the OFF position, the headlight low beam will turn off.

Autolight system (AUTO – where fitted)

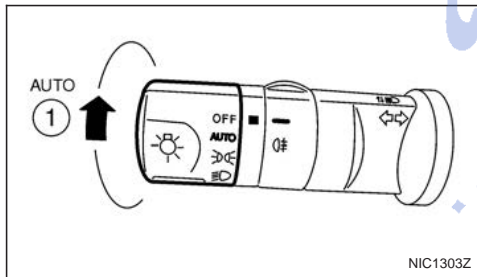

The autolight system allows the headlights to be set so they turn on and off automatically. When active, the autolight system will:

- Turn on the headlights, front side, tail, number plate and instrument panel lights automatically when it gets dark.
- Turn off all the lights when it gets light.

To activate the autolight system:

1. Turn the headlight switch to the AUTO position (1).
2. Turn the ignition switch to ON.

To disable the autolight system:

Turn the switch to the OFF, OFF or OFF position.

Headlight beam select

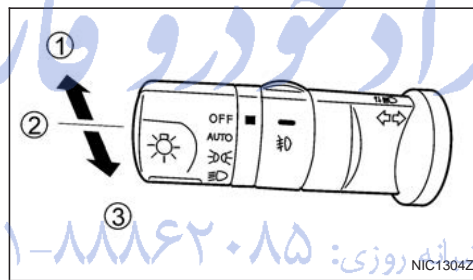

- 1 To select the high beam when in the OFF position, push the lever forward. The high beam lights come on and the indicator light illuminates.
- 2 Pull the lever back to select the low beam (OFF position).
- 3 Pulling the lever towards you will flash the headlight high beam, even when the headlight switch is off.

“Friendly Lighting”

The “Friendly Lighting” function is a convenience facility. It allows you to provide lighting from the vehicle after the ignition switch has been turned to the LOCK position and the headlight switch is in the OFF or AUTO (where fitted) position. Pulling the headlight switch toward you once will activate the headlight for approximately 30 seconds. After that period of time, it will automatically switch off.

It is possible to pull the headlight switch up to four times to increase the lighting period up to 2 minutes.

NOTE

The “Friendly Lighting” function can be cancelled by switching the ignition switch to the Acc or ON position again.

Battery save function

The battery save feature prevents your vehicle from discharging the battery after you have left the external lights, map lamps or room lamps on when exiting the vehicle. This occurs when the ignition switch or ignition knob is in the “OFF” or LOCK position.

NOTE

The next time the engine is started the external lights, map lamps or room lamp will come on again

Battery save function for external lights:

If the ignition switch is turned to the "OFF" position but the external lights are accidentally left on, the external lights will automatically be switched off as soon as the driver's door is opened.

It is possible to leave the external lights on permanently by switching them back on using the headlight switch while the ignition switch is still in the LOCK or "OFF" position. In this case, the light reminder chime will sound when the driver's door is opened.

Battery save function for interior light:

The interior light will automatically be switched off after approximately 15 minutes if it has been accidentally left on.

TURN SIGNAL SWITCH

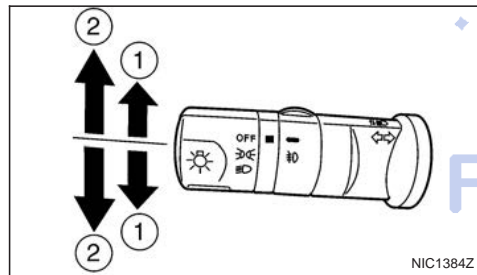

Lane change signal

Move the lever only part of the way up or down ① to signal a lane change (right or left). The indicator lights will flash three times before cancelling automatically.

Direction indicator

Move the lever up or down ② to indicate right or left. When the turn is completed, the turn signal is automatically cancelled.

FOG LIGHT SWITCH

FRONT FOG LIGHT (where fitted)

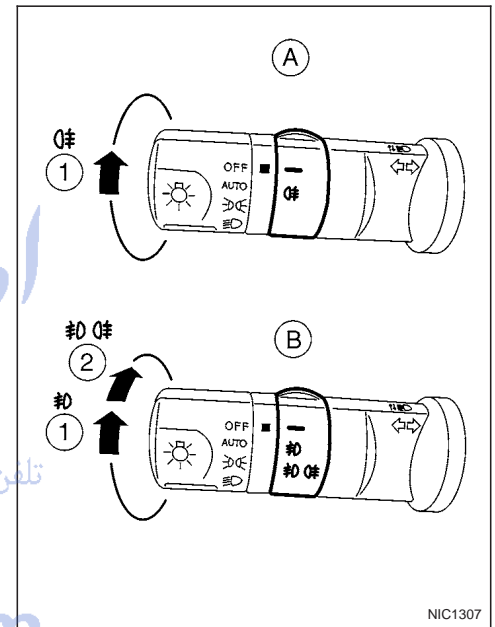

(A) Type A

(B) Type B

The front fog lights should only be used when visibility is seriously reduced – generally, to less than 100 m (328 ft).

Turn the headlight switch to the or posi-



tion and turn the fog light switch to the  position ①. The front fog lights and indicator light will come on. For additional information, see "Warning/indicator lights and audible reminders" earlier in this section.



To turn the front fog lights off, turn the fog light switch to the OFF position.

REAR FOG LIGHT

The rear fog light should only be used when visibility is seriously reduced – generally, to less than 100 m (328 ft).

Type A (without front fog lights)

To turn the rear fog light on:

1. Turn the headlight switch to the  position.
2. Turn the fog light switch to the  position ①:
 - The rear fog light and indicator light will come on
 - The fog light switch will return to the "OFF" position (—)

To turn the rear fog light off:





- Turn the fog light switch to the  position ① again:
- The rear fog light and indicator light will switch off
 - The fog light switch will return to the "OFF" position (—)

NOTE



If the headlight switch is turned from the  position, the rear fog light will switch off automatically.

Type B (with front fog lights)

To turn the rear fog light on:

1. Turn the headlight switch to the  or  position.
2. Turn the fog light switch to the  position ②:
 - The rear and front fog lights and both indicator lights will come on
 - The fog light switch will return to the  position ①

To turn the rear fog light off:

- Turn the fog light switch to the  position ② again:
- The rear fog light and indicator light will switch off
 - The fog light switch will return to the  position ①

NOTE

If the headlight switch is turned to the OFF position, the rear fog light will switch off automatically.

For additional information, see "Warning/indicator lights and audible reminders" earlier in this section.

HEADLIGHT AIMING CONTROL

HEADLIGHT AIMING CONTROL SWITCH (where fitted)

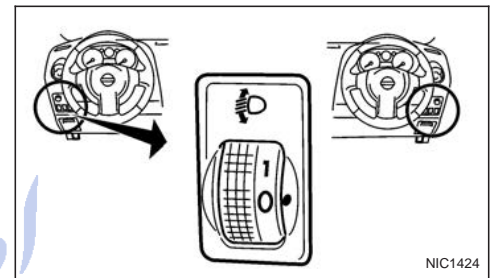

Depending on the number of occupants in the vehicle and the load it is carrying, the headlight axis may be higher than desired. If the vehicle is travelling on a hilly road, the headlights may directly hit the rear-view mirror of the vehicle ahead or the windscreen of an oncoming vehicle. The light axis can be lowered using the switch located on the driver's side of the instrument panel, next to the steering wheel.

The higher the number designated on the switch, the lower the axis.

When travelling with no heavy load on a flat road, select position 0.

AUTOMATIC AIMING CONTROL (xenon headlights)

Vehicles with xenon headlights are equipped with an automatic levelling system. The headlight axis is controlled automatically.

NISSAN recommends consulting local regulations on the use of lights.

HEADLIGHT CLEANER (where fitted)

To clean the headlights, pull the windscreen washer switch towards you while the headlight switch is in the  position and the ignition switch is in the ON position.

NOTE

The headlight cleaner will automatically operate every fifth operation of the wiper and washer switch.

See "Wiper and washer switch" earlier in this section.

CAUTION

- Do not operate the cleaner continuously for more than 15 seconds.
- Do not operate the cleaner if the washer fluid reservoir is empty or frozen.

See "Window washer fluid/headlight cleaner fluid (where fitted)" in the "8. Maintenance and do-it-yourself" section for details on refilling the reservoir tank.

HAZARD WARNING FLASHER SWITCH

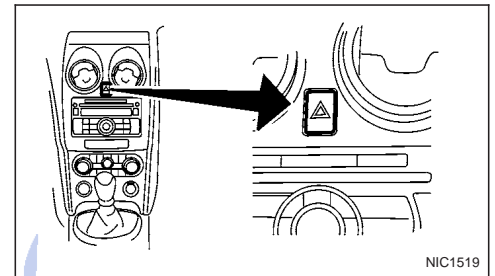

Push the switch on to warn other drivers when you must stop or park under emergency conditions. All direction indicator lights will flash.

FarmaSOS.com



HORN

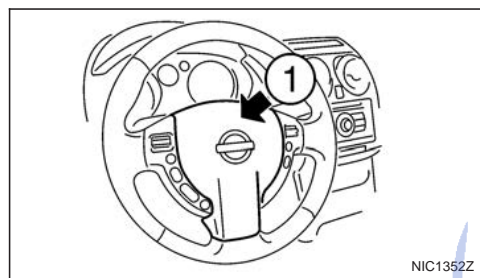

To sound the horn, push the centre pad area ① of the steering wheel.

SEAT HEATING (where fitted)

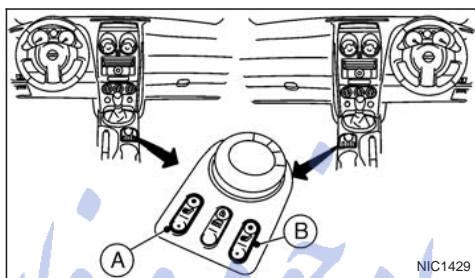

The front seats are warmed by built-in heaters.

The switches are located on the centre console and can be operated independently from each other (A for the left-hand side seat, B for the right-hand side seat).

1. Turn the ignition switch to the ON position.

NOTE

The seat heater can only be activated when the ignition switch is in the ON position.

2. Start the engine.
3. Select the heat range:
 - Press the forward part of the switch (large dot) to activate the "HIGH" heat setting.
 - Press the rear part of the switch (small dot) to activate the "LOW" heat setting.
 - For no heat, the switch has a central "OFF" position between "HIGH" and "LOW".

4. The seat heater switches illuminate when either heat setting is selected and will remain on as long as the switch is on.
5. When the vehicle's interior has warmed-up, or before you leave the vehicle, be sure to turn the seat heater system off.

CAUTION

- Do not use the seat heater system for a long period of time when the engine is not running, otherwise the battery could run down.
- Do not put anything on the seat that insulates the heat, such as a blanket, cushion, seat cover, etc. Otherwise, the seat may overheat.
- Do not place anything hard or heavy on the seat or pierce it with a pin or similar object. This may damage the heater.
- Any liquid spilled on a heated seat should be removed immediately with a dry cloth.
- When cleaning the seat, never use benzene, thinner or any similar materials.
- If any abnormalities are found or the heating does not operate, turn off the switch and have the system checked by a NISSAN dealer or qualified workshop.

POWER OUTLET

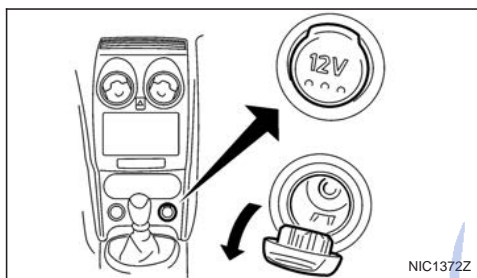

Front row

NIC1372Z

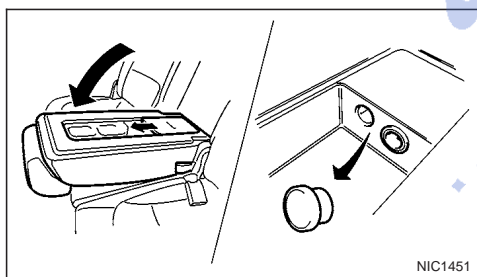

2nd row (7-seater)

NIC1451

- Do not use with accessories that exceed a 12 volt, 120 W (10 A) power draw. Do not use double adaptors or more than one electrical accessory.
- Use this power outlet with the engine running (do not use for extended periods of time with the engine stopped or idling).
- Avoid using when the air conditioner, headlights or rear window defogger are on.
- When not in use, be sure that the cap is closed. Do not allow water to come into contact with the outlet.
- Before inserting or disconnecting a plug, be sure to turn off the power switch of the electrical accessory being used or the Acc power of the vehicle.
- Fully push the plug in sufficiently. If sufficient contact is not made, the plug may overheat or the internal temperature fuse may blow.

WARNING

Take care as the power outlet and plug may be hot during or immediately after use.

CAUTION

- This power outlet is not designed for use with a cigarette lighter unit.

STORAGE

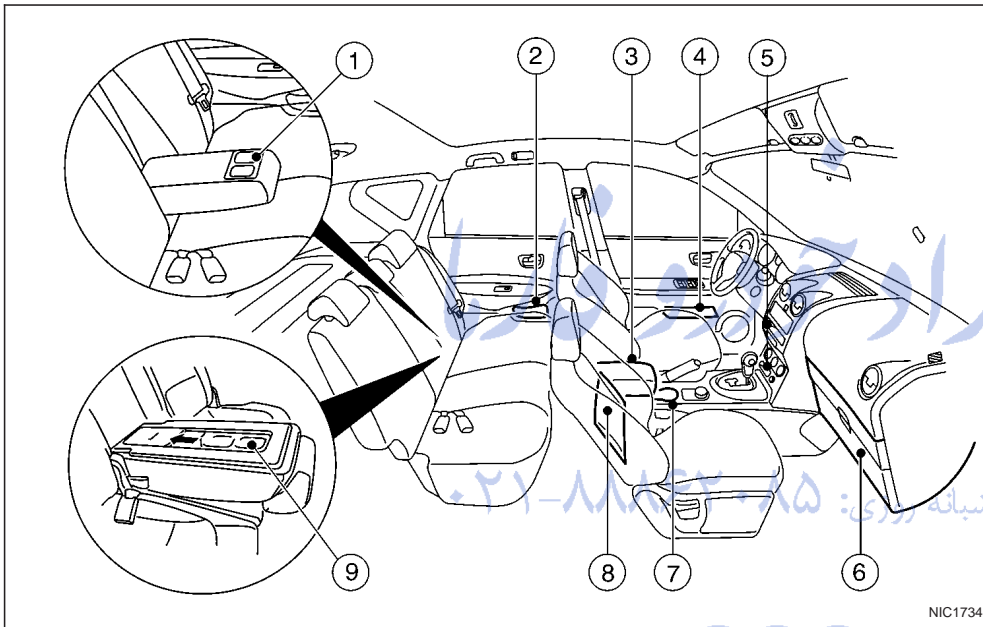

STORAGE TRAYS

- ① Rear cup holders (5-seater)
- ② Bottle holder
- ③ Console box
- ④ Map pocket
- ⑤ Storage trays*

⑥ Glove box, Cool box*, Sunglasses holder

⑦ Front cup holders

⑧ Seat pockets*

⑨ Rear cup holders (7-seater)

* where fitted

The layout illustrated is for the Left-Hand Drive

(LHD) model. On the Right-Hand Drive (RHD) model, these components are located on the opposite side.

! WARNING

Do not place sharp objects in the trays to help prevent injury in an accident or sudden stop.

GLOVE BOX

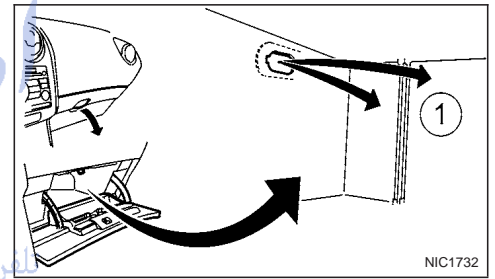

! WARNING

Keep the glove box lid closed while driving to help prevent injury in an accident or a sudden stop.

To open the glove box, lift the latch and lower the lid.

Cool box (where fitted)

When the engine is running and the air conditioning is switched on, cool air will enter the glove box through the opening as illustrated ①.

Sunglasses holder



WARNING

- The sunglasses holder should not be used while driving so that full attention may be given to vehicle operation.
- Do not leave sunglasses in the sunglasses holder while parking in direct sunlight. The heat may damage the sunglasses.

The glove box contains a sunglasses storage area, which is accessible when the glove box is open.

CONSOLE BOX



WARNING

The centre console box should not be used while driving so that full attention may be given to vehicle operation.

Pull the lid up to open the console box.

CUP HOLDERS



WARNING

Cup holders should not be used while driving so that full attention may be given to vehicle operation.

To access the rear cup holders (where fitted), lower the centre armrest.

CAUTION

- Avoid abrupt starting and braking when the cup holder is being used to prevent spillage. If the liquid is hot, it can scald you or your passenger.
- Use only soft cups in the cup holder. Hard objects can injure you in an accident.

BOTTLE HOLDER

CAUTION

- Do not use the bottle holder for any other objects that could be thrown about in the vehicle and possibly injure people during sudden braking or an accident.
- Do not use the bottle holder for open liquid containers.

MAP POCKET (where fitted)

Map pockets are located in the doors.

SEAT POCKET (where fitted)

A seat pocket (where fitted) is located on the back or side of the driver and/or passenger seat.

ROOF RAIL (where fitted)

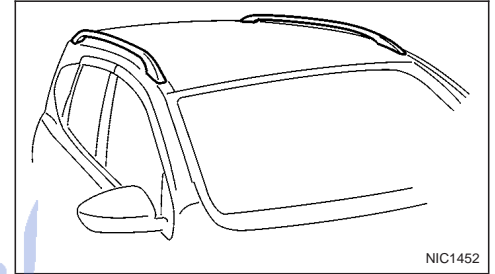

Luggage can be carried on the roof by securing crossbars to the roof rail. Follow all crossbar manufacturers instructions for installing and use of the crossbars. The roof rail is designed to carry loads (luggage plus crossbars) below 75 kg (165 lb). Overloading may cause damage to the vehicle.



REAR PARCEL SHELF (where fitted)

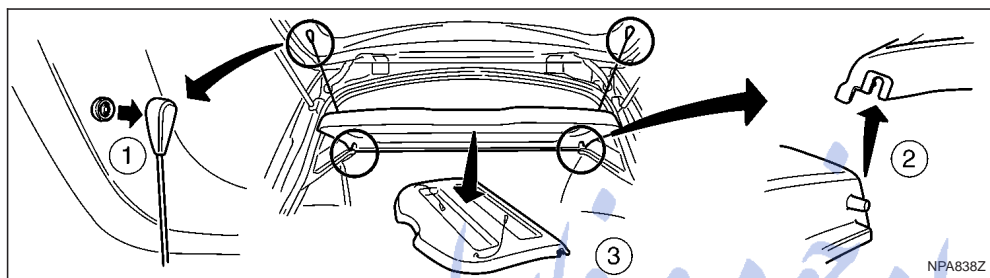

! WARNING

Never put anything on the rear parcel shelf, no matter how small. Any object on it could cause an injury in an accident or when the brakes are applied suddenly.

Removal:

1. Open the back door (see "Back door lock" earlier in this section).
2. Detach both of the ropes (left and right) ① from the inside of the back door.
3. Detach the parcel shelf from the rear seatback fasteners ② by carefully pulling the corners upwards.
4. Lift the parcel shelf ③ up and rotate horizontally to remove through the back door opening.

CAUTION

Make sure the rear parcel shelf is carefully stored when not in use in order to prevent any damage.

Installation:

1. Open the back door.
2. Position the parcel shelf ③ over the rear seatback fasteners ② and push downwards until they "click" into place.
3. Attach the corresponding ropes to each side ① of the back door.
4. Close the back door (see "Back door lock" earlier in this section).

TONNEAU COVER (where fitted)

! WARNING

- Never put anything on the tonneau cover, no matter how small. Any object on it could cause an injury in case of an accident or if the brakes are applied suddenly.
- Do not leave the tonneau cover in position when it is disengaged from the grooves.
- Properly secure all cargo to help prevent it from sliding or shifting. Do not place cargo higher than the seatbacks. In a sudden stop or collision, unsecured cargo could cause personal injury
- The child restraint top tether strap may be damaged by contact with the tonneau cover or items in the luggage compartment area. Remove the tonneau cover from the vehicle or store it in its storage space. Also, secure any loose items in the luggage compartment. Your child could be seriously injured or killed in a collision if the top tether strap is damaged.

The tonneau cover keeps the luggage compartment contents hidden from the outside. It can only be used when the 3rd row seats are folded down.

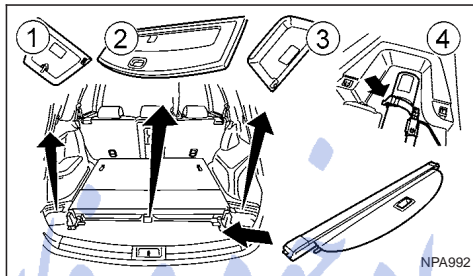
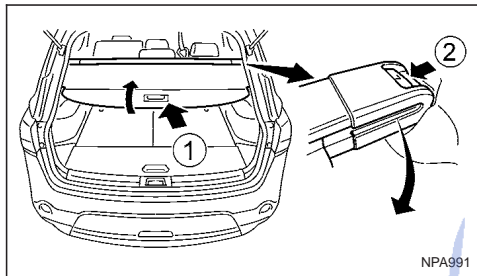

Removal:

- 1) Pull the tonneau cover at the grip ① slightly up and backward, then slide it forward.
- 2) Push the sliding button ② at the right hand side to disengage it from the groove.
- 3) Then remove the tonneau cover ③ completely.

To fit the tonneau cover, first fit the left side, then at the right hand side, push it into the groove ② until the stem engages.

Storage:

- 1) Remove the luggage floor covers ①, ② and ③.
- 2) Fit the tonneau cover under the luggage compartment floor in it's storage space. Use the straps ④ at the right and left side.
- 3) Replace the covers ①, ② and ③.

WINDOWS

POWER WINDOWS

The power window switches are located on the door panel and will only operate when the ignition switch is in the ON position.



- Make sure to remove the key from the ignition switch and take it with you when leaving the vehicle. If children are left unattended inside the vehicle they could unknowingly activate switches.
- Make sure that all passengers have their hands, etc. inside the vehicle while it is in motion and before closing the windows. Use the power window lock switch to prevent unexpected use of the power windows.
- It is recommended to instruct all occupants in the safe operation of power windows with particular emphasis given to the safety and supervision of children.

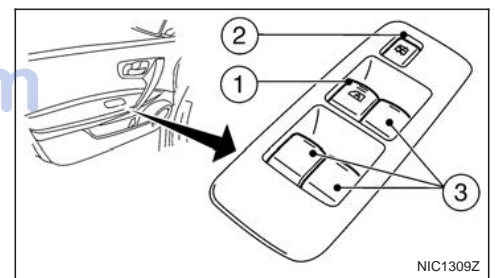

Left hand drive models

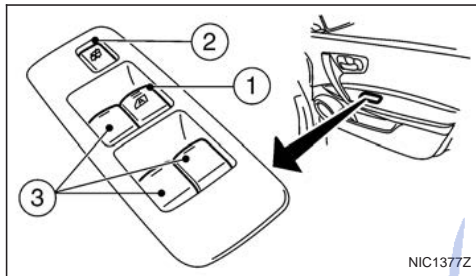

Right hand drive models

NIC1377Z

Driver's side main switch

- ① Driver's side automatic window switch
- ② Power window lock switch
- ③ Passenger power window switches

The driver's side control panel is equipped with switches to operate the passenger power windows and a power window lock switch.

Automatic operation:



WARNING

Make sure there is no obstruction when closing the driver's side window using the driver's side automatic window switch.

To fully open the driver's side window, completely push down or pull up the driver's side automatic window switch and release it; it does not need to be held. The window will automatically open or close all the way.

To stop the window opening or closing, just push or pull the switch in the opposite direction.

Auto-reverse function:

When the control unit detects an object obstructing the driver's side window, as it closes, the window will open automatically.

The auto-reverse function remains active only when the driver's side window is being closed automatically.



WARNING

- There are some areas immediately before the closed position where squeezing cannot be detected. Be careful not to pinch your fingers.
- The auto-reverse function does not work when the window is closed manually (holding the switch in the close position).

CAUTION

Depending on the environment or driving conditions, the auto-reverse function may be activated if an impact or load similar to something being caught in the window occurs.

Power window lock switch:

Dependant on the vehicle specifications, when the power window lock function is activated, either:

- the rear passenger window switches are disabled; or
- the front and rear passenger window switches are disabled.

To activate the power window lock function, push the switch.

To cancel the power window lock function, push the switch again.

System reinitialisation:

The driver's side main power window system will require reinitialisation whenever:

- The power window system does not function properly for example the auto-reverse function is not working.
- The battery cable is reconnected.
- The fuse is replaced.

Perform the following procedure to initialise the power window system.

1. Turn the ignition switch to the ON position
2. Close the door.
3. Push down and hold the driver's side window switch until the window glass is completely lowered then release the switch.
4. **In one continuous operation**, pull up and hold the driver's side window switch until the window glass is completely closed and continue holding the switch for a further 5 seconds.
5. The system is now reinitialised.

If the reinitialisation procedure cannot be performed successfully, take your vehicle to a NISSAN dealer or qualified workshop.

C-VIEW® GLASS ROOF (where fitted)

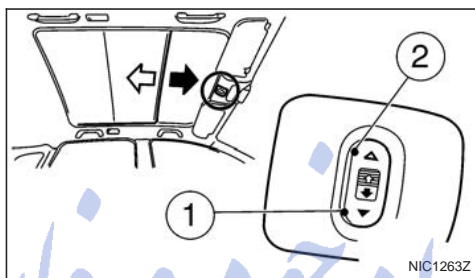
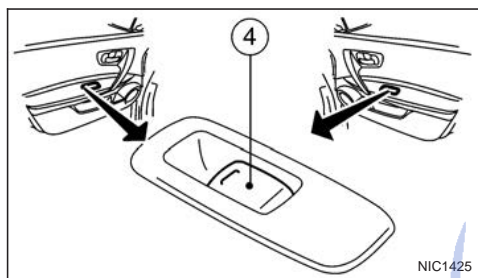

Passenger power window switches

The passenger power window switches (4) operate the corresponding passenger window only.

To open or close the window, push and hold the switch down or up.

To stop the window from opening or closing, simply release the switch.

- ① Open
- ② Close

CAUTION

- Do not place heavy objects on the C-View® glass or surrounding area.
- Do not hang from the sunshade or hang any objects from it. It may cause damage or deformation to the sunshade.
- Close the sunshade when you leave the vehicle for extended periods of time to prevent the inside of the vehicle from reaching high temperatures.

SUNSHADE OPERATION

The C-View® sunshade operates only when the ignition switch is in the ON position.

⚠ WARNING

Never allow hands or fingers, or any part of your body within operating range of the sunshade. You could be injured.

Opening and closing

Manual control:

To open the sunshade press and hold the "OPEN" side of the switch (1). To stop the sunshade from opening fully, release the switch.

To close the sunshade, press and hold the "CLOSE" side of the switch (2). To stop the sunshade from closing fully, release the switch.

Automatic operation:

To fully open or close the sunshade automatically, press briefly on the open or close side of the switch and then release. To stop the sunshade from opening or closing, press either side of the switch.

Auto-reverse function:

When the control unit detects something caught in the sunshade, the sunshade will open automatically.

NOTE

The auto-reverse function remains active whether the sunshade is being closed manually or automatically.

SYSTEM REINITIALISATION

The C-View® sunshade will require reinitialisation whenever:

- The sunshade system does not function properly.
- The battery cable is reconnected.
- The fuse is replaced.

Perform the following procedure to initialise the sunshade system.

1. Make sure the vehicle battery is connected.
2. Turn the ignition switch to the ON position.
3. Press and hold the "CLOSE" side of the switch.

The system will now proceed as follows:

- a. If open, the sunshade will start moving to the closed position.
 - b. After a few seconds, the system will fully open the sunshade.
 - c. From the fully open position, it returns to the closed position.
4. After reaching the closed position, release the sunshade switch.
 5. The sunshade system is now reinitialised.

NOTE

Do not disconnect the power for at least 2 seconds.

If the reinitialisation procedure cannot be performed successfully, take your vehicle to a NISSAN dealer or qualified workshop.

INTERIOR LIGHTS

CAUTION

Do not use for extended periods of time with the engine stopped. This could discharge the battery.

NOTE

The interior lights will go off after approximately 15 minutes unless the ignition switch is in the Acc or ON position.

FRONT ROOM LIGHT

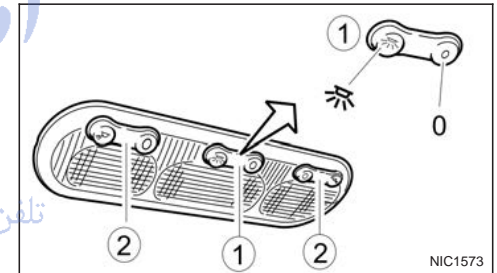

The room light has a three-position switch ①.

Position	Lighting
	Light is always on
"Middle"	Light comes on when a door is opened
0	Light remains off

Room light timer (where fitted)



The room light will stay on for approximately 30 seconds when:

- The ignition is switched off.
- The doors are unlocked.
- Any door is opened and then closed.

The timer is cancelled, and the interior light will turn off when:

- The doors are locked.
- The ignition switch is turned to the ON position.

MAP LIGHTS (where fitted)

To switch on the map light, press either  or  of the switches ②.

To turn the map light off, press 0

REAR ROOM/READING LIGHT

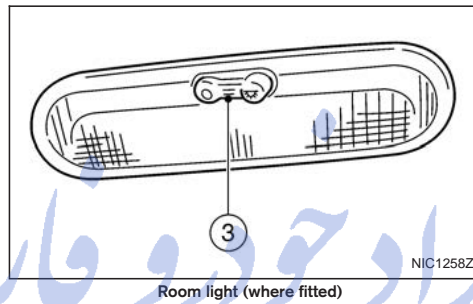

VANITY MIRROR LIGHT (where fitted)

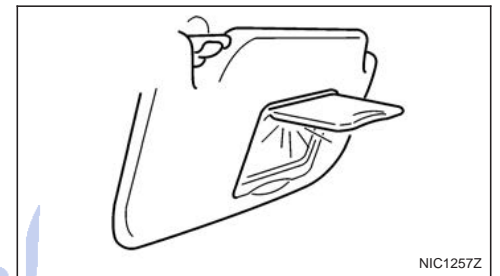

The light on the vanity mirror will turn on when the cover is opened.

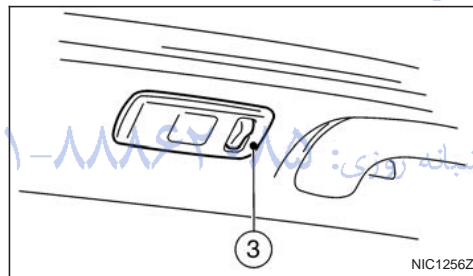

The light can be switched on or off by pressing the switch ③.

LUGGAGE COMPARTMENT LIGHT

The light comes on automatically when the back door is opened.



3 Pre-driving checks and adjustments

Keys.....	3-2	Inside door handle	3-10
NISSAN Anti-Theft System (NATS)* key	3-2	Power door lock switch	3-10
Intelligent Key (where fitted)	3-2	Child safety lock — rear doors.....	3-11
Key number	3-3	Back door lock	3-12
New keys	3-3	Security system	3-13
Emergency/mechanical key (Intelligent Key models)	3-3	Alarm system (where fitted)	3-13
Integrated keyfob/remote control system.....	3-3	NISSAN Anti-Theft System (NATS).....	3-13
Switching from Convenience mode to		Bonnet release	3-14
Anti-hijack mode	3-4	Fuel filler lid	3-15
Using the remote keyless entry system.....	3-5	Fuel filler lid opener lever	3-15
Locking the doors.....	3-5	Fuel filler cap	3-15
Unlocking the doors.....	3-5	Handbrake lever	3-16
Keyfob operation failure	3-6	Steering wheel.....	3-16
Intelligent Key system (where fitted)	3-6	Sun visors.....	3-17
Intelligent Key operating range	3-6	Mirrors.....	3-17
Using Intelligent Key system.....	3-7	Inside rear-view mirror	3-17
Locking/unlocking	3-7	Automatic anti-dazzling inside mirror (where fitted)	3-17
Starting the engine with the Intelligent Key	3-8	Outside rear-view mirrors.....	3-17
Door locks	3-9	Vanity mirror	3-19
Super Lock system (RHD models).....	3-9		
Locking/unlocking with the key (vehicle dead battery).....	3-9		

KEYS

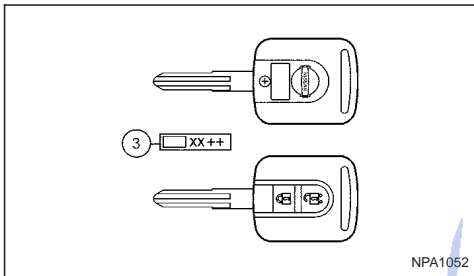

Integrated keyfob and key number plate

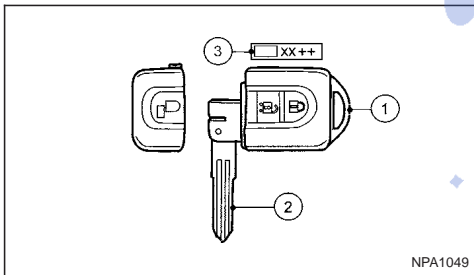

Intelligent Key with emergency/mechanical key

1. Intelligent Key
2. Emergency/Mechanical key (inside the Intelligent Key), see "Emergency/mechanical key (Intelligent Key models)" later in this section
3. Key number plate

NISSAN ANTI-THEFT SYSTEM (NATS)* KEY

Your vehicle can only be driven with the keys specific to your vehicle. Only NISSAN Anti-Theft System (NATS)* keys can be used with your vehicle (see "Security system" later in this section).

INTELLIGENT KEY (where fitted)

Your vehicle can only be driven with the Intelligent Keys, which are registered to your vehicle's Intelligent Key system components and NISSAN Anti-Theft System (NATS*) components. As many as 4 Intelligent Keys can be registered and used with one vehicle. The new keys must be registered by a NISSAN dealer or qualified workshop prior to use with the Intelligent Key system and NATS of your vehicle. Since the registration process requires erasing all memory in the Intelligent Key components when registering new keys, be sure to take all Intelligent Keys that you have to the NISSAN dealer or qualified workshop.

*: Immobilizer

CAUTION

- Be sure to carry the Intelligent Key with you. Do not leave the vehicle with the Intelligent Key inside.
- Be sure to carry the Intelligent Key with you when driving. The Intelligent Key is a precision device with a built-in transmitter. To avoid damaging it, please note the following.

- The Intelligent Key is water resistant; however, wetting may damage the Intelligent Key. If the Intelligent Key gets wet, immediately wipe until it is completely dry.
- Do not allow the Intelligent Key to come into contact with water or salt water this could affect the system function.
- Do not bend, drop or strike it against another object.
- Do not place the Intelligent Key for an extended period in a place where temperatures exceed 60°C (140°F).
- Do not change or modify the Intelligent Key.
- Do not use a magnetic key holder.
- Do not place the Intelligent Key near equipment that produces a magnetic field such as a TV, audio equipment and personal computers.
- If an Intelligent Key is lost or stolen, NISSAN recommends erasing the ID code of that Intelligent Key. This will prevent the Intelligent Key from unauthorised use to unlock the vehicle. For information regarding the erasing procedure, please contact a NISSAN dealer or qualified workshop.

3-2 Pre-driving checks and adjustments



KEY NUMBER

A key number plate ③ is supplied with your key

Record the key number on the "Security Information" page at the end of this manual and keep it in a safe place, but **not in the vehicle**. The key can only be duplicated using an original key or the original key number. The key number is required when you have lost all of the keys and do not have the original key to duplicate from. If the key is lost, or you need extra keys, provide an original key or the key number to a NISSAN dealer or qualified workshop.

NISSAN does not record key numbers, so it is very important that you keep a record of your key number.

NEW KEYS

As many as four NATS keys can be registered to one vehicle at any one time. New keys must be registered to the NATS components of your vehicle by a NISSAN dealer.

When registering a new key at a NISSAN dealer, you are requested to bring all of your NATS keys with you. This is necessary because the registration process will erase and reprogram the memory of your vehicle's NATS components.

NOTE

A key number is only required if you have lost all of your keys and do not have one to duplicate from. If you still have a key, this key can be duplicated by a NISSAN dealer.

EMERGENCY/MECHANICAL KEY (Intelligent Key models)

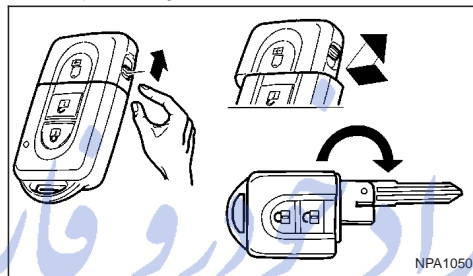

The emergency key can be used to unlock the driver's door and start the engine in emergency situations (e.g. Intelligent Key dead battery).

To use the mechanical key, release the lock knob located on the side of the Intelligent Key then slide and remove the cap. Unfold the mechanical key from its housing until it locks in place.

Use the mechanical key to lock or unlock the doors. (See "Door locks" later in this section.)

For further details on accessing and using the emergency key, see "Ignition knob (where fitted)" in the "5. Starting and driving" section.

NOTE

For the driver side door, it is normal for the key not to go all the way into the key cylinder.

INTEGRATED KEYFOB/REMOTE CONTROL SYSTEM

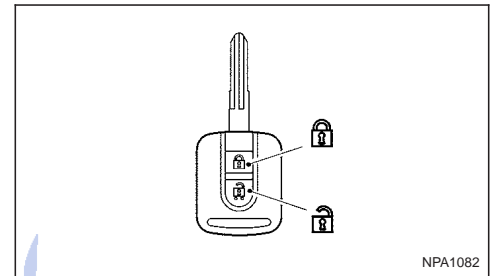

Integrated keyfob

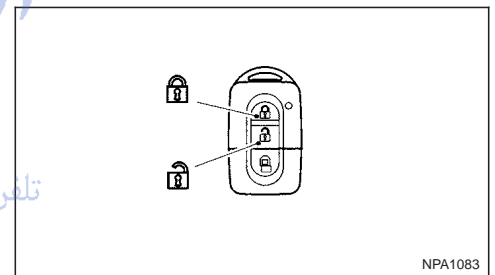

Intelligent key



The remote keyless entry system can operate all door locks (including the back door) using the integrated keyfob. The integrated keyfob can operate at a distance of approximately 5 m (15 ft) from the vehicle (the effective distance depends upon the conditions around the vehicle and the state of the keyfob battery).

As many as 5 remote controllers can be used with one vehicle. For information about the purchase and

use of additional remote controllers, contact a NISSAN dealer or qualified workshop.

The integrated keyfob will not function under the following conditions:

- When the distance between the integrated keyfob and vehicle is more than approximately 5 m (15 ft).
- When the integrated keyfob battery is discharged.
- When the key is in the ignition switch.

All doors can be locked or unlocked from the outside by pressing the "LOCK"  or "UNLOCK"  button on the integrated keyfob.

For Super Lock system models only (RHD models):

When the vehicle is occupied, never lock the doors with the integrated keyfob. Doing so will trap the occupants, since the Super Lock system prevents the doors from being opened from the inside.

 **WARNING**

Only operate the integrated keyfob lock button in full and clear view of the vehicle to prevent anybody being trapped inside the vehicle.

CAUTION

- When locking the doors using the integrated keyfob, be sure not to leave the key in the vehicle.

- Always remove the ignition key or Intelligent Key, close all windows before operating the keyfob door lock system.
- Ensure that the driver's door is securely closed before operating the integrated keyfob door lock system for correct operation of the system.
- Do not allow the integrated keyfob, which contains electrical components, to come into contact with water or salt water. This could affect the system function.
- Do not drop the integrated keyfob.
- Do not strike the integrated keyfob sharply against another object.
- Do not place the integrated keyfob for an extended period in an area where temperatures exceed 60°C (140°F).

If a integrated keyfob is lost or stolen, NISSAN recommends erasing the ID code of that integrated keyfob from the vehicle. This may prevent the unauthorised use of the integrated keyfob to unlock the vehicle. For information regarding the erasing procedure, contact a NISSAN dealer or qualified workshop.



For information regarding the replacement of a battery, see "Battery" in the "8. Maintenance and do-it-yourself" section.

SWITCHING FROM CONVENIENCE MODE TO ANTI-HIJACK MODE

Selective unlock or "Anti-hijack" mode allows the remote unlocking of only the driver's door to prevent an attacker from entering the vehicle via an unlocked passenger door.

As default, the unlock mode will be set to "Convenience" mode (all doors will unlock). Follow the instructions below to switch between convenience mode and anti-hijack mode.

Ⓐ Key with integrated keyfob (from outside the vehicle)

1. Turn the ignition switch to the "OFF" position.
2. Press and hold both the "LOCK"  and "UNLOCK"  buttons for 5 seconds.



Setting anti-hijack mode:

- The direction indicators flash **once**.

Setting convenience mode:

- The direction indicators flash **three times**.

Ⓑ Intelligent Key

1. Turn the ignition switch from ON to LOCK and exit the vehicle.
2. From outside the vehicle, lock the vehicle using the integrated keyfob "LOCK" button .
3. Press and hold both the "LOCK"  and "UNLOCK"  buttons for 10 seconds.
4. Within 3 seconds, press and hold the driver's

3-4 Pre-driving checks and adjustments



door outside lock switch until the direction indicators flash to confirm the setting mode. Then release the driver's door outside lock switch.

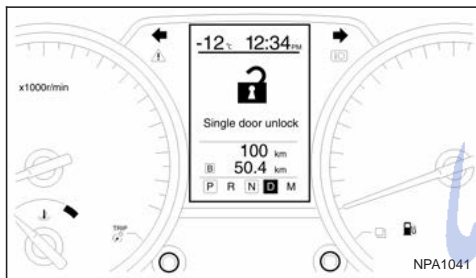

Setting convenience mode:

- The message [All door unlock] appears on the vehicle information display (inside the vehicle).

See "Warning/indicator lights and audible reminders" in the "2. Instruments and controls" section and "Vehicle information display" in the "2. Instruments and controls" section for further details.

USING THE REMOTE KEYLESS ENTRY SYSTEM



WARNING

Super Lock system equipped models:

Failure to follow the precautions below may lead to hazardous situations. Make sure the Super Lock system activation is always conducted safely.

- When the vehicle is occupied, never lock the doors with the integrated keyfob. Doing so will trap the occupants, since the Super Lock system prevents the doors from being opened from the inside of the vehicle.
- Only operate the integrated keyfob "LOCK" button when there is a clear view of the vehicle. This is to prevent anybody from being trapped inside the vehicle through the Super Lock system activation.

For further details on the Super Lock system see "Super Lock system (RHD models)" later in this section.

5. Setting anti-hijack mode:

- The message [All door unlock] appears on the vehicle information display (inside the vehicle).

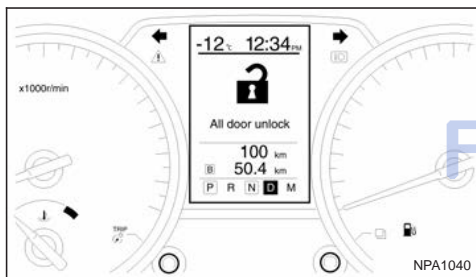

LOCKING THE DOORS

CAUTION

Before operating the keyfob remote control:

- Remove the ignition key or Intelligent Key from the vehicle and close all windows.
- Check that the driver's door is securely closed.

Push the "LOCK" button  on the integrated keyfob.

- All the doors lock.
- The direction indicators flash once.

If the "LOCK" button  is pushed with all the doors locked, the direction indicators will flash once to remind you that the doors are already locked.

UNLOCKING THE DOORS

Convenience mode

Push the "UNLOCK" button  on the integrated keyfob.

- The message [All door unlock] appears in the vehicle information display.
- All doors unlock.
- The direction indicators flash twice.

Anti-hijack mode

1. Push the "UNLOCK" button  on the integrated keyfob.

- The message [Single door unlock] appears in the vehicle information display.
 - Only the driver's door unlocks.
 - The direction indicators flash twice, quickly.
2. Push the "UNLOCK" button  on the integrated keyfob again.
- All doors unlock.
 - The direction indicators flash twice.

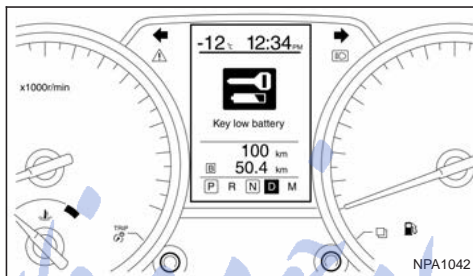

NOTE

See Intelligent Key detection warning, Intelligent Key low battery warning or Intelligent Key system fault warning in "Vehicle information display" earlier in this section for more information.

INTELLIGENT KEY SYSTEM (where fitted)

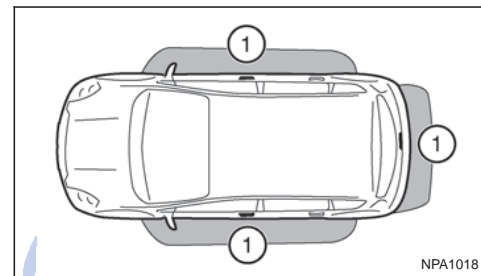

The Intelligent Key system is a convenient keyless entry system that allows you to operate your vehicle without using an actual key.

WARNING

Radio waves could adversely affect electric medical equipment. Those who use a pacemaker should contact the electric medical equipment manufacturer for the possible influences before use.

INTELLIGENT KEY OPERATING RANGE

The Intelligent Key functions can only be used when the Intelligent Key is within the specified operating range from the request switch ①.

When the Intelligent Key battery is discharged or strong radio waves are present near the operating location, the Intelligent Key system's operating range becomes narrower, and the Intelligent Key may not function properly.

Auto-relock:

An auto-relock function will operate 2 minutes after a full or partial unlock, if no further user action is taken. The auto-relock will be cancelled if any door is opened or the key is inserted into the ignition.

KEYFOB OPERATION FAILURE

The keyfob may not work properly if:

- **The keyfob battery is low.** See "Integrated keyfob/Intelligent Key battery replacement" in the "8. Maintenance and do-it-yourself" section for keyfob battery replacement instructions and the required battery type.
- **The locking/unlocking system has been used continuously.** An anti lock-abuse system prevents the lock motors from overheating and disables the keyfob locking operation for a short period of time if the system is used continuously.
- **The door handle is being pulled while the keyfob is being operated.**
- **The vehicle's battery is dead.**

3-6 Pre-driving checks and adjustments

The operating range is within 80 cm (31.50 in) from each request switch ①.

If the Intelligent Key is too close to the door glass, door handle or rear bumper, the request switches may not function.

When the Intelligent Key is within the operating range, it is possible for anyone, even someone who does not carry the Intelligent Key, to push the request switch to lock/unlock the doors including the back door.

USING INTELLIGENT KEY SYSTEM

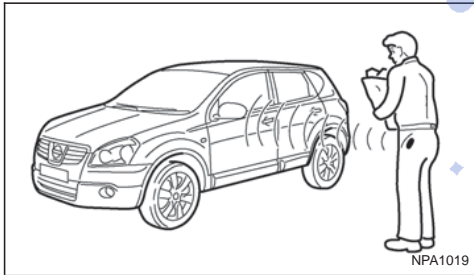

The request switch will not function under the following conditions:

- When the Intelligent Key is left inside the vehicle
- When the Intelligent Key is not within the operational range
- When any door is open or not closed securely
- When the Intelligent Key battery is discharged

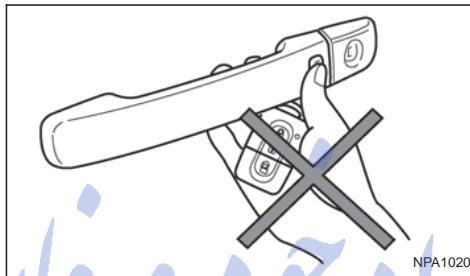

- Do not push the door handle request switch with the Intelligent Key held in your hand as illustrated. The close distance to the door handle will cause the Intelligent Key system to have difficulty recognising that the Intelligent Key is outside the vehicle.
- After locking the doors using the door handle request switch, make sure that the doors have been securely locked by operating the door handles.
- To prevent the Intelligent Key from being left inside the vehicle, make sure you carry the key with you and then lock the doors.
- Do not pull the door handle before pushing the door handle request switch. The door will be unlocked but will not open. Release the door handle once and pull it again to open the door.

LOCKING/UNLOCKING

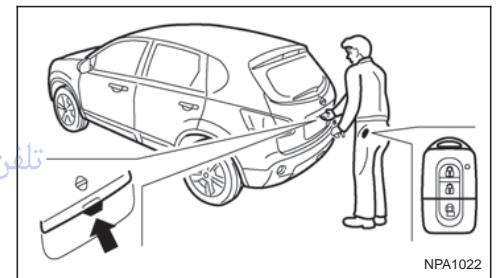
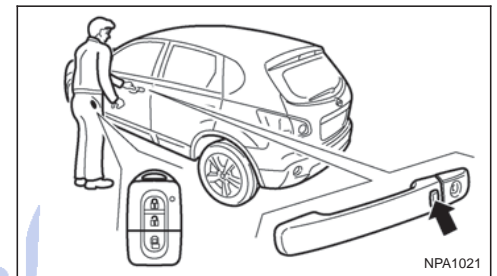

The Intelligent Key system allows you to lock and unlock the driver's door, passenger doors, or back door without activating the integrated keyfob or using the emergency key (driver's door key cylinder).

When near the vehicle, the Intelligent Key sends an ID code that allows the owner to manually lock/unlock the vehicle by pressing the driver's door, front passenger's door or back door outside lock switch.

Locking the doors

1. Make sure you have the Intelligent Key with you when exiting the vehicle.
2. Close all doors.
3. Press any of the outside lock switches (front doors or back door).
 - All the doors lock.
 - The direction indicators flash once.
 - **Super Lock system equipped models:** The Super Lock system will be activated

CAUTION

Do not leave the duplicate Intelligent Key inside the vehicle as the locking procedure logic will not work.

NOTE

If the Intelligent Key is left in the vehicle and the door/back door outside lock switch is pressed, a buzzer will sound, warning the owner that the Intelligent Key has been left inside the vehicle.

Unlocking the doors

For details on setting the unlock mode (anti-hijack or convenience mode) see "Switching from Convenience mode to Anti-hijack mode" earlier in this section.

Convenience mode:

Push the door/back door outside lock switch.

- All doors unlock.
- The direction indicators flash twice.
- The message [All door unlock] appears in the vehicle information display.

Anti-hijack mode:

1. Push the door/back door outside lock switch.
 - The corresponding door unlocks
 - The direction indicators flash twice quickly
 - The message [Single door unlock] appears in the vehicle information display.
2. Push the door/back door outside lock switch again within 5 seconds.
 - All doors unlock.
 - The direction indicators flash twice, slowly.

NOTE

External interference may impair the Intelligent Key's operation. In this case, use the emergency key located in the Intelligent Key integrated key-fob. See "Door locks" later in this section for further details.

CAUTION

- **Make sure the Intelligent Key battery is in good condition. Note that battery life may vary depending on condition, amount of use, ambient temperature, etc.**

- **The Intelligent Key contains a miniature radio transmitter that may be affected when placed near metal objects.**
- **Keep the Intelligent Key away from mobile phones, laptop computers and other metal objects or electronics.**

STARTING THE ENGINE WITH THE INTELLIGENT KEY

See "Ignition knob (where fitted)" in the "5. Starting and driving" section.

CAUTION

- **Make sure you carry the Intelligent Key with you when starting and driving the vehicle.**
- **If the Intelligent Key is too far away from the passenger compartment, the vehicle may not start. See "Intelligent Key operating range" in the "3. Pre-driving checks and adjustments" section**

3-8 Pre-driving checks and adjustments



DOOR LOCKS

SUPER LOCK SYSTEM (RHD models)



WARNING

Super Lock system equipped models:

Failure to follow the precautions below may lead to hazardous situations. Make sure the Super Lock system activation is always conducted safely.

- When the vehicle is occupied, never lock the doors with the integrated keyfob. Doing so will trap the occupants, since the Super Lock system prevents the doors from being opened from the inside of the vehicle.
- Only operate the integrated keyfob "LOCK" button when there is a clear view of the vehicle. This is to prevent anybody from being trapped inside the vehicle through the Super Lock system activation.

Pressing the "LOCK" button  on the integrated keyfob or locking the doors using one of the outside door lock switches (Intelligent Key models) will activate the Super Lock system.

When the Super Lock system is active, none of the doors can be opened from inside the vehicle. This provides additional security in case of theft or break-in.

The Super Lock system will be released when all the doors are unlocked using the integrated keyfob or an outside door lock switch (Intelligent Key models).

Emergency situations

If the Super Lock system is activated while you are inside the vehicle, for example by a traffic accident or other unexpected circumstances, follow the instructions below.

To release the Super Lock system:

- Insert the key into the ignition switch and turn it to the ON position.

All doors can now be unlocked and opened from inside the vehicle.

- Remove the key from the ignition switch and unlock the doors using the integrated keyfob "UNLOCK" button .

All doors can now be opened from inside the vehicle.

To unlock and open the driver's door from inside the vehicle while the Super Lock system is active:

1. Open or break the driver's door window.
2. Insert the key into the outside door key cylinder and turn it towards the rear of the vehicle.
3. The driver's door will unlock and can now be opened from inside the vehicle.

Locking without activating the Super Lock system



WARNING

Do not leave the key inside the vehicle when leaving the vehicle.

Locking the doors using the door key cylinder or power door lock switch will not activate the Super Lock system. See "Power door lock switch" later in this section for further information.

LOCKING/UNLOCKING WITH THE KEY (vehicle dead battery)

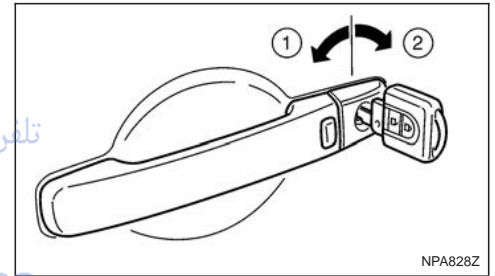

WARNING

- When leaving the vehicle, do not leave the key inside the vehicle.
- Never leave children unattended in a vehicle and always be sure you have your keys with you when leaving. If an emergency occurs it may be more difficult to help them otherwise.

The driver's door can be locked/unlocked from outside using the key/emergency key if the vehicle's battery is dead.

To lock the door, insert the key into the driver's door key cylinder and turn it towards the front of the vehicle ①.

To unlock the door, turn the key towards the rear of the vehicle ②.

See "Ignition knob (where fitted)" in the "5. Starting and driving" section for instructions on accessing the Intelligent Key system Emergency key.

CAUTION

The alarm system will be triggered when the door is opened using the key (NISSAN alarm equipped models). To stop the alarm, turn the ignition key to the ON position or press the unlock ② button on the integrated keyfob.

Initialising the system after vehicle battery loading or replacement

After recharging or replacing the battery, you should release (initialise) the system by:

- Inserting the key into the ignition switch and then turning it to the ON position.
- Unlocking the vehicle using the integrated keyfob.

INSIDE DOOR HANDLE

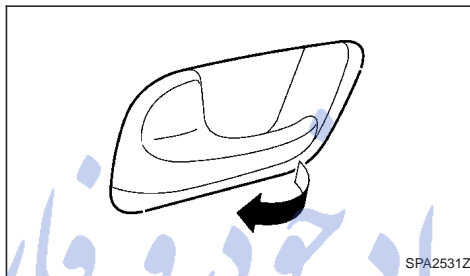

To unlock and open the door, pull the inside door handle as illustrated.

With Super Lock (where fitted)

The door cannot be opened when the Super Lock system is activated.

POWER DOOR LOCK SWITCH

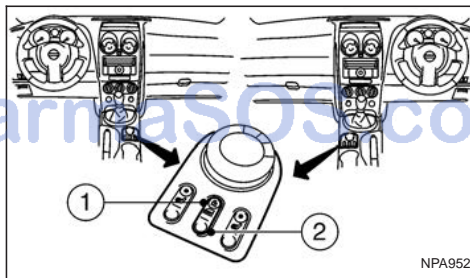

① Press to lock

② Press to unlock



WARNING

When leaving the vehicle, do not leave the key inside the vehicle.

The power door lock switch, located on the centre console, can be used to lock ① or unlock ② all doors simultaneously from inside the vehicle.

The switch will illuminate when the doors are locked.

A chime will sound and the doors will not lock if the power door lock switch is pressed while any door other than the driver's door is open.

NOTE

Models without the Super Lock system: If a door is manually opened from inside after having pressed the integrated keyfob "LOCK" button, the door will unlock, but the power door lock switch will remain illuminated.

Locking the doors when leaving the vehicle

It is possible to lock all doors using the power door lock switch when leaving the vehicle:

1. Open the driver's door, remove the key from the ignition or the Intelligent Key (where fitted) from the passenger compartment.
2. Press the "LOCK" side of the power door lock switch ①.

– All doors except the driver's door lock

3-10 Pre-driving checks and adjustments



3. Close the driver's door.

- The driver's door locks
- The power door lock switch illuminates
- **Super Lock system models:** The Super Lock system is not activated
- **Intelligent Key models:** If the Intelligent Key has been left inside the vehicle, all doors will unlock and an alarm will sound

Super Lock equipped models (RHD models)

If the doors are locked using the integrated keyfob "LOCK" button or an outside door lock switch (Intelligent Key models), the Super Lock system will be activated. The power door lock switch will illuminate to indicate that all doors are locked, but it will not be possible to use the power door lock switch to unlock the doors.

Locking the doors with the power door lock switch will not activate the Super Lock system.

Drive away door locking

When active, the drive away door locking function will automatically lock all doors when the vehicle speed exceeds 12 km/h (7 MPH).

All doors will be automatically unlocked when a front door is opened except in anti-hijack mode (only the driver's door or front passenger door will unlock); or when opening a rear passenger door from the inside.

When "UNLOCK", on the power door lock switch,

is pressed the drive away door locking system will not lock the doors again until a door is opened and closed.

To activate or deactivate drive-away door locking:

1. Unlock the doors.
2. Turn the ignition switch ON.

3. Activation

Press and hold the "LOCK" side of the power door lock switch ① for 5 seconds.

Deactivation

Press and hold the "UNLOCK" side of the power door lock switch ① for 5 seconds.

4. A buzzer will sound if activation or deactivation was successful.

Once activated, drive-away door locking will function on every subsequent trip.

CHILD SAFETY LOCK — REAR DOORS

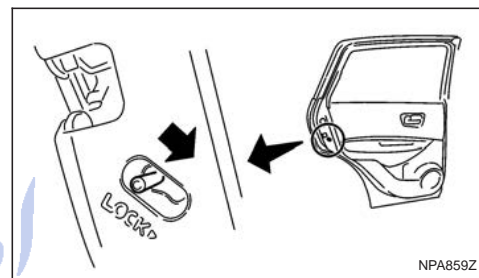

The child safety lock helps prevent doors from being opened accidentally, especially when small children are in the vehicle.

When the switch is in the LOCK position, the rear door can only be opened from the outside.

BACK DOOR LOCK

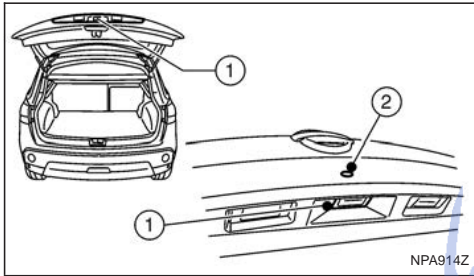

WARNING

- Always check that the back door has been properly closed to prevent it from opening while driving.
- Do not drive with the back door opened. This could allow dangerous exhaust gases to be drawn into the vehicle.
- Closely supervise children when they are around the vehicle to prevent them from playing and being locked in the luggage compartment where they could be seriously injured. Keep the vehicle locked, with the back door closed, when not in use, and prevent children's access to the vehicle's keys.

The power door lock system allows you to lock or unlock all doors including the back door.

The back door can be manually released from the

outside, when the vehicle is not locked, by operating the microswitch ① located on the back door underside.

NOTE

The back door cannot be opened from the outside when the power door lock switch is activated. An audible warning is heard when the microswitch ① located on the back door underside is operated.

To open the back door, unlock it with one of the following operations, then push the back door microswitch ① and pull up to open it.

- Push the back door outside lock switch ② (where fitted). See "Intelligent Key system (where fitted)" earlier in this section.
- Push the "UNLOCK" button on the Intelligent Key (where fitted). See "Intelligent Key system (where fitted)" earlier in this section.
- Push the "UNLOCK" button on the integrated keyfob (where fitted). See "Integrated keyfob/remote control system" earlier in this section.
- Unlock all the doors using the key.
- Push the power door lock switch to the "UNLOCK" position.

To close the back door, pull down and then push closed until securely locked.

Vehicle dead battery – Back door lock release lever (where fitted)

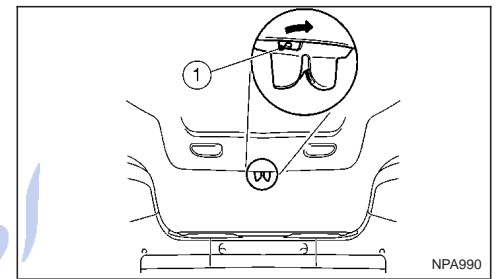

The vehicle's back door can be unlocked from the inside when the battery is dead. Tilt the seatback down. Remove the cover from the lock and slide the release lever ① as illustrated. See "Rear seat(s) in the "1. Safety – seats, seat belts and supplemental restraint system" section for more information regarding the seat operation.

SECURITY SYSTEM

ALARM SYSTEM (where fitted)

The alarm system provides visual and audible alarm signals if parts of the vehicle are disturbed.

How to arm the alarm system

1. Close all doors, windows, back door and bonnet.
2. Lock the vehicle using the keyfob (lock button), for additional information, see "Integrated keyfob/remote control system" in the "3. Pre-driving checks and adjustments" section.

NOTE

If the vehicle is not fully locked, a door/bonnet/back door is open, or the ignition switch is in the ON position (after arming the system), the buzzer will sound. After correctly closing, the buzzer will stop.

Alarm system operation

The system will give the following alarm:

- The siren sounds intermittently and all direction indicators will flash.
- The alarm automatically turns off after 28 seconds.

The alarm is activated when:

- The volumetric sensing system (ultrasonic sensors) is triggered.
- Any door/the back door is opened.
- The bonnet is opened.

- The ignition circuit is turned on without the owner's key being used.

The alarm system will stop when:

- The vehicle is unlocked using the keyfob unlock button.
- The ignition switch or ignition knob is turned to the ON position with a registered NATS key.

If the system does not operate as described above, have it checked by your NISSAN dealer or qualified workshop.

Ultrasonic sensors (where fitted)

The ultrasonic sensors (volumetric sensing) detect movements in the passenger's compartment. When the alarm system is set to the armed position, it will automatically switch on the ultrasonic sensors.

It is possible to exclude the ultrasonic sensors (e.g. when leaving pets inside the car).

To exclude the ultrasonic sensors:

1. Turn the ignition switch 3 times within 7 seconds from the "OFF" to the ON position.
2. Close the door(s)/bonnet/back door and press the lock button  on the keyfob to lock all doors/back door.

The ultrasonic sensors are now excluded from the alarm system. All other functions of the system remain activated until the alarm system is disarmed again.

NISSAN ANTI-THEFT SYSTEM (NATS)

The NISSAN Anti-Theft System (NATS)* will not allow the engine to start without the use of the registered NATS key.

* Immobilizer

If the engine fails to start using the registered NATS key, it may be due to interference from another NATS key, an automated toll road device or an automated payment device on the key ring. Restart the engine using the following procedure:

1. Leave the ignition switch in the ON position for approximately 5 seconds.
2. Turn the ignition switch to the "OFF" or LOCK position and wait approximately 5 seconds.
3. Repeat steps 1 and 2.
4. Restart the engine while holding the device (which may have caused the interference) separated from the registered NATS key or NATS Intelligent Key (where fitted).

If this procedure allows the engine to start, NISSAN recommends placing the registered NATS key or NATS Intelligent Key (where fitted) on a separate key-ring to avoid interference from other devices.

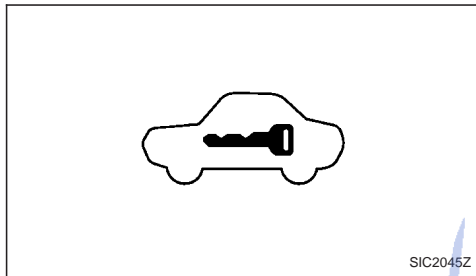

Meters and gauges (Type A)

SIC2045Z

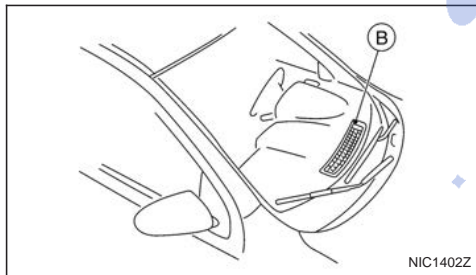

Driver's side (Type B)

NIC1402Z

- The NATS security indicator light (Type B) is located on the Driver's side of the dashboard and blinks whenever the ignition switch is in the LOCK, "OFF" or Acc position.

If the NISSAN Anti-Theft System (NATS) is malfunctioning, this light will remain on while the ignition switch is in the ON position.

If the light remains on and/or the engine will not start, see your NISSAN dealer for NATS service as soon as possible. Please bring all NATS keys or NATS Intelligent Keys when visiting your NISSAN dealer for service.

Additional information for RHD models

If the NATS is malfunctioning, this light will turn on after flashing six times while the ignition switch is in the ON position.

However, if the NATS security warning light turns off after the light has remained on for 15 minutes, there is a 10 second time slot to start the engine after the ignition is turned off. See your NISSAN dealer for NATS service as soon as possible.

BONNET RELEASE

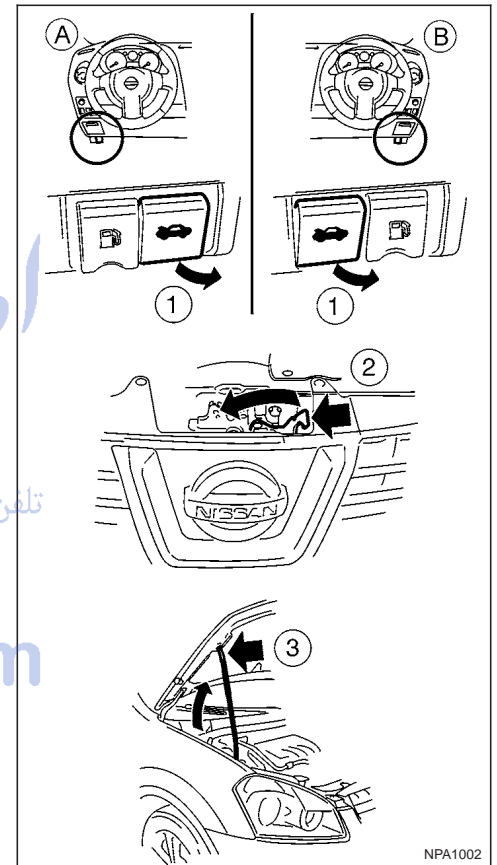

NPA1002

NATS security warning/indicator light (where fitted)

One of the following functions (depending on the vehicle specifications) indicates that the vehicle is equipped with NATS:

- The NATS security warning light (Type A) is located in the meter panel and blinks whenever the ignition switch is in the LOCK, "OFF" or Acc position.

3-14 Pre-driving checks and adjustments

FarmaSOS.com

FUEL FILLER LID

Ⓐ LHD models

Ⓑ RHD models

1. Pull the bonnet lock release lever ①, located below the instrument panel on the driver's side; the bonnet will spring up slightly.
2. Slide the lever ②, at the front of the bonnet, with your fingertips and raise the bonnet.
3. Insert the support rod ③ into the slot on the underside of the bonnet.
4. When closing the bonnet, replace the support rod in its original position, then slowly close the bonnet and make sure it locks into place.

WARNING

Always check whether the bonnet is closed and locked securely to prevent it from opening while driving. The vehicle should only be operated with the bonnet securely closed.

FUEL FILLER LID OPENER LEVER

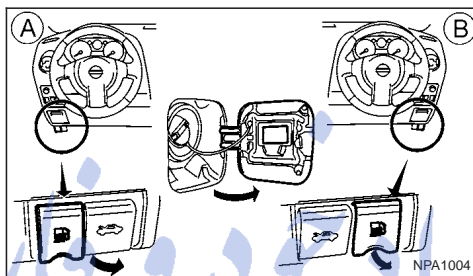

Ⓐ LHD models

Ⓑ RHD models

To open the fuel filler lid, pull up the opener lever, located below the instrument panel on the driver's side. To lock, close the fuel filler lid securely.

FUEL FILLER CAP

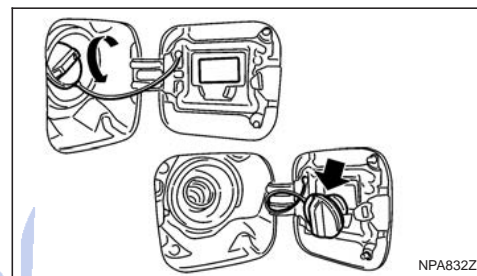

The fuel filler cap is a ratcheting type. Tighten the cap clockwise until ratcheting clicks are heard.

Put the fuel filler cap on the cap holder as illustrated while refuelling.

WARNING

- Fuel is extremely flammable and highly explosive under certain conditions. Always stop the engine and do not smoke or allow open flames or sparks near the vehicle when refuelling.
- Fuel may be under pressure. Turn the cap half a turn and wait for any hissing sound to stop, in order to prevent fuel from spraying out and causing possible personal injury.
- Use only a NISSAN fuel filler cap or exact equivalent as a replacement. It has a built-in safety valve needed for proper operation of

HANDBRAKE LEVER

the fuel system and emission control system. An incorrect cap can result in a serious malfunction and possible injury.

CAUTION

If fuel is spilled on the vehicle body, flush it away with water to avoid paint damage.

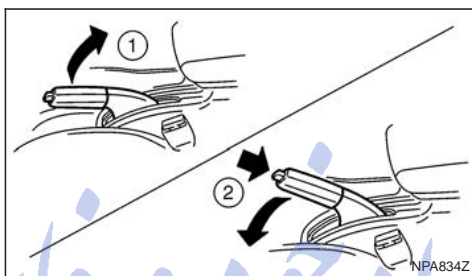

To apply: Pull the lever up ①.

To release: Pull the lever up slightly, push the button ② and lower completely.

Before driving, check that the brake warning light (ⓐ) goes out. For additional information, see "Warning/indicator lights and audible reminders" in the "2. Instruments and controls" section.

NOTE

A buzzer will sound if the vehicle is driven without releasing the handbrake. See "Audible reminders" in the "2. Instruments and controls" section.

STEERING WHEEL

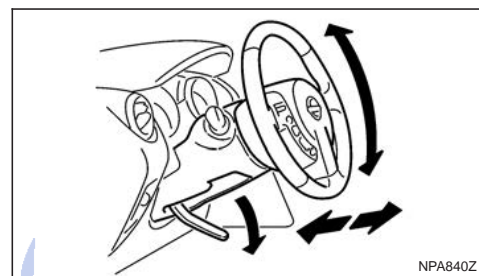

⚠ WARNING

Do not adjust the steering wheel while driving. You could lose control of your vehicle and cause an accident.

Release the lock lever as illustrated and adjust the steering wheel to the desired position (up or down, forwards or backwards). Firmly push the lock lever back into position to lock the steering wheel in place.

SUN VISORS

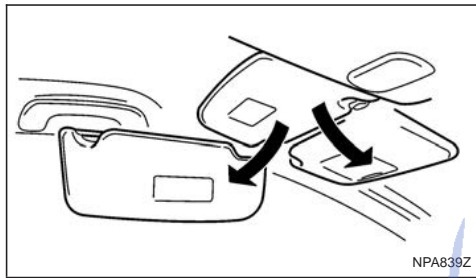

CAUTION

Do not store the sun visor before returning it to its original position.

1. To block out glare from the front, move the main sun visor downwards.
2. To block glare from the side, remove the main sun visor from the centre mount and move it to the side.

MIRRORS

INSIDE REAR-VIEW MIRROR

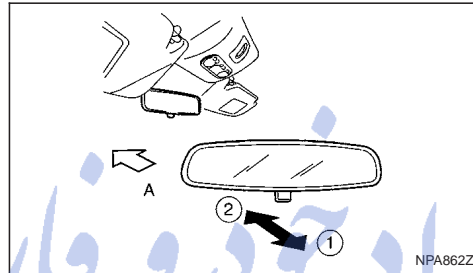

- ① Night position
- ② Day position
- A Front of the vehicle

The night position ① will reduce glare from the headlights of vehicles behind you at night.



Only use the night position ① when necessary, as it reduces rear-view clarity.

AUTOMATIC ANTI-DAZZLING INSIDE MIRROR (where fitted)

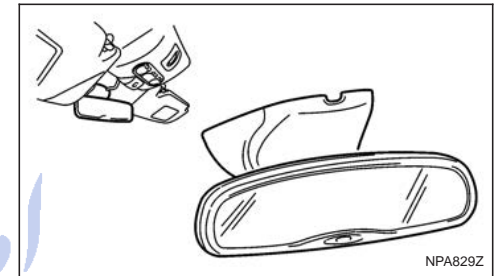

The inside mirror is designed so that it automatically adjusts the reflection according to the intensity of the following vehicle's headlights.

CAUTION

Do not hang any object on the mirror or spray glass cleaner directly on the mirror. Doing so will reduce the sensitivity of the sensor, resulting in improper operation.

OUTSIDE REAR-VIEW MIRRORS



- Check the position of all mirrors before driving. Altering their position while driving could distract your attention from the driving operation.
- Objects viewed in the outside mirrors are closer than they appear.

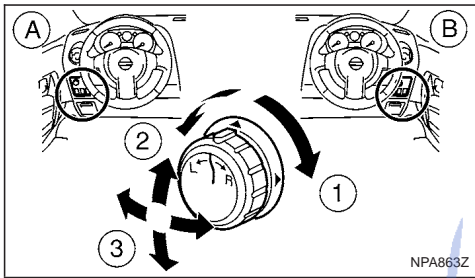

Adjusting — Remote control

- (A) LHD models
- (B) RHD models

The outside rear-view mirror control will only operate when the ignition switch is in the Acc or ON position.

Turn the control to the right (1) or to the left (2) to select the right or left outside rear-view mirror, then adjust the mirror to the desired position by tilting the control as illustrated (3).

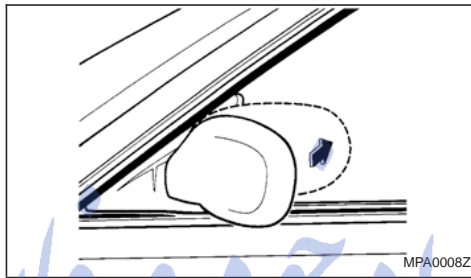

Folding — Manual control

Fold the outside rear-view mirror by pushing it towards the rear of the vehicle.

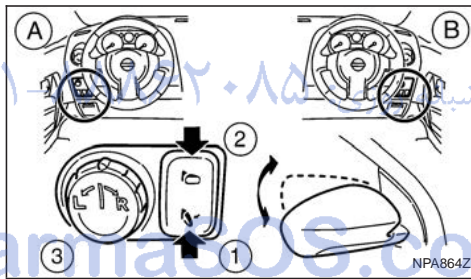

Folding — Remote control (where fitted)

Fold the outside rear-view mirror by pushing the CLOSE side (1) of the switch.

To return the mirror to its original position, push the OPEN side (2) of the switch.

NOTE

If the mirror becomes displaced from its adjusted position, use the following procedure to return it to the correct geared position:

1. Fold (or CLOSE (1)) the mirror electronically using the remote control switch.
2. Wait until the mirror emits a strong noise, this confirms that the mirror has correctly engaged.
3. Fold out (or OPEN (2)) the mirror electronically using the remote control switch.
4. Adjust the mirror to the correct driving angle using the remote control (3).



VANITY MIRROR

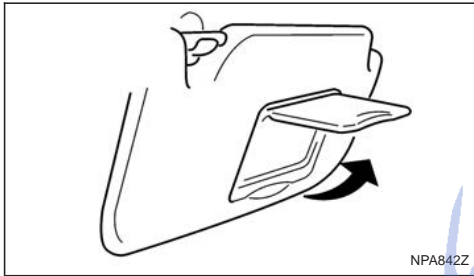

Left hand drive

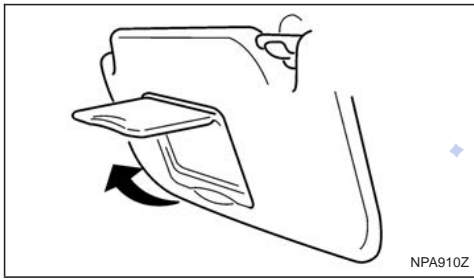

Right hand drive

To use the front vanity mirror, pull down the sun visor and lift up the cover.

امداد خودرو فارما

تلفن شبانه روزی: ۰۲۱-۸۸۸۶۲۰۸۵

FarmaSOS.com

NOTE

امداد خودرو فارما

تلفن شبانه روزی: ۰۲۱-۸۸۸۶۲۰۸۵

FarmaSOS.com

3-20 Pre-driving checks and adjustments



4 Display screen, heater and air conditioner, and audio system

Rear-view monitor (where fitted).....	4-2	Compact Disc (CD) operation	4-27
How to read the displayed lines	4-2	AUX socket	4-29
Rear-view monitor setting.....	4-3	Bluetooth® mobile phone feature.....	4-29
Operating tips.....	4-3	FM AM radio with CD player.....	4-30
Around view monitor (where fitted).....	4-4	Anti-theft system	4-31
Operation	4-6	Audio main operation	4-31
Guide lines	4-7	Radio operation	4-32
Difference between predictive and actual		SETUP button	4-33
distances.....	4-9	Compact Disc (CD) operation	4-35
How to adjust the screen view	4-11	AUX socket	4-36
Operating tips.....	4-11	USB Memory operation (where fitted)	4-37
Vents.....	4-12	iPod® player operation (where fitted).....	4-37
Side and centre vents	4-12	Bluetooth® operation.....	4-39
High level vent (where fitted).....	4-12	NISSAN Connect (where fitted).....	4-43
Heater and air conditioner operation	4-12	Steering wheel switch for audio control (where	
Manual air conditioner.....	4-13	fitted).....	4-43
Automatic air conditioner (where fitted)	4-18	Main operation.....	4-43
Audio system.....	4-21	Car phone or CB radio	4-44
Audio operation precautions	4-21	Mobile phone integration for LW-MW-FM radio	
Antenna.....	4-22	with CD player or 6 CD changer (Type A).....	4-44
LW-MW-FM radio with CD player or 6 CD		Bluetooth® mobile phone feature.....	4-44
changer	4-23	Mobile phone integration for FM AM radio with	
Anti-theft system	4-24	CD player.....	4-52
Audio main operation	4-24	Bluetooth® mobile phone feature.....	4-52
Radio operation	4-24	Hands-free telephone control.....	4-53
MENU button.....	4-27	Steering wheel switches (where fitted).....	4-55

REAR-VIEW MONITOR (where fitted)

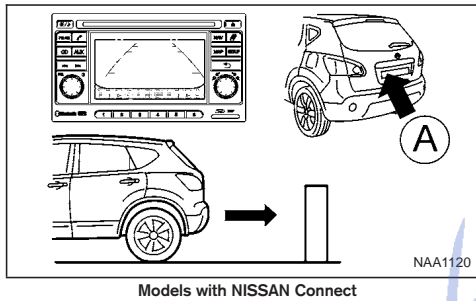

(A) Camera

When the gear or selector lever (AT or CVT) is moved into the R (Reverse) position, the monitor (NISSAN Connect display) shows the view from the rear of the vehicle.

The system is designed as an aid to the driver in detecting large stationary objects. It is intended to help avoid damaging the vehicle when reversing. However, the system will not detect small objects below the bumper and may not detect objects close to the bumper or on the ground.

⚠ WARNING

- The rear-view camera is a convenience but it is not a substitute for proper reversing. Always turn your head and visually check that the manoeuvre is safe to do so before reversing. Always reverse slowly.
- The distance from the objects viewed in the rear-view monitor differs from actual distance

because of the use of wide-angle lens. Objects in the rear-view monitor will appear visually reversed compared to those viewed in the inside and outside mirrors.

- Make sure that the back door is securely closed when reversing.
- The area below the bumper and corner areas of the bumper cannot be viewed on the rear-view monitor because of its monitoring range limitation.
- Do not put anything on the rear-view camera. The rear-view camera is installed above the number plate.
- When washing the vehicle with high pressure water, be sure not to spray it around the camera. Otherwise, water may enter the camera unit causing possibly water condensation on the lens, a malfunction, a fire or an electric shock.
- Do not strike the camera. It is a precision instrument. Otherwise, it may malfunction or cause damage resulting in a fire or an electric shock.

CAUTION

There is a transparent cover over the camera lens. Do not scratch the cover when cleaning dirt or snow from it.

HOW TO READ THE DISPLAYED LINES

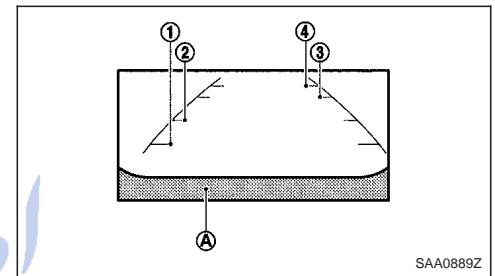

⚠ WARNING

- Use the displayed lines as a reference. The lines are highly affected by the number of occupants, fuel level, vehicle position, road condition and road grade. Always check with your eyes directly around the vehicle while reversing.
- The distance guide line and the vehicle width line should be used as a reference only when the vehicle is on a level paved surface. The distance viewed on the monitor is for reference only and may be different than the actual distance between the vehicle and displayed objects.
- When reversing the vehicle up a hill, objects viewed in the monitor are further than they appear. When reversing the vehicle down a hill, objects viewed in the monitor are closer

4-2 Display screen, heater and air conditioner, and audio system



than they appear. Use the inside mirror or glance over your shoulder to properly judge distances to other objects.

The lines which are displayed on the monitor, indicate the vehicle's clearance and distance between the obstacle and the bumper (A).

Displayed lines indicate the distances between the obstacle and the bumper as follows:

- ① 0.5 m (1.5 ft) – red
- ② 1 m (3 ft) – yellow
- ③ 2 m (7 ft) – green
- ④ 3 m (10 ft) – green

NOTE

- The vehicle clearance lines are wider than the actual clearance.
- The lines are indicated as reference distances to the obstacle.

REAR-VIEW MONITOR SETTING

For details, see the separately provided NISSAN Connect Owner's Manual.

OPERATING TIPS

- When the gear (MT) or selector (AT or CVT) lever is shifted to R (Reverse), the NISSAN Connect display automatically changes to the rear-view monitor mode.
- When the gear (MT) or selector (AT or CVT) lever is returned to a position other than R (Re-

verse), it may take some time until the screen changes. Objects on the screen may be distorted until they are completely displayed.

- When the temperature is extremely high or low, the screen may not clearly display objects. This is not a malfunction.
- When strong light directly enters the camera lens, objects may not be displayed clearly. This is not a malfunction.
- Vertical lines may be seen in objects on the screen. This is due to strong reflected light from the bumper. This is not a malfunction.
- The screen may flicker under fluorescent light. This is not a malfunction.
- The colours of objects on the rear-view monitor may differ somewhat from those of the actual object.
- Objects on the monitor may not be clear in a dark place or at night.
- If dirt, rain or snow attaches to the transparent camera cover, the rear-view monitor may not clearly display objects. Clean the transparent camera cover.
- Do not use alcohol, benzine or thinner to clean the transparent camera cover. This will cause discoloration. To clean the transparent camera cover, wipe with a cloth dampened with diluted mild cleaning agent and then wipe with a dry cloth.

- Do not damage the transparent camera cover as the NISSAN Connect display may be adversely affected.
- Do not use body wax on the transparent camera cover. Wipe off any wax with a clean cloth dampened with mild detergent diluted with water.

AROUND VIEW MONITOR (where fitted)

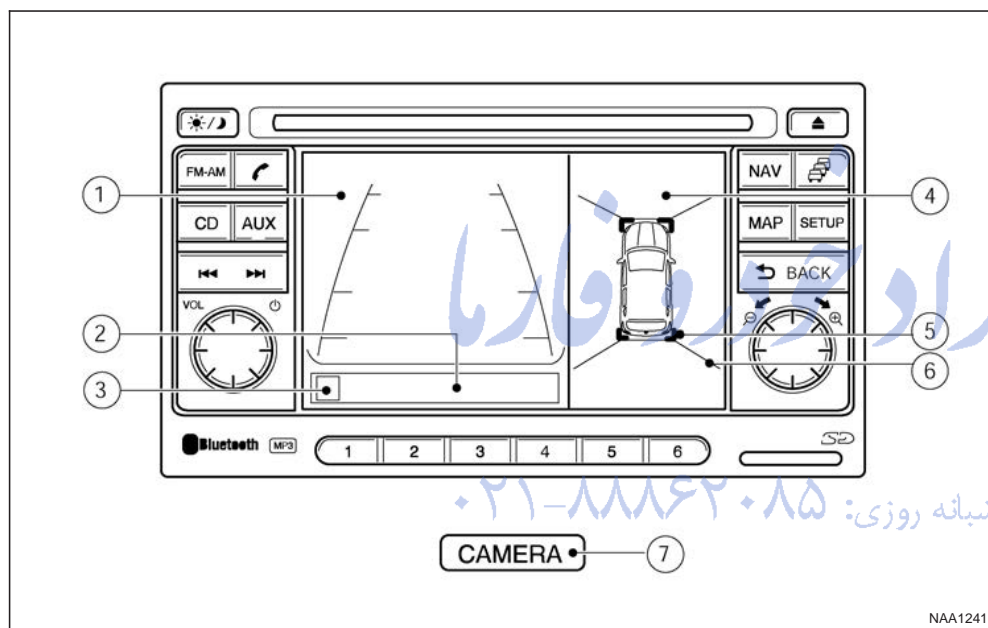

- ① Front or rear view
- ② Warning message
- ③ Front or rear view indicator
- ④ Bird's-eye view or front-side view
- ⑤ Bird's-eye view corner indication
- ⑥ Bird's-eye view corner lines

⑦ <CAMERA> button

When you push the <CAMERA> button or shift the gear selector lever into the R (Reverse) position while the ignition switch is in the ON position, the Around View Monitor operates. The monitor displays various views of the position of the vehicle.

NOTE

At first operation, the corner lines are blinking yellow for about 3 seconds. This is not a malfunction but a reminder to be cautious.

Available views:

- Bird's-eye View
The surrounding view of the vehicle.
 - Front-side View
The view around and ahead of the front passenger's side wheel.
 - Front view
The view to the front of the vehicle.
 - Rear view
The view to the rear of the vehicle.
- The system is designed as an aid to the driver in situations such as slot parking or parallel parking.



WARNING

- The Around View Monitor is intended for day time use. Do not use the system in bad light conditions.
- The Around View Monitor is a convenience but it is not a substitute for proper vehicle operation because it has areas where objects cannot be viewed. Always visually check to be sure that it is safe to move before operating the vehicle. Always operate the vehicle slowly.

4-4 Display screen, heater and air conditioner, and audio system

- Do not use the Around View Monitor with the outside mirror in the stored position, and make sure that the back door is securely closed when operating the vehicle using the Around View Monitor.
- The distance between objects viewed on the Around View Monitor differs from the actual distance.
- The cameras are installed above the front grille, the outside mirrors and above the rear number plate. Do not put anything on or cover the cameras.
- When washing the vehicle with high-pressure water, be sure not to spray it around the cameras. Otherwise, water may enter the camera unit causing water condensation on the lens, a malfunction, fire or an electric shock.
- Do not strike the cameras. They are precision instruments. Doing so could cause a malfunction or cause damage resulting in a fire or an electric shock.

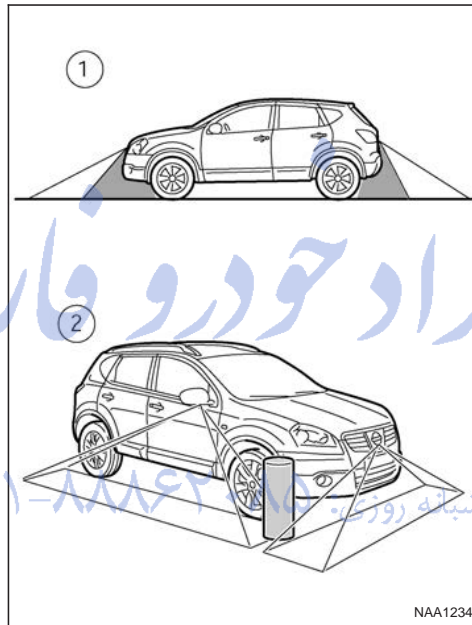

- Due to electromagnetic radiation a red cross might appear in the monitor. This is normal. Check surroundings for safety. Move the vehicle away from the source of the interference if possible. If the red cross does not disappear contact a NISSAN dealer or qualified workshop.

FarmasOS.com

- In some areas the system will not detect objects. When in the front or the rear view display, an object below the bumper or on the ground may not be detected ①. When in the bird's-eye view, a tall object near the seam of the camera detecting areas will not appear in the monitor ②.

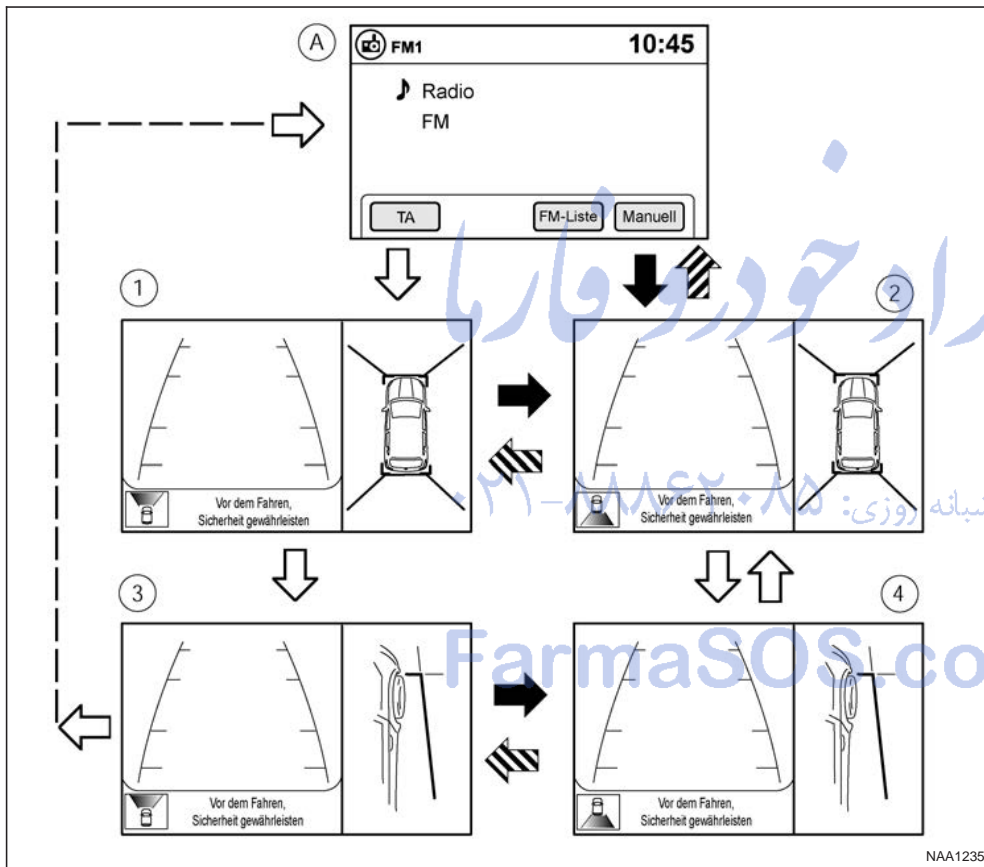

Example for Left-Hand Drive (LHD) models, for the Right-Hand Drive (RHD) models, the screen layout will be opposite.

OPERATION

The Around View Monitor display consists of the front, left, right and rear screens. You can see a combination of different views on the screens as illustrated.

Ⓐ: Audio or navigation screen

①: Front view and bird's-eye view

②: Rear view and bird's-eye view

③: Front view and front side view

④: Rear view and front side view

➡: Gear selector lever into R (Reverse)

↔: Gear selector lever out of R (Reverse)

⏏: Push the <CAMERA> button

There are two ways to start using the Around View monitor:

- Select R (Reverse) gear
- Push the <CAMERA> button

Selecting R (Reverse) gear

- When the gear selector lever is shifted into the R (Reverse) position Around View Monitor starts automatically and the rear view and bird's-eye view are displayed ②.
- The Around View Monitor screen turns off when the gear selector lever is shifted out of the R (Reverse) position Ⓐ.

4-6 Display screen, heater and air conditioner, and audio system



- In R (Reverse) gear rear view and bird's-eye view (2) are shown. The view on the screen on the passenger's side switches to the front side view (4) when the <CAMERA> button is pushed.

Push the <CAMERA> button again to switch back to rear view and bird's-eye view (2).

Pushing the CAMERA button

- When the <CAMERA> button is pushed, Around View Monitor operates and the front view and bird's-eye view are displayed (1).
- The front view and bird's-eye view are displayed (1). The view on the screen on the passenger's side switches to the front-side view when the <CAMERA> button is pushed (3). Pushing the <CAMERA> button again turns the Around View Monitor off.
- To switch the driver's side screen between front view and rear view use the gear selector lever.

GUIDE LINES

WARNING

- The distance guide line and the vehicle width line should be used as a reference only when the vehicle is on a paved, level surface. The distance viewed on the monitor is for reference only and may be different than the actual distance between the vehicle and displayed objects.
- Use the displayed lines and the bird's-eye view as a reference. The lines and the bird's-

eye view are greatly affected by the number of occupants, fuel level, vehicle position, road condition and road grade.

- If the tyres are replaced with different sized tyres, the predictive course line and the bird's-eye view may be displayed incorrectly.
- When driving the vehicle up a hill, objects viewed in the monitor are further than they appear. When driving the vehicle down a hill, objects viewed in the monitor are closer than they appear. Use the mirrors or actually look to properly judge distances to other objects.
- The vehicle width and predictive course lines are wider than the actual width and course.

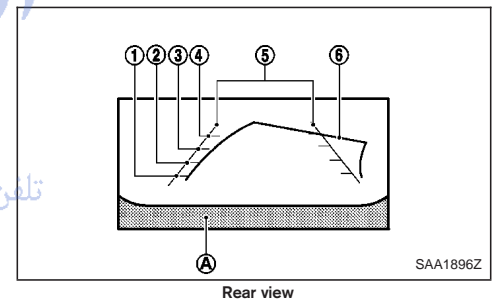
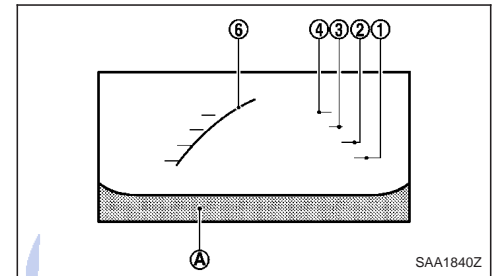

Front and rear view

Guiding lines, which indicate the vehicle width and distances to objects with reference to the vehicle body line (A), are displayed on the monitor.

Distance guide lines:

Indicate distances from the vehicle body.

- Red line (1): approx. 0.5 m (1.5 ft)

- Yellow line ②: approx. 1 m (3 ft)
- Green line ③: approx. 2 m (7 ft)
- Green line ④: approx. 3 m (10 ft)

Vehicle width guide lines ⑤:

Indicate the vehicle width when reversing.

Predictive course lines ⑥:

Indicate the predictive course when operating the vehicle. The predictive course lines will be displayed on the monitor when the steering wheel is turned. The predictive course lines will move depending on how much the steering wheel is turned and will not be displayed while the steering wheel is in the neutral position.

The front view will not be displayed when the vehicle speed is above 10 km/h (6 MPH).

WARNING

- The distance between objects viewed in the rear view differs from actual distance because a wide-angle lens is used. Objects in the rear view will appear visually opposite than when viewed in the rear view and outside mirrors.
- On a snow-covered or slippery road, there may be a difference between the predictive course line and the actual course line.
- If the battery is disconnected or becomes discharged, the predictive course lines may be displayed incorrectly. If this occurs visit a NISSAN dealer or qualified workshop.

- If predictive course lines are displayed incorrectly visit a NISSAN dealer or qualified workshop.
- The displayed lines on the rear view will appear slightly off to the right because the rear view camera is not installed in the rear centre of the vehicle.

NOTE

When the monitor displays the front view and the steering wheel turns about 90 degrees or less from the neutral position, both the right and left predictive course lines ⑥ are displayed. When the steering wheel turns about 90 degrees or more, a line is displayed only on the opposite side of the turn.

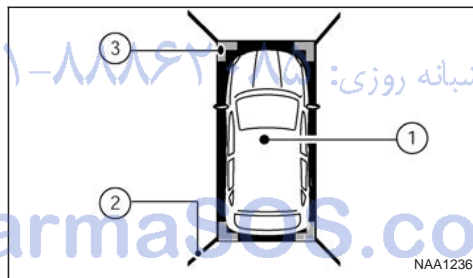

Bird's-eye view

Bird's-eye view

The bird's-eye view shows the overhead view of the vehicle which helps to confirm the vehicle position.

The vehicle icon ① shows the position of the vehicle.

NOTE

The size of the vehicle icon on the bird's-eye view may differ somewhat from the actual vehicle.

The areas that the cameras cannot cover are indicated in black.

At first operation, the corner lines ② on all four corners of the vehicle icon are blinking yellow for about 3 seconds. The four corners ③ of the vehicle are displayed in red.

NOTE

Corner lines ② blink (yellow) on all four corners of the vehicle icon as a reminder to be cautious. This is not a malfunction.

WARNING

- Objects in the bird's-eye view will appear further than the actual distance because the bird's-eye view is a pseudo view that is processed by combining the views from the cameras on the outside mirrors, the front and the rear of the vehicle.

4-8 Display screen, heater and air conditioner, and audio system



- Tall objects, such as a kerb or vehicle, may be misaligned or not displayed at the seam of the views.
- Objects that are above the camera cannot be displayed.
- The view for the bird's-eye view may be misaligned when the camera position alters.
- A line on the ground may be misaligned and is not seen as being straight at the seam of the views. The misalignment will increase as the line proceeds away from the vehicle.

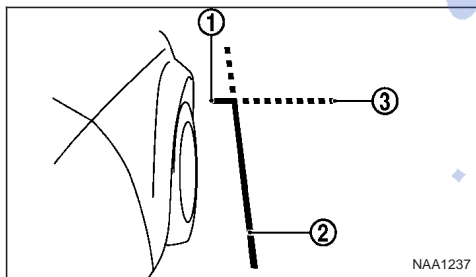

Front-side view, Left-Hand Drive (LHD) models*

*: For the Right-Hand Drive (RHD) models, the screen layout will be opposite.

Front-side view

CAUTION

The actual distance to objects may differ from the distance shown.

Guiding lines:

Guiding lines that indicate the approximate width and the front end of the vehicle are displayed on the monitor.

The front-of-vehicle line ① shows the front part of the vehicle.

The side-of-vehicle line ② shows the vehicle width including the outside mirror.

The extensions ③ of both the front ① and side ② lines are shown with a green dotted line.

DIFFERENCE BETWEEN PREDICTIVE AND ACTUAL DISTANCES

The distance guide line and the vehicle width guide line on the front and the rear view should be used as a reference only when the vehicle is on a level, paved surface. The distance viewed on the monitor is for reference only and may be different than the actual distance between the vehicle and displayed objects.

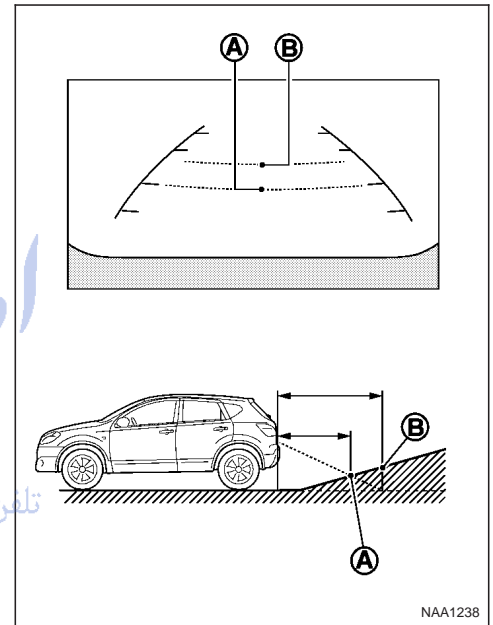

NAA1238

Moving to a steep uphill

When moving the vehicle up a hill, the distance guide lines and the vehicle width guide lines are shown closer than the actual distance. For example, the display shows 1 m (3 ft) to the place (A), but the actual 1 m (3 ft) distance on the hill is the place (B). Note that any object on the hill is viewed in the monitor further than it appears.

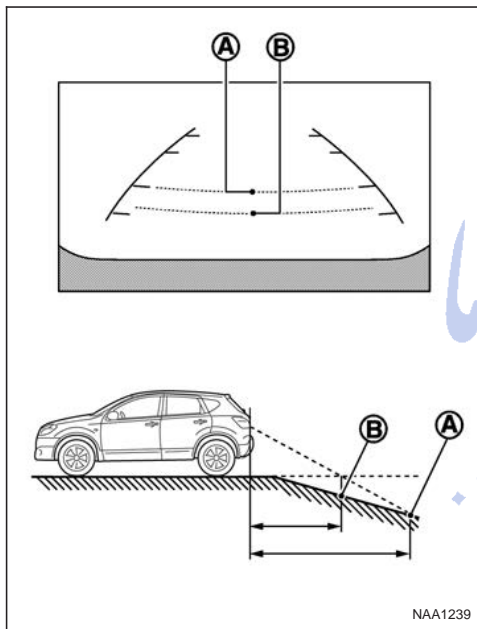

NAA1239

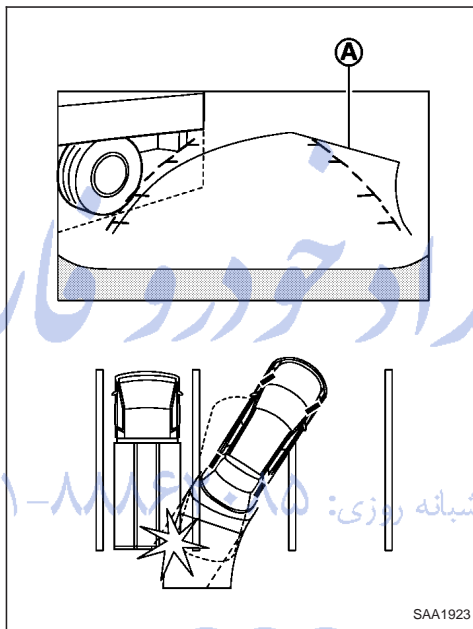

SAA1923

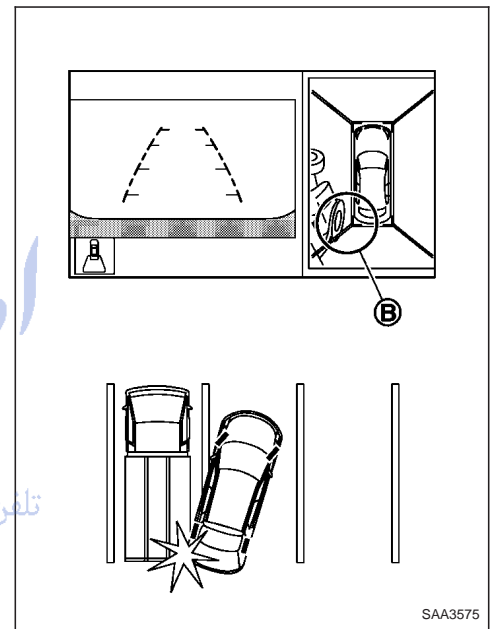

SAA3575

Moving to a steep downhill

When moving the vehicle down a hill, the distance guide lines and the vehicle width guide lines are shown further than the actual distance. For example, the display shows 1 m (3 ft) to the place (A), but the actual 1 m (3 ft) distance on the hill is the place (B). Note that any object on the hill is viewed in the monitor closer than it appears.

Moving near a projecting object

The predictive course lines (A) do not touch the object in the display. However, the vehicle may hit the object if it projects over the actual moving course.

There may be a small visible distance between the vehicle and the object in the bird's-eye view (B) on the monitor. However, the actual distance may be smaller than displayed and the vehicle may hit the object.

4-10 Display screen, heater and air conditioner, and audio system



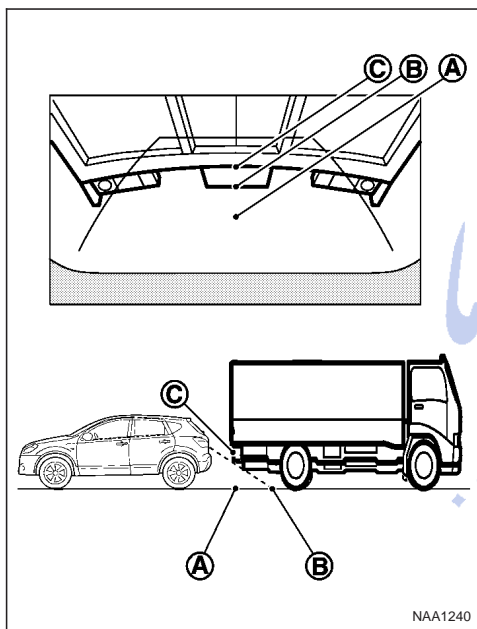

HOW TO ADJUST THE SCREEN VIEW

To adjust the display brightness of the Around View Monitor, use the settings described in the separately provided NISSAN Connect owner's manual.

Do not adjust the settings while the vehicle is moving. Make sure the handbrake is firmly applied.

OPERATING TIPS

- The screen displayed on the Around View Monitor will automatically return to the previous screen 3 minutes after the <CAMERA> button has been pushed while the gear selector lever is in a position other than the R (Reverse) position.
- The display of images on the screen may be delayed after screens are switched. Objects in the Around View Monitor may be distorted momentarily until the Around View Monitor screen is displayed completely.
- When the temperature is extremely high or low, the screen may not display objects clearly. This is not a malfunction.
- When strong light directly shines on the camera, objects may not be displayed clearly. This is not a malfunction.
- Vertical lines may be seen in objects on the screen due to light reflections. This is not a malfunction.
- The screen may flicker under fluorescent light. This is not a malfunction.

- The colours of objects on the Around View Monitor may differ somewhat from those of the actual object.
- Objects on the monitor may not be clear and the colour of the object may differ in a dark location or at night. This is not a malfunction.
- There may be differences in clearness between each camera view of the bird's-eye view.
- If dirt, rain or snow attaches to the camera, the Around View Monitor may not display objects clearly. Clean the camera.

CAUTION

Do not scratch lenses when cleaning the camera.

- Do not use alcohol, benzene or thinner to clean the camera. This will cause discolouration. To clean the camera, wipe with a cloth that has been dampened with a diluted mild cleaning agent and then wipe with a dry cloth.
- Do not damage the camera because the monitor screen may be adversely affected.
- Do not use wax on the camera window. Wipe off any wax with a clean cloth that has been dampened with a mild detergent diluted with water.

Moving closer to a projecting object

The position © is shown further than the position © in the display. However, the position © is actually at the same distance as the position ©. The vehicle may hit the object when moving toward the position © if the object projects over the actual moving course.

VENTS

SIDE AND CENTRE VENTS

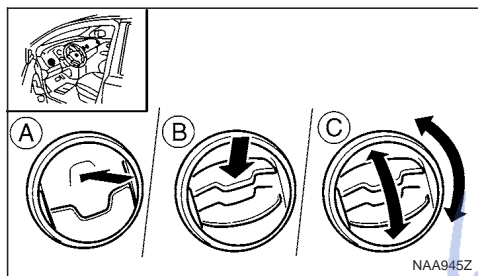

The direction of the air flow can be adjusted by (A) opening, (B) closing or (C) adjusting.

HIGH LEVEL VENT (where fitted)

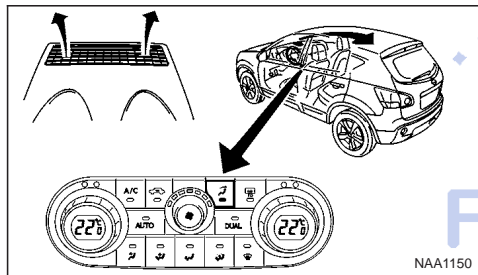

Press the  button to switch the mild air flow from the upper vent on or off. Use the upper vent on hot days to let cool air flow along the roof to the rear passengers; and on cold days to improve the defrosting or defogging of the windows with warm air.

HEATER AND AIR CONDITIONER OPERATION



WARNING

- Do not leave children or adults who would normally require the support of others alone in your vehicle. Pets should not be left alone either. On hot, sunny days, temperatures in a closed vehicle could quickly become high enough to cause severe or possibly fatal injuries to people or animals.
- Do not use the recirculation mode for long periods as it may cause the interior air to become stale and the windows to fog up. It is recommended that you use the outside air mode in cold weather to keep the windows clear.
- Do not adjust the positioning of the heating/ventilation or air conditioning controls while driving.

NOTE

- Condensation forms inside the air conditioning unit when the air conditioner is running, and is safely discharged underneath your vehicle.

Traces of water on the ground are therefore normal.

- Models with Stop/Start System:

Whilst the engine is stopped by the Stop/Start System, selecting airflow to the front defogger or switching on the rear defogger will cause the engine to be automatically restarted.

Whilst the engine is running, selecting airflow to the front defogger or switching on the rear defogger will prevent the Stop/Start System automatically stopping the engine.

The Stop/Start System will prevent unnecessary fuel consumption and exhaust emissions. When the engine is stopped by the Stop/Start System heater and air conditioner performance may be reduced. To keep full heater and air conditioner performance, restart the engine by pressing the Stop/Start System OFF switch, or by turning the ignition switch.

For more information on the Stop/Start System, see "Stop/Start System (where fitted)" in the "5. Starting and driving" section.

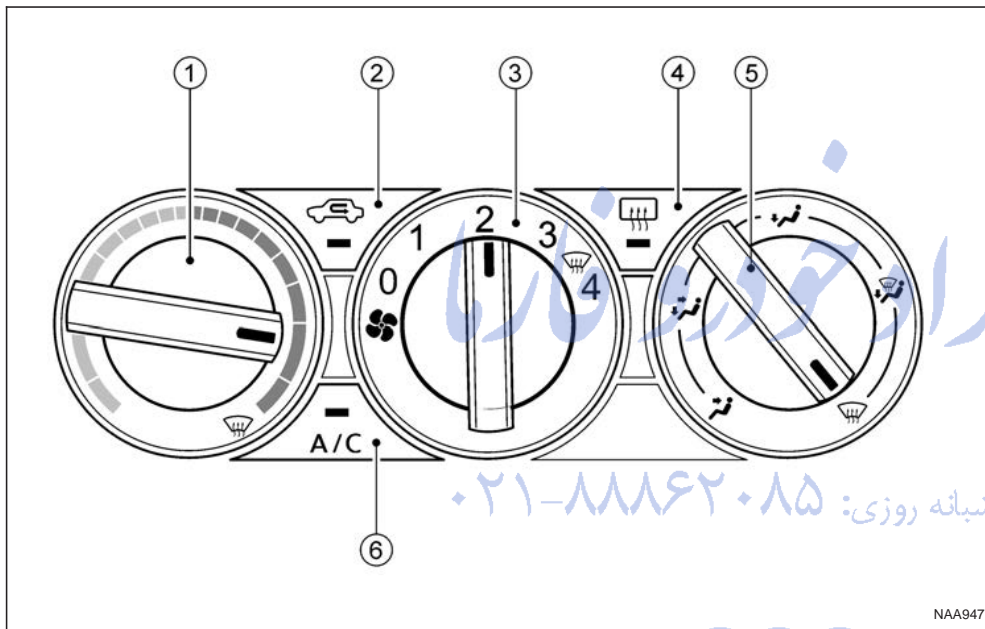

Manual air conditioner

MANUAL AIR CONDITIONER

- ① Temperature control dial
- ② Air recirculation button
- ③ Fan speed control dial
- ④ Rear window defogger button

(For details, see "Defogger switch" in the

- ⑤ Airflow control dial
- ⑥ Air conditioner ON/OFF button

Controls

Fan speed control dial  :





To switch the fan on or off and to control the fan speed, turn the fan speed control dial clockwise to increase the fan speed. To decrease the fan speed, turn the fan speed control dial anticlockwise.

Temperature control dial:

Turn the temperature control dial to set the desired air temperature from the vents and floor outlets.

Air flow control dial:

Use this dial to manually select the air flow from the air outlets as described below.

-  : Air flows from centre and side vents.
-  : Air flows from centre, side vents and floor outlets.
-  : Air flows mainly from floor outlets.
-  : Air flows from the defogger outlets and floor outlets.
-  : Air flows mainly from defogger outlets.

Air recirculation button  :

Outside air circulation

- Press the air recirculation () button to the "OFF" position to draw outside air into the passenger compartment (the indicator light goes off). Use the "OFF" position for normal heating ventilation, or air conditioner (where fitted) operation.

● Air recirculation

Press the air recirculation () button to the "ON" position (the indicator light goes on). Use the "ON" position in situations such as: driving on a dust raised road, avoiding traffic fumes or having maximum cooling from the air conditioner (where fitted).

If the windows fog up, switch on the air conditioning (where fitted).

A/C (Air Conditioner) button (where fitted):









Press the A/C button to turn the air conditioner on or off. When the air conditioner is on, the A/C indicator light illuminates.

Operation



The heater and air conditioner operate when the engine is running. The air blower will operate even if the engine is turned off and the ignition switch is in the ON position.

NOTE

The air conditioner cooling function operates only when the engine is running and the fan is activated.

1. Press the air recirculation () button to the "OFF" position.
2. Turn the airflow control dial for:
 - **Cooling:** select the  or  position.
 - **Heating:** select the  or  position.
 - **Heating and defogging:** select the  position.
 - **Ventilation:** select the  or  position.
 - **Windscreen defogging:** select the  position
3. Turn the fan speed control dial to the desired position.
4. Turn the temperature control dial to the desired position.

NOTE



When selecting the  or  position, turn the temperature control dial to the desired position between the middle and the maximum "HOT" (right) position.

5. Press the A/C button (where fitted) to the "ON" position and the indicator light will come on. Switch this mode on for dehumidified heating or cooling.

NOTE

- The air conditioner mode is used to cool and dehumidify. For quick cooling when the outside temperature is high, select the air recirculation mode position (). Be sure to return to the outside air mode to avoid windows from fogging-up and interior air from becoming stale.

A visible mist may be seen coming from the vents in hot, humid conditions as the air is cooled rapidly this is not a malfunction.

- For quick heating, press the air recirculation () button to the "ON" position. Be sure to return to the "OFF" position for normal heating (no indicator light) in order to avoid window fog and stale interior.
- To quickly defrost/defog the windscreen, turn:
 - 1) The airflow control dial to  position.
 - 2) The fan speed control dial to speed position 4.

4-14 Display screen, heater and air conditioner, and audio system

3) The temperature control dial to the maximum "HOT" (right) position.

NOTE

The air recirculation mode should not be selected for either heating or defrosting.

Operating tips

- In order to improve the heater operation, clear the snow and ice from the wiper blade and air inlet in front of the windscreen.
- After parking in the sun, drive for two or three minutes with the windows open to vent hot air from the passenger compartment. Then close the windows to allow the acceleration of the air conditioner's cooling operation.
- Keep the windows closed while the air conditioner is operating.
- The air conditioning system should be operated for about 10 minutes, at least once a month. This helps prevent damage to the system due to lack of lubrication.
- If the coolant temperature gauge exceeds the "HOT" position, turn the air conditioner off. For additional information, see "Engine overheat" in the "6. In case of emergency" section.
- If the engine coolant reaches an extremely high temperature, the air conditioning system will automatically turn off. This may happen for example if the engine runs at idle speed for a long time on a hot day.

امداد خودرو فارما

تلفن شبانه روزی: ۰۲۱-۸۸۶۲۰۸۵

FarmaSOS.com

Quick reference charts

The following charts show the button, air intake and dial positions for **MAXIMUM AND QUICK** heating, cooling or defrosting.

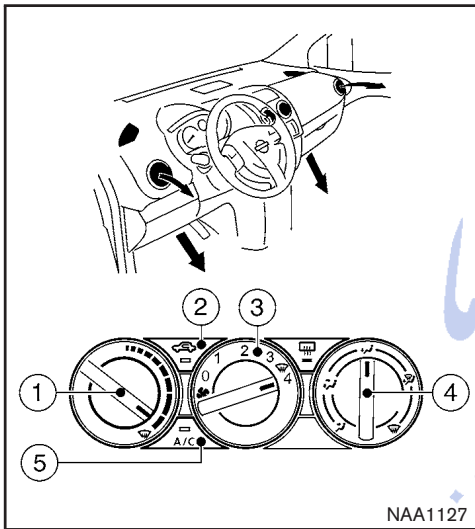

NAA1127

HEATING

Controls		Settings
①	Temperature control dial	HOT
②	Air recirculation button	OFF
③	Fan speed control dial	4
④	Air flow control dial	
⑤	Air conditioner button (where fitted)	OFF

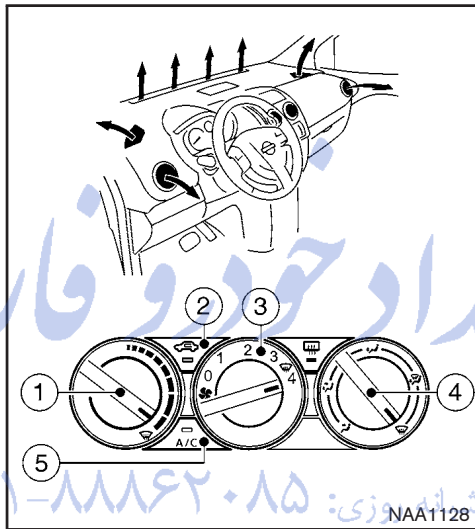

NAA1128

DEFROSTING/DEFOGGING

Controls		Settings
①	Temperature control dial	HOT
②	Air recirculation button	OFF
③	Fan speed control dial	4
④	Air flow control dial	
⑤	Air conditioner button (where fitted)	ON

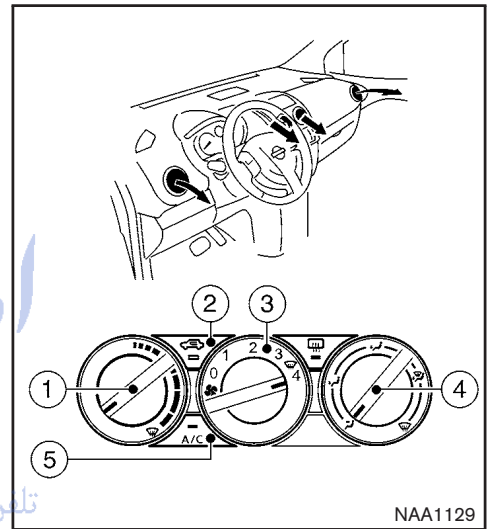

NAA1129

COOLING

Controls		Settings
①	Temperature control dial	COLD
②	Air recirculation button	ON (Max)
②	Air recirculation button	OFF (Normal)
③	Fan speed control dial	4
④	Air flow control dial	
⑤	Air conditioner button (where fitted)	ON

4-16 Display screen, heater and air conditioner, and audio system



Air conditioner filter (where fitted)

The air conditioning system is equipped with a filter which collects dirt, pollen, dust, etc. To make sure the air conditioner heats, defogs, and ventilates efficiently, replace the filter regularly. For filter replacement, contact a NISSAN dealer or qualified workshop.

The filter should be replaced if the airflow is extremely reduced or when the windows fog up easily during air conditioning system operation.

Servicing air conditioner

The air conditioning system (where fitted) in your NISSAN vehicle is charged with an environmentally friendly refrigerant.

 NISSAN GREEN PROGRAM

This refrigerant will not harm the earth's ozone layer.

Special charging equipment and lubricant are required when servicing your vehicle's air conditioner. Using improper refrigerants or lubricants will cause severe damage to the air conditioning system. See "Air conditioning system refrigerant and lubricant recommendations (where fitted)" in the "9. Technical information" section of this manual.

A NISSAN dealer or qualified workshop will be able to service the air conditioning system.

امداد خودرو فارما

تلفن شبانه روزی: ۰۸۵-۸۸۸۶۲۰۲۱

ArmaSOS.com

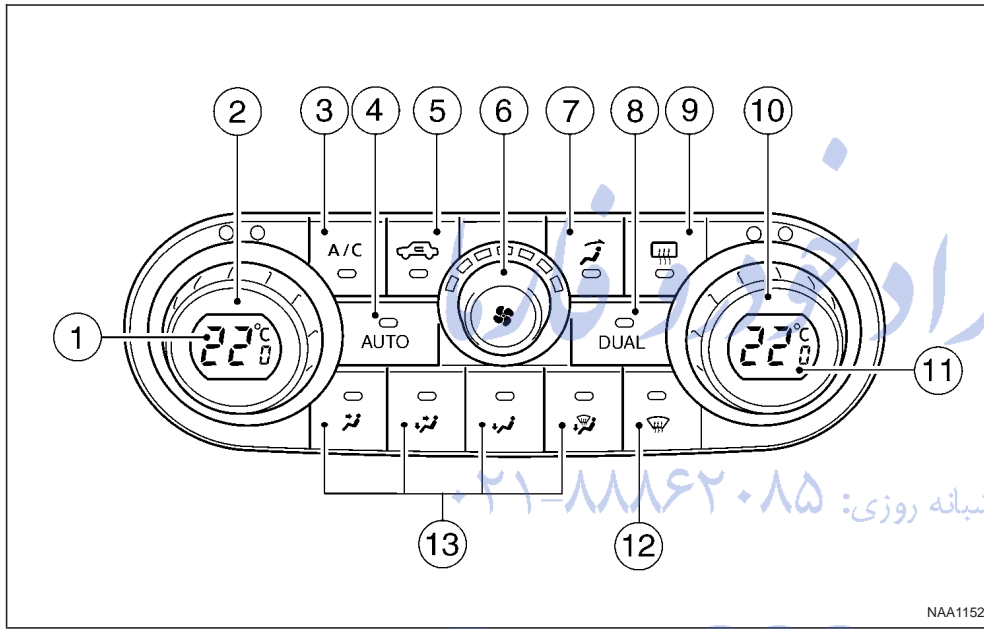

Automatic air conditioner (where fitted)

AUTOMATIC AIR CONDITIONER (where fitted)

- ① Temperature display
- ② Temperature control dial (Driver's side (LHD)/ Passenger's side (RHD))
- ③ Air conditioner ON/OFF button

- ④ AUTO (climate control button)
- ⑤ Air recirculation button
- ⑥ Fan speed control dial
- ⑦ High level vent button
ON/OFF button (press)
For details, see "Vents" earlier in this section.

- ⑧ DUAL zone control ON/OFF button
- ⑨ Rear window defogger button (and outside mirror defogger (For details, see "Defogger switch" in the "2. Instruments and controls" section))
- ⑩ Temperature control dial (Driver's side (RHD)/ Passenger's side (LHD))
- ⑪ Temperature display
- ⑫ Windscreen defogger button
- ⑬ Air flow mode buttons

⚠ WARNING

- Do not leave children or adults who would normally require the support of others alone in your vehicle. Pets should not be left alone either. On hot, sunny days, temperatures in a closed vehicle could quickly become high enough to cause severe or possibly fatal injuries to people or animals.
- Do not use the recirculation mode for long periods as it may cause the interior air to become stale and the windows to fog up. It is recommended that you use the outside air mode in cold weather to keep the windows clear.
- Do not adjust the positioning of the heating/ventilation or air conditioning controls while driving.

4-18 Display screen, heater and air conditioner, and audio system



NOTE

- The air conditioner cooling function operates only when the engine is running, and the ambient temperature is above -2°C (28°F).
- The air conditioner can be used to dehumidify when heating, or to reduce air temperature and dehumidify when cooling. This is possible in both auto or manual control mode as long as the fan speed is minimum (first bar).
- When the AUTO mode is selected, the temperature of the passenger compartment will be maintained automatically. Air flow distribution and fan speed will also be controlled automatically.

Controls

NOTE

Before any selection or change is made, press the AUTO button to activate the heater and air conditioner system.

Cooling and/or dehumidified heating (AUTO mode):

This mode may be used all year round. The system works automatically to control the inside temperature, air flow distribution and fan speed after the preferred temperature is set manually.

1. Press the AUTO button (the indicator light will illuminate).
2. Operate the driver's side temperature control dial to set the desired temperature.

Adjust the temperature to about 22°C (72°F) for normal operation.

3. Driver's side and passenger side temperatures can be set independently using the individual temperature control dial. When the passenger side temperature control dial is turned, the DUAL indicator light will come on. To turn off the passenger side temperature control, press the DUAL button.

NOTE

- A visible mist may be seen coming from the vents in hot, humid conditions as the air is cooled rapidly, this is not a malfunction.
- It is not possible to use DUAL mode when windscreen defogger is selected.

Heating (AUTO mode):

Use this mode for heating purposes only.

1. Press the A/C button to turn off the air conditioner cooling function (A/C indicator light goes off).
 2. Select the desired temperature with the temperature control dial.
- Do not set the temperature at a lower level than the one of the outside air temperature. Otherwise the system may not work properly.
 - This mode is not recommended if the windscreen fogs up.

Airflow direction control buttons:

- ☰ : Air flows from centre and side vents.
- ☰☷ : Air flows from centre and side vents and floor outlets.
- ☷ : Air flows mainly from floor outlets.
- ☷☰ : Air flows from defogger and floor outlets.
- ☷☷ : Air flows mainly from defogger outlets.

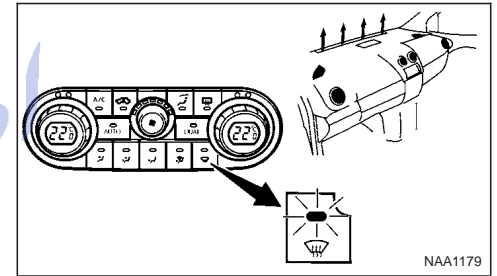

Windscreen defogger (Manual mode):

Use this mode for defogging the windscreen as follows:

1. Press the ☷☷ button.

The system will automatically control the fan speed. In cold conditions the fan will automatically go to maximum speed. The outside air mode (☰☷), the airflow mode (☷☷), and the air conditioner are activated automatically. Air flows mainly from the defogger outlets.

2. To switch off, press either the  button to return to the previous mode or the AUTO button for the auto climate control mode.

- To quickly defrost/defog the windshield, set the fan speed to the maximum position.
- As soon as possible after the windshield has been cleared of ice or fog, press either the windshield defogger button or AUTO button.
- When the windshield defogging mode is activated, the air conditioner will automatically switch on at outside temperatures [above -2°C (28°F)] and the air recirculation mode will be switched off.
- Outside air is drawn into the passenger compartment to improve the defogging performance.

Heating and defogging (Manual mode):

This mode heats the interior and defogs the windshield.

The outside air is drawn inside the passenger compartment when the  button is pressed. Switch on the air-conditioning to improve the defogging and adjust the preferred fan speed and temperature.

Fan speed control (Manual mode):

Turn the fan speed control dial anticlockwise or clockwise to adjust the fan speed.

Press the AUTO button to change the fan speed to automatic mode.

Air recirculation:



Use this mode to recirculate interior air inside the passenger compartment in situations such as driving on a dust raised road, avoiding traffic fumes or having maximum cooling from the air conditioner.

Press the  button to recirculate interior air. The indicator light illuminates and the air conditioner will automatically come on.

When the air recirculation mode is switched off, outside air is drawn into the passenger compartment.

Outside air circulation:

Use this mode to draw outside air into the passenger compartment for normal heating, ventilation or air conditioner operation.

Press the  button to change the air intake from the air recirculation to the outside air mode. The indicator light  turns off.

To turn the system on/off:

Press the "ON/OFF"  button to turn the system on or off.

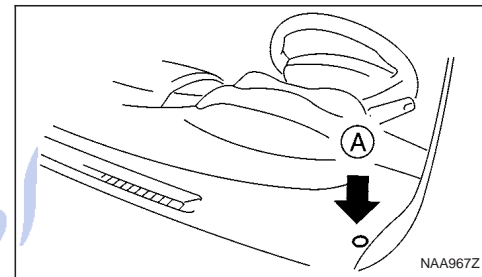

The sensor (A) (next to the tweeter speaker) helps the air conditioning system to maintain a constant cabin temperature. Do not put anything on or around this sensor and ensure that items nearby on the windshield do not shade it.

Operating tips

- In order to improve the heater operation, clear the snow and ice from the wiper blade and air inlet in front of the windshield.
- When the engine coolant temperature and outside air temperature are low, the airflow from the floor outlets may not operate for a maximum of 150 seconds. However, this is not a malfunction. After the coolant temperature has warmed up, the airflow from the floor outlets will operate normally.

- After parking in the sun, drive for two or three minutes with the windows open to vent hot air from the passenger compartment. Then, close the windows. This will allow the acceleration of the air conditioner's cooling operation.
- Keep windows closed while the air conditioner is operating.
- The air conditioning system should be operated for about 10 minutes, at least once a month. This helps prevent damage to the system due to lack of lubrication.
- If the coolant temperature gauge exceeds the "HOT" position, turn the air conditioner off. For additional information, see "Engine overheat" in the "6. In case of emergency" section.
- If the engine coolant reaches an extremely high temperature, the air conditioning system will automatically turn off. This may happen for example if the engine runs at idle speed for a long time on a hot day.

Air conditioner filter

The air conditioning system is equipped with a filter which collects dirt, pollen, dust, etc. To make sure the air conditioner heats, defogs, and ventilates efficiently, replace the filter regularly. To replace the filter, contact a NISSAN dealer or qualified workshop.

The filter should be replaced if the airflow is extremely reduced or when the windows fog up easily while operating the heater or air conditioning system.

Servicing air conditioner

The air conditioning system in your NISSAN vehicle is charged with an environmentally friendly refrigerant.

NISSAN GREEN PROGRAM

This refrigerant will not harm the earth's ozone layer.

Special charging equipment and lubricant are required when servicing the NISSAN air conditioner. Using improper refrigerants or lubricants will cause severe damage to the air conditioning system. See "Air conditioning system refrigerant and lubricant recommendations (where fitted)" in the "9. Technical information" section.

A NISSAN dealer or qualified workshop will be able to service the air conditioning system.

AUDIO SYSTEM

WARNING

Do not adjust the audio system while driving.

The audio system operates when the ignition switch is in the Acc or ON position. If you want to listen to the radio or CD while the engine is not running, turn the ignition switch to the Acc position. **Do not use for an extended period of time with the engine stopped.**

AUDIO OPERATION PRECAUTIONS

NOTE

Models with NISSAN Connect system, see the audio operation precautions in the separately provided NISSAN Connect Owner's Manual.

Radio

- Radio reception is affected by station signal strength, distance from radio transmitter, buildings, bridges, mountains and other external influences. Intermittent changes in reception quality are normally caused by these external influences.
- Using a mobile phone in or near the vehicle may influence radio reception quality.
- Use the antenna for the best reception.

Compact Disc (CD) player

- **During cold weather or rainy days, the player may malfunction due to the humidity. If this occurs, remove the CD and dehumidify or ventilate the player completely.**

- The player may skip while driving on rough roads.
- Occasionally, the CD player may not function when the compartment temperature is extremely high. Decrease the temperature before use.
- Do not expose the CD to direct sunlight.
- CDs that are of poor quality, dirty, scratched, covered with finger prints, or that have pin holes may not work properly.
- The following CDs may not work properly.
 - Copy control compact discs (CCCD)
 - Recordable compact discs (CD-R)
 - Rewritable compact discs (CD-RW)
- Do not use the following CDs as they may cause the CD player to malfunction.
 - 8 cm (3.1 in) discs with an adaptor
 - CDs that are not round
 - CDs with a paper label

ANTENNA

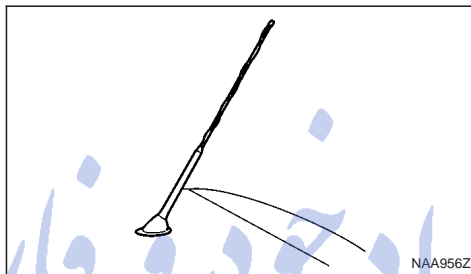

Removing the antenna

To remove the antenna, hold the lower part of the antenna and turn it anticlockwise.

CAUTION

Make sure to remove the antenna before the vehicle enters a garage with a low ceiling or an automatic car wash otherwise the antenna can be damaged.

FarmaSOS.com



LW-MW-FM RADIO WITH CD PLAYER OR 6 CD CHANGER

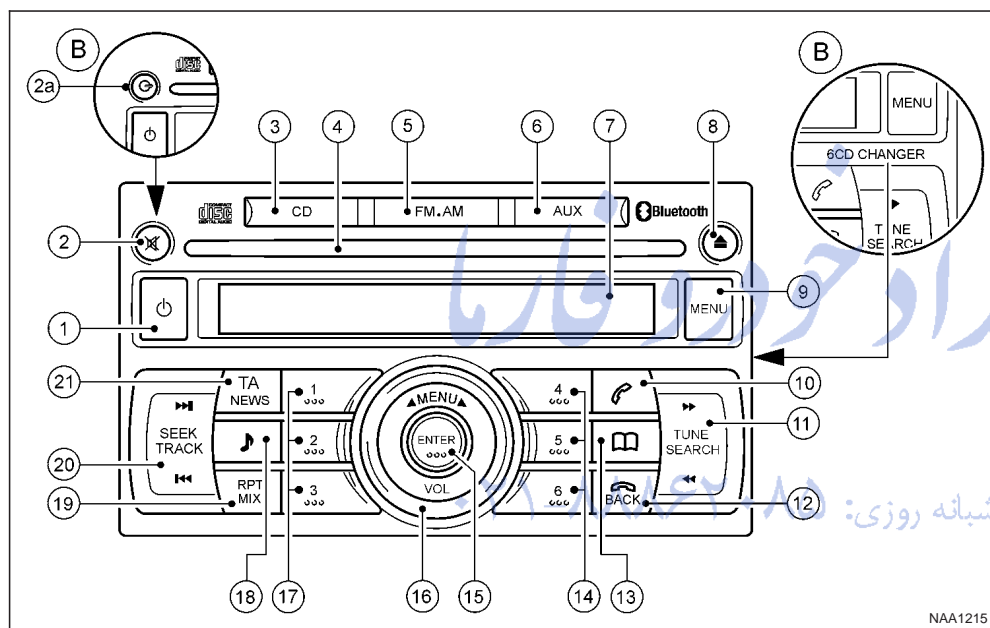

– Type A: CD player

– Type B: 6 CD changer

- ① Power ON/OFF button
- ② CD player: MUTE button
- ②a 6 CD changer: CD Load button
- ③ CD play mode button

- ④ CD slot
- ⑤ FM•AM button
- ⑥ AUX button
- ⑦ Display
- ⑧ CD EJECT button
- ⑨ MENU button

- ⑩ Telephone button
- ⑪ Radio mode: Manual tune buttons
CD mode: Fast forward (Cue)/Fast reverse (Review) buttons
- ⑫ Phone disconnect/BACK button
- ⑬ Phone book button
- ⑭ CD player: Preset station buttons
6 CD changer:
Radio mode: Preset station buttons
CD mode: CD select buttons
- ⑮ ENTER (Confirmation) button
- ⑯ Volume control/Menu adjustment dial
- ⑰ CD player: Preset station buttons
6 CD changer:
Radio mode: Preset station buttons
CD mode: CD select buttons
- ⑱ Sound preference button
- ⑲ RPT (Repeat)/MIX (Random) button
- ⑳ Radio mode: Seek tuning buttons
CD mode: Track Up/Down buttons
- ㉑ TA (Traffic Announcement)/NEWS button

ANTI-THEFT SYSTEM

The audio unit is uniquely matched to the vehicle's NISSAN Anti Theft System (NATS) and therefore cannot be transferred to any other vehicle. This unit can only be activated when the ignition switch for NATS is in the Acc or ON position.

AUDIO MAIN OPERATION

The audio unit operates when the ignition switch is in Acc or ON position.

Power ON/OFF button

Press the  button to switch on the audio unit. If the audio unit was switched off using the ignition switch, it can also be switched on with the ignition switch. The mode (radio or CD) that was playing immediately before the unit was switched off will resume playing and the volume will be set to the previous volume level.

The audio unit can be switched off either by pressing the  button or by turning the ignition switch to the "OFF" or LOCK position.

Volume level control

Turn the MENU/VOL dial in the clockwise or anticlockwise direction to adjust the volume level.



The audio unit is equipped with a speed control volume function, this means that the audio unit automatically adjusts the volume level in relation to vehicle speed. For details, see "MENU button" later in this section.

Mute button (where fitted)

Press the  button to mute the sound and [MUTE] appears in the display. To cancel the mode, use any one of the following options:

- Press the  button again.
- Turn the MENU/VOL dial.
- Press the <CD>, <FM•AM> or <AUX> button.

Sound button

Press the  button to enter the sound menu. Each time the  button is pressed, the mode will change as follows:

[BASS] → [TREBLE] → [BALANCE] → [FADE] → [EQ] → [BASS]

When the desired mode appears in the display, turn the MENU/VOL dial clockwise or anticlockwise to adjust the settings. When the configuration is complete, press the <ENTER> button repeatedly or the <BACK> button once until the sound menu screen is exited or wait at least 5 seconds without pressing any buttons.

BASS control

Use this control to enhance or attenuate bass response sound.

Turn the MENU/VOL dial clockwise or anticlockwise to adjust the bass settings.

TREBLE control

Use this control to enhance or attenuate the treble.

Turn the MENU/VOL dial clockwise or anticlockwise to adjust the treble settings.

BALANCE control

Use this control to adjust the balance of the volume between the left and right speakers.

Turn the MENU/VOL dial anticlockwise or clockwise to adjust the left/right balance.

FADE (Fader) control

Use this control to adjust the balance of the volume between the front and rear (where fitted) speakers.

Turn the MENU/VOL dial anticlockwise or clockwise to adjust the front/rear balance.

EQ (Equalizer)

Use this control to change the preset sound mode.

Turn the MENU/VOL dial in the clockwise or anticlockwise direction and the mode will change as follows:

[OFF] ↔ [ENHANCE] ↔ [ACOUSTIC] ↔ [LIVE] ↔ [OFF]

RADIO OPERATION

When the  (Power) button is pressed, the audio unit will switch on with the last received radio station, if the audio unit was previously switched off in radio mode.



FM•AM Band select button

Press the <FM•AM> button to change the reception wave band as follows:

FM1 → FM 2 → FM T → MW → LW → FM1

When <FM•AM> button is pressed while the ignition switch is in the Acc or ON position, the radio will come on at the last received radio station. If the CD is already playing, pressing the <FM•AM> button will switch off the CD play mode and the last received radio station will be selected.

FM Auto store

When the <FM•AM> button is pressed for more than 1.5 seconds and the six strongest stations are stored in the preset (1 to 6) of the FM T band. During the search, a notification message [AUTOSTORE] appears in the display and the sound is muted until the operation is complete. Once completed, the radio selects preset 1.



Manual tuning buttons



WARNING

The radio should not be tuned while driving in order for full attention to be given to the driving operation.

Press the ►► or ◀◀ button repeatedly to increase or decrease the frequency.

The frequency increases or decreases in steps of 100 kHz on the FM band, 9kHz on the MW band, and 3 kHz on the LW band.

If the ►► or ◀◀ button is held down with a long press, the frequency will continuously increase or decrease until the button is released.



SEEK tuning buttons

Pressing briefly on the ►► or ◀◀ button starts the tuning mode. The radio tuner seeks from low to high or high to low frequencies and stops at the next broadcasting station. During seek mode, the audio output is muted. If no broadcasting station can be found within the complete band cycle, it will return to the initial frequency.

If the ►► or ◀◀ button is held down with a long press, the seek mode will continuously increase or decrease until the button is released. When the button is released, the seek mode will seek the next broadcasting station.

Preset station buttons ①②③④⑤⑥

Pressing a preset button for less than 2 seconds will select the stored radio station.

Pressing a preset button for more than 2 seconds will cause the station currently being received to be stored against that preset button.

- Eighteen stations can be stored in the FM band. (Six each for FM1, FM2 and FMT)
- Six stations can be set for both the MW and LW bands.

If the battery is disconnected, or if the fuse blows, the radio memory will be erased. In that case, reset the desired stations after battery connection or fuse replacement.

Radio data system (RDS) operation

The RDS is a system through which encoded digital information is transmitted by FM radio station in addition to the normal FM-radio broadcasting. The RDS provides information services such as station name, traffic information and news.

NOTE

In some countries or regions, some of these services may not be available.

Alternative Frequency (AF) mode:

The AF mode operates in the FM (radio) mode.

- The AF mode operates both in the FM (radio) and CD mode (if FM was previously selected in the radio mode).
- When AF mode has been set to the "ON" position in the user set up menu mode, the [AF] indicator comes on. For activation or deactivation details, see "MENU button" later in this section.

The AF function compares signal strengths and selects the station with the optimum reception conditions for the currently tuned-in station.

RDS functions

Programme Service (PS) function (station name display function):

When an RDS station is tuned in with seek or manual tuning, the RDS data is received and the PS name is displayed.

Emergency broadcast interrupt function (ALARM INTERRUPTION - EBU SPEC FOR INFO):

When the radio receives PTY code 31 (an emergency broadcast code), the sound is interrupted, the emergency broadcast is heard, and [ALARM] is displayed. The volume level at this time is the same as that for traffic announcements. Once the emergency broadcast is finished, the unit immediately returns to the previous source.

REG (Regional) mode:

Some local radio stations are linked according to region because they only offer limited coverage due a limited number of transmitters. If the signal from one station of these stations becomes weak while driving, RDS mode will switch to another local station in the region with a stronger signal.

When the REG mode is activated in the FM band and the radio receiver is tuned to a local radio station, it will keep receiving this radio station without switching to another local station. For activation or deactivation details, see "MENU button" later in this section.

TA Traffic announcement

This function operates in both FM (radio) and CD mode.

- Pressing the <TA NEWS> button selects the TA mode. The TA indicator is displayed while TA mode is on.
- When the <TA NEWS> button is pressed again. The mode will be switched off and the TA indicator will disappear from the display.
- If the TA mode is not activated, a T icon will appear in the display when the currently received radio station is capable of broadcasting traffic announcements. Pressing the <TA NEWS> button will activate TA mode and the indicator will change from T to TA.

Traffic announcement interrupt function:

When a traffic announcement is received, the announcement is tuned in.

Once the traffic announcement has finished, the unit returns to the source that was active before the traffic announcement started. The volume returns to the previous level.

If the <TA NEWS> button is pressed during a traffic announcement, the traffic announcement interrupt mode is cancelled. The TA mode returns to the standby mode and the audio unit returns to the previous source.

NOTE

TA mode operates regardless of whether the AF mode is on or off.

NEWS mode

When the NEWS mode is activated and the radio receives a NEWS code from a FM broadcasting station, the playing mode will be interrupted. Once the news broadcast has finished, the audio unit will return to the previous source. During the interruption, NEWS and the broadcasting station name will be displayed.

To enable or disable the NEWS mode, press the <TA NEWS> button for more than 2 seconds. When the NEWS mode is enabled, the NEWS icon will be displayed.

1. NEWS standby mode

- The NEWS standby mode can be activated while in FM or CD mode.
- Pressing the TA NEWS button for more than 2 seconds, the NEWS standby mode will switch off and the NEWS icon will disappear from the display.

2. NEWS interruption mode

- Pressing the <TA NEWS> button for more than 2 seconds, the NEWS standby mode will switch off and the NEWS icon will disappear from the display.



- When the <CD> or <AUX> button is pressed during a NEWS interruption, the NEWS standby mode remains active.

However, if the <FM•AM> button is pressed and the radio wave band changes to the MW or LW, then the NEWS standby mode will be switched off.

MENU BUTTON

To configure Alternative Frequency (AF), Regional (REG) and Language settings, perform the following procedure:

- 1) Press and hold the <MENU> button for at least 1.5 seconds.
 - 2) Turn the MENU/VOL dial clockwise or anticlockwise, the display message will appear in the following order:
[AF] ⇔ [REG] ⇔ [LANGUAGE] ⇔ [AF]
- To activate or deactivate the AF and REG mode, briefly press the <ENTER> button when [AF] or [REG] appears in the display and turn the MENU/VOL dial clockwise or anticlockwise to switch between the on or off position. After selection, press the <ENTER> button to save the settings.
 - When the AF mode is enabled, the audio unit will automatically re-tune to a stronger frequency if the radio signal becomes weak.
 - When the REG mode is enabled, the audio unit will maintain and hold the station which is broadcasting local (regional) programmes.

- To change the display language, briefly press on the <ENTER> button when LANGUAGE appears in the display then turn the MENU/VOL dial clockwise or anticlockwise to select the appropriate language setting.

[ENGLISH] ⇔ [DUTCH] ⇔ [FRENCH] ⇔ [SPANISH] ⇔ [GERMAN] ⇔ [ITALIAN] ⇔ [PORTUGUESE] ⇔ [ENGLISH]

After selecting the desired language, press the <ENTER> button to save the setting.

- After the desired levels have been set, press either the <MENU> button for at least 1.5 seconds, the <BACK> button, or wait for 5 seconds without pressing any buttons to exit the menu screen.

To configure the [SPEED VOL] (Volume) and [BEEP] settings, perform the following procedure:

- 1) Briefly press the <MENU> button.
 - 2) Turn the MENU/VOL dial clockwise or anticlockwise, the display message will appear in the following order:
[PHONE SETUP] ⇔ [SPEED VOL] ⇔ [BEEP] ⇔ [PHONE SETUP]
- When [SPEED VOL] is displayed, briefly press the <ENTER> button then turn the MENU/VOL dial clockwise or anticlockwise to adjust the level of the volume.
Adjusting the setting to 0 (zero) turns off the speed volume feature. Increasing the speed volume setting results in the audio volume increas-

ing more rapidly with vehicle speed. Press the <ENTER> button again to save the setting.

- When [BEEP] appears in the display, briefly press the <ENTER> button and then turn the MENU/VOL dial clockwise or anticlockwise to switch the beep sound on or off. When this item is turned on, you will hear a beep sound when you use a button. Press the <ENTER> button again to save the setting.

After the desired levels have been set, press either the <MENU> button, the <BACK> button, or wait for 10 seconds without pressing any buttons to exit the menu screen.

COMPACT DISC (CD) OPERATION

Turn the ignition switch to the Acc or ON position, press the <CD> button and the CD mode will start to play the CD.

When the <CD> button is pressed and the radio mode or AUX mode is already operating, it will automatically turn off and the CD mode will start.

However, if the CD is not loaded, then a notification message will be displayed and the audio unit remains in radio mode or AUX mode.

CAUTION

- Do not force the CD into the slot. This could damage the player.
- Do not use 8 cm (3.1 in) discs.

CD insert (CD player)

Insert the CD into the slot with the label side facing up. The CD will be guided automatically into the slot and will start playing. After loading the CD, the track information will be displayed.

If the radio is already operating, it will be automatically turned off and the CD player will start playing.

CD Play button

Press the <CD> button to start playing the loaded CD. Playing starts from the track that was being played when the CD play mode was switched off.

CD Load button (6 CD Changer)

To insert a CD into the CD changer proceed as follows:

- 1) Press the  button for less than 1.5 seconds
- 2) Select an unoccupied slot by pressing the corresponding CD select button. If no slot is selected, the CD changer will select the first available slot after 5 seconds. If the selected slot is already occupied with a CD then the display will show a notification message that this slot is not available.
- 3) Insert the CD into the slot with the CD label side facing up when the display shows [LOAD CD]. The CD will be guided automatically into the slot and will start playing.

After loading the disc, the track number and the occupied slot number will appear in the display.



If the CD is not loaded within 10 seconds, the CD changer will start to play the last CD or return to the last received radio station.

To insert 6 CDs into the CD changer in succession, press and hold the  button for more than 1.5 seconds.





CD select buttons ①②③④⑤⑥ (6 CD Changer)

To change to another CD stored in the CD changer, press the corresponding CD select button. When a CD is selected, it will start to play from the first track.

Fast Forward (Cue), Fast reverse (Review) buttons

When the  (Cue) or  (Review) button is pressed continuously, the track will be played at high speed. When the button is released, the CD will return to normal playing speed.

Track up/down buttons

Pressing the  or  button once will cause the CD to skip forward or backward to the beginning of the next track. Press the  or  button to skip through the CD tracks. The CD will skip the number of times the button is pressed.

Repeat/MIX button

Pressing the  button repeatedly will change the play mode as follows:

CD player:

[RPT TRACK] → [MIX DISC] → [RPT ALL] → [RPT TRACK]

[RPT TRACK]: The current track will be played continuously.

[MIX DISC]: All the tracks will be played in a random order.

[RPT ALL]: All the tracks will be played in sequential order.

6 CD changer:

[RPT TRACK] → [RPT DISC] → [MIX DISC] → [MIX ALL] → [RPT ALL] → [RPT TRACK]

[RPT TRACK]: The current track will be played continuously.

[RPT DISC]: The currently played CD will be played repeatedly.

[MIX DISC]: All the tracks on the currently played CD will be played in a random order.

[MIX ALL]: All the tracks on all of the CDs will be played in a random order.

[RPT ALL]: All the tracks on all the CDs will be played continuously in sequential order.



 CD eject button

CD player:

Press the eject () button and the CD will be ejected.

6 CD changer:

1. A CD can be ejected by:

- Pressing the eject () button (the currently played CD will be ejected).
- Pressing a CD select button followed by the eject () button.
- Pressing the eject () button followed by a CD select button.

2. After pressing the eject () button, a notification message appears in the display.

3. When the CD slot door opens, the CD is ejected and the CD can now be removed.

4. If necessary, insert another CD into the respective CD slot or wait to let the system close the CD slot door.

To eject all the discs sequentially, press and hold the eject () button for longer than 1.5 seconds. The CD changer will start to eject from the current or last used CD. After removing an ejected CD, the next CD will be ejected.



Ejecting CD (with ignition switch in "OFF" or LOCK):

When the ignition switch is in the "OFF" or LOCK position it is possible to eject the currently played CD. However the audio unit will not be activated.

CD player:

Press the eject () button and the CD will be ejected.

6 CD changer:

- Press the eject () button less than 1.5 seconds and the CD will be ejected.
- To eject all CD's in sequential order, keep the eject () button pressed for longer than 1.5 seconds. The CD changer starts to eject from the current or last used CD onwards. After removing an ejected CD, the next one comes out.

NOTE

- **When the CD is ejected and not removed within 15 seconds, it will automatically retract into the slot to protect it from damage.**
- **If an error message appears in the display, press the eject () button to eject the faulty CD and insert another CD or check if the ejected CD is inserted upside down.**

AUX SOCKET

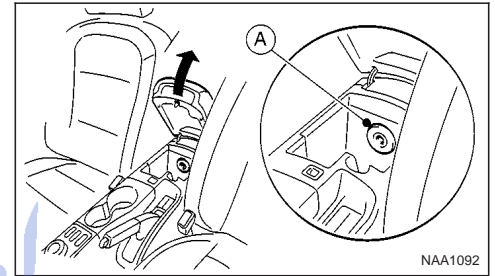

Open the lid and connect the lead with the jack of a compatible player (e.g. MP3 player) to the socket .

Press the <AUX> button for the AUX mode.

BLUETOOTH® MOBILE PHONE FEATURE

This system offers a hands-free facility for your mobile telephone with Bluetooth® to enhance driving comfort.

For details, see "Mobile phone integration for LW-MW-FM radio with CD player or 6 CD changer (Type A)" later in this section.

FM AM RADIO WITH CD PLAYER

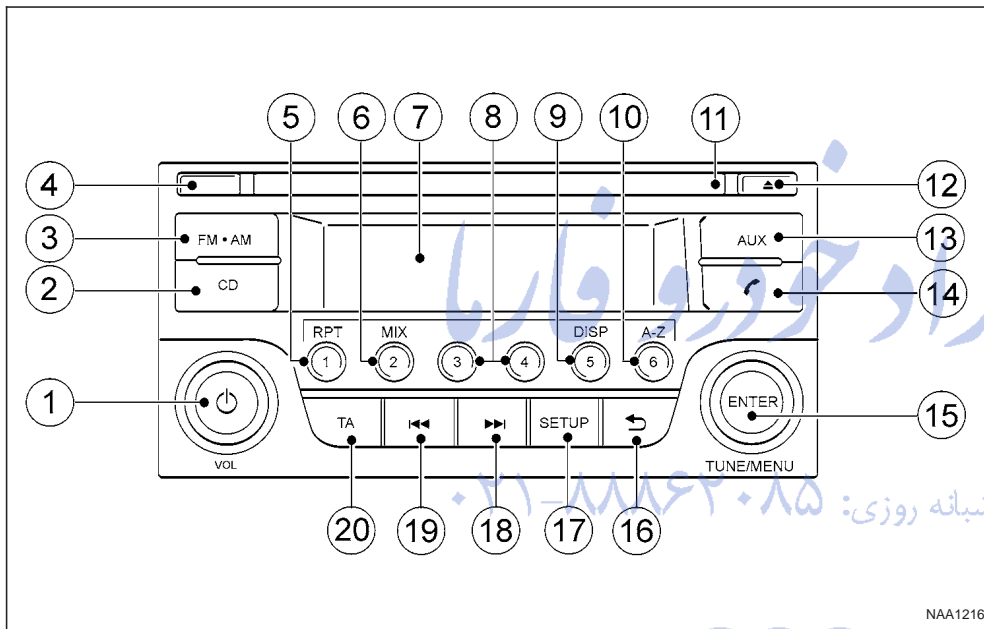

- | | |
|--|-------------------------------|
| 1. Power ON-OFF button/Volume control (VOL) knob | CD mode: Repeat (RPT) button |
| 2. CD play mode button | 6. Radio mode: Preset button |
| 3. FM•AM button | CD mode: MIX button |
| 4. Mute button (where fitted) or ☀/🌙 (Day/Night) button (where fitted) | 7. Display |
| 5. Radio mode: Preset button | 8. Radio mode: Preset buttons |
| | 9. Radio mode: Preset button |

- | | |
|---|--|
| | Audio unit mode: Display (DISP) button |
| 10. Radio mode: Preset button | |
| | CD, AUX or Phone mode: Quick search button |
| 11. CD slot | |
| 12. CD eject button | |
| 13. Auxiliary (AUX) source button | |
| 14. Telephone button | |
| 15. Radio mode: TUNE dial | |
| | Audio unit mode: MENU dial |
| | Confirmation (ENTER) button |
| 16. Back button | |
| 17. SETUP button | |
| 18. Fast Forward (Cue) play/Forward Track button | |
| 19. Fast Reverse (Review) play/Reverse Track button | |
| 20. Traffic announcement (TA) button | |

4-30 Display screen, heater and air conditioner, and audio system



ANTI-THEFT SYSTEM

Use of a 4-digit radio PIN (Personal Identification Number) code, known only to the vehicle owner, effectively reduces the possibility of the audio unit being stolen. Without the PIN code the audio unit cannot be activated.

If force is used to try and remove the audio unit, the Anti-theft system activates and the audio unit is locked. The only way to unlock the audio unit is to enter the radio code number shown on an identification card supplied with the vehicle documentation.

NOTE

- The 4 digit radio code is shown on a card that you received with your vehicle documentation.
- Record the 4 digit radio code on the "Security information" page at the end of this manual. Remove the security page and keep it in a safe, not in the vehicle.
- Contact a NISSAN dealer if you do lose the 4 digit radio code of the audio unit.

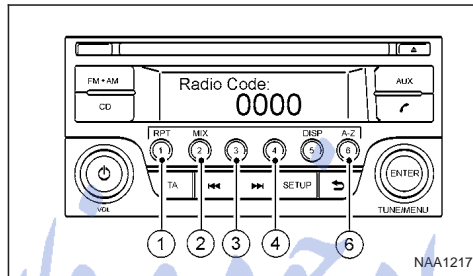

Unlocking the unit

If the battery supply to the vehicle is interrupted, the audio unit will lock.

When the power is restored and the unit switched on, the display will show [Radio Code:] and it will be unlocked when the codes have been entered correctly.

Unlocking procedure:

Read this section very carefully. It is important that the instructions are followed precisely.

To unlock the audio unit, proceed as follows:

1. Turn the ignition switch to the Acc or ON position.
2. [Radio Code:] is displayed along with four numerical zero digits.
3. Press preset button ① the number of times corresponding with the first digit of the radio code.

For example, if the radio code is 5169: for the first digit, "5", press the preset button ① five times.

4. The second, third, and fourth digits of the radio code must be entered, in the same way, only now using preset buttons ②, ③, and ④.

For example, press ② once, ③ six times, and ④ nine times.

5. Press with a long press preset button <⑥> to confirm the code. If you entered the code correctly the unit will switch on.

6. If the code is entered incorrectly a notification message [INCORRECT PIN] and the number of attempts left [REMAINING TRIES: XX] will be shown.

After reading the message, press the <ENTER> button to return to the entry screen and enter the correct radio code.

- If the wrong code is entered after the third attempt, the audio unit will lock for 60 minutes. The display will show a count down timer from 60 to 0 (minutes). After 60 minutes enter the correct radio code.
- If the wrong code is entered after eight sets of three entries, the audio unit will lock permanently. Contact a NISSAN dealer for further details.

AUDIO MAIN OPERATION

The audio unit operates when the ignition switch is in Acc or ON position.

Power ON/OFF button

Press the  button to switch on the audio unit. If the audio unit was switched off using the ignition switch, it can also be switched on with the ignition switch. The source that was playing immediately before the unit was switched off will resume playing and the volume will be set to the previous volume level.

The audio unit can be switched off by pressing , or by turning the ignition switch to the "OFF" or LOCK position.

Volume (VOL) level control

Turn the <VOL> dial clockwise or anticlockwise to adjust the volume level.

The audio unit is equipped with a speed control volume function, this means that the audio system automatically adjusts the volume level in relation to vehicle speed. For details, see "SPD VOL (Speed volume) control" later in this section.

Mute button (where fitted)

Press the  button to mute the sound and [MUTE] appears in the display. To cancel the mode, use any of the following options:

- Press  again.
- Turn the <VOL> dial.
- Press the <CD>, <FM•AM>, or <AUX> button.

Day/Night button (where fitted)

The illumination brightness level is linked to the headlight switch. When the headlights are switched "ON" the brightness is dimmed automatically. Press the button to toggle illumination brightness levels between daytime setting and nighttime setting independent of headlamp status.

RADIO OPERATION

When the  (power ON/OFF) button is pressed, the audio unit will switch on with the last received radio station, if the audio unit was previously switched off in radio mode.

Radio band select buttons

Press the <FM•AM> button to change the reception wave band as follows:

FM1 → FM2 → FMT → AM → FM1

When <FM•AM> button is pressed, the radio will come on at the last received radio station. If the CD or AUX source mode is already playing, pressing the <FM•AM> button will switch off the playing source mode and the last received radio station will be selected.

FM Auto store

When the <FM•AM> button is pressed for more than 1.5 seconds the six stations with the strongest signals are stored in the preset (1 to 6) buttons of the FMT band. During the search, a notification message [AUTOSTORE] appears in the display and the

sound is muted until the operation is complete. Once completed, the radio selects preset button ①.

Manual tuning

When adjusting the broadcasting station frequency manually, turn the <TUNE/MENU> dial until the desired station is tuned in.

The frequency increases or decreases in steps of 100 kHz on the FM band, and 9 kHz on the AM band.

WARNING

The radio should not be tuned while driving in order for full attention to be given to the driving operation.

SEEK tuning buttons

Pressing the <▶▶▶> or <◀◀◀> button starts the tuning mode. The radio tuner seeks from low to high or high to low frequencies and stops at the next broadcasting station. During seek mode, the audio output is muted. If no broadcasting station can be found within the complete band cycle, it will return to the initial frequency.

Preset station buttons ①②③④⑤⑥

Pressing a preset button for less than 2 seconds will select the stored radio station.

Pressing a preset button for more than 2 seconds will cause the station currently being received to be stored against that preset button.



- Eighteen stations can be stored in the FM band. (Six each for FM1, FM2 and FMT)
- Six stations can be set for the AM band.

If the battery is disconnected, or if the fuse blows, the radio memory will be erased. In that case, reset the desired stations after battery connection or fuse replacement.

Radio data system (RDS) operation

The RDS is a system through which encoded digital information is transmitted by FM radio stations in addition to the normal FM radio broadcasting. The RDS provides information services such as station name, traffic information, or news.

NOTE

In some countries or regions, some of these services may not be available.

Alternative Frequency (AF) mode:

The AF mode operates in the FM (radio) mode.

- The AF mode operates in the FM (radio), AUX or CD mode (if FM was previously selected in the radio mode).
- The AF function compares signal strengths and selects the station with the optimum reception conditions for the currently tuned-in station.

RDS functions

Programme Service (PS) function (station name display function):

When an RDS station is tuned in with seek or manual tuning, the RDS data is received and the PS name is displayed.

TA Traffic announcement

This function operates in FM (Radio), CD or AUX mode.

- Pressing the <TA> button selects the TA mode. The TA indicator is displayed while TA mode is on.
- When <TA> is pressed again. The mode will be switched off and the TA indicator will disappear from the display.

Traffic announcement interrupt function:

When a traffic announcement is received, the announcement is tuned in and the display shows a notification message with the radio station name e.g. [TA: Radio 1].

Once the traffic announcement has finished, the unit returns to the source that was active before the traffic announcement started.

If <TA> is pressed during a traffic announcement, the traffic announcement interrupt mode is cancelled. The TA mode returns to the standby mode and the audio unit returns to the previous source.

SETUP BUTTON

To configure Audio, Clock, Bluetooth, Language or Scroll direction settings, perform the following procedure:

1. Press the <SETUP> button.
2. Turn the <TUNE/MENU> dial clockwise or anti-clockwise, the display will appear in the following order:

[Audio] ⇔ [Clock] ⇔ [Bluetooth] ⇔ [Language] ⇔ [Scroll Direction]

After the desired levels have been set, press either the  (Back) button repeatedly, the <SETUP> button, or wait for 8 seconds without pressing any buttons to exit the menu screen.

Display brightness (Day/Night mode)

Press the <SETUP> button with a long press to switch the display brightness between the daytime and nighttime mode.

Audio adjustments

Press the <SETUP> button to enter the setup menu screen then select [Audio].

Each time the <ENTER> button is pressed, the mode will change as follows:

[Bass] → [Treble] → [Balance] → [Fade] → [AUX VOL] → [SPD VOL] → setup menu screen [Audio] → [Bass]

Bass control:

Use this control to enhance or attenuate bass response sound.

Turn the <TUNE/MENU> dial clockwise or anticlockwise to adjust the bass settings then press <ENTER> to confirm.

Treble control:

Use this control to enhance or attenuate the treble.

Turn the <TUNE/MENU> dial clockwise or anticlockwise to adjust the treble settings then press <ENTER> to confirm.

Balance control:

Use this control to adjust the balance of the volume between the left and right speakers.

Turn the <TUNE/MENU> dial anticlockwise or clockwise to adjust the left/right balance then press <ENTER> to confirm.

Fade (Fader) control:

Use this control to adjust the balance of the volume between the front and rear (where fitted) speakers.

Turn the <TUNE/MENU> dial anticlockwise or clockwise to adjust the front/rear balance then press <ENTER> to confirm.

AUX VOL (Auxiliary volume) control:

Use this control to adjust the volume output from the auxiliary source.

Turn the <TUNE/MENU> dial anticlockwise or clockwise to select [LO], [MID], or [HI] mode then press <ENTER> to confirm.

SPD VOL (Speed volume) control:

This mode controls the volume output from the speakers automatically in relation to vehicle speed.

When [SPD VOL] is displayed, turn the <TUNE/MENU> dial clockwise or anticlockwise to adjust the volume level.

Adjusting the setting to 0 (zero) turns off the speed volume feature. Increasing the speed volume setting results in the audio volume increasing more rapidly with vehicle speed. Once chosen, press <ENTER> to save the setting.

Clock setting

The [Clock] set up screen will appear when selecting the [Clock] item from the set up menu.

[Set Time]:

Select [Set Time] then adjust the clock as follows:

1. The hour display will start flashing. Turn the <TUNE/MENU> dial to adjust the hour.
2. Press the <ENTER> button. The minute display will start flashing.
3. Turn the <TUNE/MENU> dial to adjust the minute.

4. Press <ENTER> to finish the clock adjustment.

[On/Off]:

Set the clock display between on or off when the audio unit is turned off.

If set in the [ON] position, the clock will be displayed when the audio unit is turned off either by pressing the  button or when the ignition switch is placed in the "OFF" position.

[Clock Format]:

Set the clock display between 24-hour mode and 12-hour clock mode.

Bluetooth®

For activation or deactivation details, see "Bluetooth® operation" later in this section.

Language

Select the appropriate language and press the <ENTER> button. Upon completion, the screen will automatically adapt the language setting.

- [French]
- [English]
- [German]
- [Spanish]
- [Portuguese]
- [Italian]
- [Dutch]
- [Turkish]



- [Russian]

Scroll direction

Sets the scroll direction of the <TUNE/MENU> dial. For example, to change the way in which you turn the dial (anticlockwise or clockwise) in order to scroll up or down a list.

COMPACT DISC (CD) OPERATION

The CD player can play a music CD or an encoded MP3/WMA CD and while listening to those CD's certain text might be able to be displayed (when CD encoded with text is being used).

Press the <CD> button and the CD (if loaded) will start to play.

When <CD> is pressed and the radio or AUX source mode is already operating, it will automatically turn off the playing source and the CD play mode will start.

However, if the CD disc is not loaded, then a notification message will be displayed and the audio unit remains in radio or AUX source mode.

CAUTION

- Do not force the CD into the slot. This could damage the player.
- Do not use 8 cm (3.1 in) discs.

CD insert (CD player)

Insert the CD disc into the slot with the label side facing up. The disc will be guided automatically into the slot and will start playing. After loading the disc, track information will be displayed.

NOTE

- The CD player accepts normal audio CD or CD recorded with MP3/WMA files.
- Inserting a CD recorded with MP3/WMA files, the audio unit will automatically detect and [MP3CD] will be indicated.
- An error notification message will be displayed when inserting a wrong disc type (e.g. DVD), or the player cannot read the CD disc. Eject the disc and insert another disc.



CD button

Press the <CD> button to start playing the loaded CD. Playing starts from the track that was being played when the CD play mode was switched off.

Audio main operation

List view:

While the track is being played, press either the <ENTER> or  button to display the available tracks in a listed view mode. To select a track from the list, or a track to start listening from, turn the <TUNE/MENU> dial then press <ENTER>.



Quick search:

In the list view mode, quick search can be performed to find a track from the list.

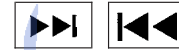
Push the <A-Z>  button then turn the <TUNE/MENU> dial for the first alphabetic/numerical letter of the track title then press <ENTER>. When found, a list of the available tracks will be displayed. Select, and press <ENTER> to play the preferred track.





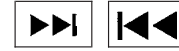

Fast Forward (Cue), Fast Reverse (Review) buttons:

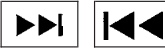

When the  (Cue) or  (Review) button is pressed continuously, the track will be played at high speed. When the button is released, the track will be played at normal playing speed.





Track up/down buttons:

Pressing the  or  button once, the track will be skipped forward to the next track or backward to the beginning of the current played track. Press the  or  button more than once to skip through the tracks.

Folder browsing:

If the recorded media contains folders with music files, pressing the  or  button will play in sequence the tracks of each folder.

To select a preferred folder:

1. Press the <ENTER> or  button and a list of tracks in the current folder is displayed.
2. Press the  button.

3. Turn the <TUNE/MENU> dial for the preferred folder.

4. Press <ENTER> to access the folder. Press <ENTER> again to start playing the first track or turn the <TUNE/MENU> dial, and press <ENTER> to select another track.

If the current selected folder contains sub folders, press <ENTER>, a new screen with a list of sub folders will be displayed. Turn the <TUNE/MENU> dial for the sub folder then press <ENTER> to select. Select the [Root] folder item when songs are recorded additionally in the root folder.

To return to the previous folder screen, press .

RPT Repeat button:

Push the **RPT** ① button and the current track will be played continuously.

MIX button:

Push the **MIX** ② button and all the tracks will be played in a random order.

DISP button:

While a CD with recorded music information tags (CD-text/ID3-text tags) is being played, the title of the played track is displayed. If the title information is not provided then [Track] is displayed.

When the **DISP** ⑤ button is pressed repeatedly, further information about the track can be displayed along with the track title as follows:

CD:

Track time → Artist name → Track title → Album title → Track time

CD with MP3/WMA:

Track time → Artist name → Album title → Folder name → Track time

Track details:

A long press on the **DISP** ⑤ button will turn the display into a detailed overview and after a few seconds it returns to the main display, or press **DISP** ⑤ briefly.



CD eject button

CD player:

Press the  (eject) button and the CD will be ejected.

Ejecting CD (with ignition switch in "OFF" or LOCK):

When the ignition switch is in the "OFF" or LOCK position it is possible to eject the currently played CD. However the audio unit will not be activated.

Press the  button and the CD will be ejected.

NOTE

- When the CD is ejected and not removed within 8 seconds, it will automatically retract into the slot to protect it from damage.
- If an error message appears in the display, press  to eject the faulty CD and insert another CD or check if the ejected CD is inserted upside down.

AUX SOCKET

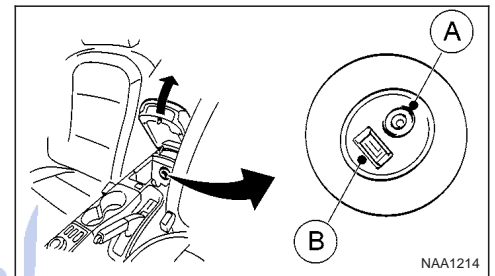

Ⓐ AUX

Ⓑ USB (where fitted)

Audio main operation

Open the lid and connect the lead with the jack of a compatible player (e.g. MP3 player) to the socket Ⓐ.

Press the <AUX> button for the AUX mode.



USB MEMORY OPERATION (where fitted)

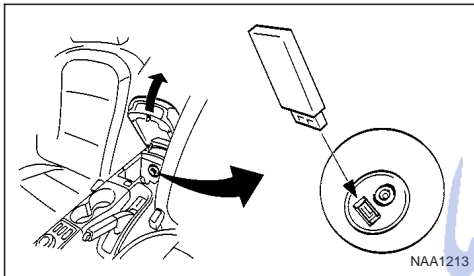

Connecting USB memory

Open the console lid and connect a USB memory stick as illustrated. The display will show a notification message, for a few seconds, that it is reading the data.

If the audio system has been turned off while the USB memory was playing, pressing ⏻ will start the USB memory operation.

<AUX> button

To operate the USB memory use one of the following methods:

- Press the <AUX> button then turn the <TUNE/MENU> dial to the [USB] item. Once highlighted, press <ENTER>.
- Press <AUX> repeatedly until [USB] is highlighted, then press <ENTER>.

Audio main operation

The following operations are identical to the audio main operation of the Compact Disc (CD) operation. For details, see "Compact Disc (CD) operation" earlier in this section.

- List view
- Quick search
- ▶▶ , ◀◀
- MIX (Random play)
- RPT (Repeat track)
- Folder browsing

DISP button ⑤

While a track with recorded music information tags (ID3-tags) is being played, the title of the played track is displayed. If the tags are not provided then a notification message is displayed.

When the DISP ⑤ button is pressed repeatedly, further information about the track can be displayed along with the track title as follows:

Track time → Artist name → Album title → Folder name → Track time

Track details:

A long press on the DISP ⑤ button will turn the display into a detailed overview and after a few seconds it returns to the main display, or press DISP ⑤ briefly.

iPod® PLAYER OPERATION (where fitted)

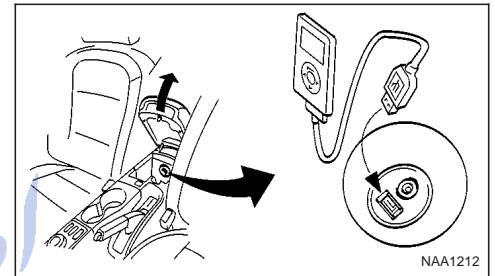

Connecting iPod®

Open the console lid and connect the iPod cable to the USB connector. The battery of the iPod® will be charged during the connection to the vehicle. The display will show a notification message, for a few seconds, that it is reading the data.

If the audio system has been turned off while the iPod® was playing, pressing ⏻ will start the iPod® operation. During the connection, the iPod® can only be operated with the audio controls.

* iPod® and iPhone® are trademarks of Apple Inc., registered in the U.S. and other countries.

Compatibility:

The following compatible models are:

- iPhone 3GS® (firmware version 3.1.2 or later)

- First generation:
iPod nano® (firmware version 1.3.1 or later)
iPod touch® (firmware version 2.2.1 or later)
iPhone® (firmware version 2.2.1 or later)
- Second generation:
iPod touch® (firmware version 3.1.2 or later)
iPod nano® (firmware version 1.1.3 or later)
iPhone 3G® (firmware version 3.1.3 or later)
- Third generation
iPod touch® (firmware version 3.1.3 or later)
iPod nano® (firmware version 1.1.3 PC or later)
- Fourth generation: iPod Classic® (firmware version 3.1.1 or later)
- Fifth generation:
iPod Nano® (firmware version 1.0.2 PC or later)
iPod Video® (firmware version 1.3 or later)
- Sixth generation:
iPod Classic® 80GB (firmware version 1.1.2 PC or later)
iPod Classic® 120GB (firmware version 1.1.2 or later)
iPod Classic® 160GB (firmware version 2.0.4 PC or later)

NOTE

- **At the time of publication, this audio system was tested with the latest iPod® players/iPhone® available. Due to the frequent update of consumer devices like MP3 players, NISSAN cannot guarantee that all new iPod® players/iPhone® launched will be compatible with this audio system.**

- **Some iPod® operations may not be available with this system.**
- **Make sure that the iPods®/iPhones® is updated with the latest firmware.**
- **iPod® Shuffle and iPod® mini cannot be used with this system.**

<AUX> button

To operate the iPod® use one of the following methods:

- Press the <AUX> button then turn the <TUNE/MENU> dial for the [iPod] item. Once highlighted, press <ENTER>.
- Press <AUX> repeatedly until [iPod] is highlighted then press <ENTER>.

Audio main operation

Interface:

The interface for iPod® operation shown on the audio system display is similar to the iPod® interface. Use the <TUNE/MENU> dial and the <ENTER> button to play a track on the iPod®.

The following items can be chosen from the menu list screen.

- [Playlists]
- [Artist]
- [Albums]
- [Songs]

For further information about each item, see the iPod® owner's manual.

The following operations are identical to the audio main operation of the Compact Disc (CD) operation. For details, see "Compact Disc (CD) operation" earlier in this section.

- List view
- Quick search
- 
- MIX (Random play)
- RPT (Repeat track)
- Folder browsing

DISP button ⑤

While a track with recorded music information tags (ID3-tags) is being played, the title of the played track is displayed. If the tags are not provided then a notification message is displayed.

When the DISP ⑤ button is pressed repeatedly, further information about the track can be displayed along with the track title as follows:

Track time → Artist name → Album title → Track time

Track details:

A long press on the DISP ⑤ button, the screen displays the song title, artist name, and album title. After a few seconds it returns to the main display or press DISP ⑤ briefly.



BLUETOOTH® OPERATION

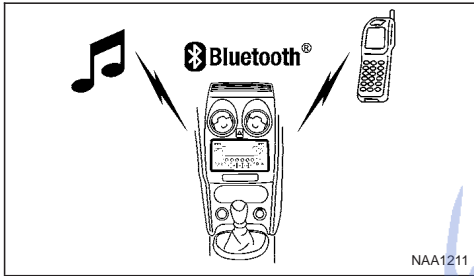

Regulatory information



Bluetooth® is a trademark owned by Bluetooth SIG, Inc.

CE statement

Hereby DAEWOO IS Corp. declares that this system is in compliance with the essential requirements and other relevant provisions of Directive 1999/5/EC.



NOTE

The audio system only supports Bluetooth® devices with AVRCP (Audio Video Remote Control Profile) version 1.3, or 1.0 or earlier.

BLUETOOTH® settings

To set up the Bluetooth system with your preferred device, push the <SETUP> button and select [Bluetooth], then push the <ENTER> button or alternatively, press the  button. The following items are available:

- [Pair Device]

Bluetooth devices can be paired with the system. A maximum of 5 Bluetooth devices can be registered.

- [Select Device]

Paired Bluetooth devices are listed and can be selected for connection.

- [Delete Device]

A registered Bluetooth device can be deleted.

- [On/Off]

If this setting is turned off, the connection between the Bluetooth devices and the in-vehicle Bluetooth module will be cancelled.

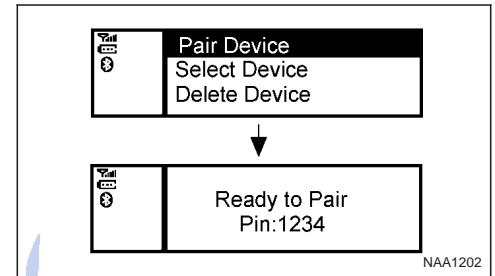

[Pair Device]:

1. Press the <SETUP> button. Select the [Bluetooth] key using the <TUNE/MENU> dial. Then press the <ENTER> button.

You can register up to 5 different Bluetooth mobile phones. However, you can only use one device at a time. If you have 5 different Bluetooth registered devices, a new device can only replace one of the 5 existing paired devices. Use [Delete Device] key to delete one of the existing paired devices. For details, see "[Delete Device]" later in this section.

2. Select the [Pair Device] key.

The pairing procedure depends on the connected device:

- Mobile phone:

The message [Ready to Pair Pin:1234] will be displayed.

- Audio device without PIN code:

The Bluetooth connection will be automatically connected without any further input.

- Audio device with PIN code:

A new screen will appear. Assign the 4 digit PIN code by turning the <TUNE/MENU> dial to each code and press the <ENTER> button to confirm. Then select [Validate] and press <ENTER>. The Bluetooth connection will be made.

The 4-digit PIN code is provided with the audio device, see the owner's manual of the audio device.

3. On Bluetooth® audio/mobile phone devices.

- 1) Switch on the Bluetooth® connection, if not already switched on.
- 2) Switch on the search mode for Bluetooth® devices. If the search mode finds a device it will be shown on the device display.
- 3) When a device is found use the <TUNE/MENU> dial to scroll to, and press <ENTER> to select [My Car].
- 4) Enter the number code shown on the relevant device with the device's own keypad, and press the confirmation key on the device itself. Refer to the relevant Bluetooth® device owner's manual for further details.

When successfully paired a notification message will be displayed, then the audio system display

will return to the current audio source display. During connection the following status icons will be displayed (top left of the display): Signal strength (📶), Battery status* (🔋) and Bluetooth "ON" (📶).

*: If the low battery message comes on, the Bluetooth® device must be recharged soon.

The pairing procedure and operation may vary according to device type and compatibility. See the Bluetooth® owner's manual for further details.

NOTE

- For device details, see your audio/mobile phone Owner's Manual.
- For assistance with the Bluetooth® audio/mobile phone integration, please visit your local NISSAN dealer.

[Select Device]:

The paired device list shows which Bluetooth® audio or mobile phone devices have been paired or registered with the Bluetooth® audio system. If the list contains devices then select the appropriate device to connect to the Bluetooth® audio system.

The following symbols (where fitted) indicate the capability of the registered device:

- 📶 : Mobile phone integration
- 🎵 : Audio streaming (A2DP – Advanced Audio Distribution Profile)

[Delete Device]:

A registered device can be removed from the Bluetooth audio system. Select a registered device then press <ENTER> to confirm to deletion.

[On/Off]:

If Bluetooth® has been switched off a notification message [On/Off] appears when you select [Bluetooth] from the setup menu screen, or press 📶. To switch the Bluetooth® signal on, press <ENTER> and a follow up screen will appear. Then select [On] and press <ENTER> to display the Bluetooth® settings menu screen.

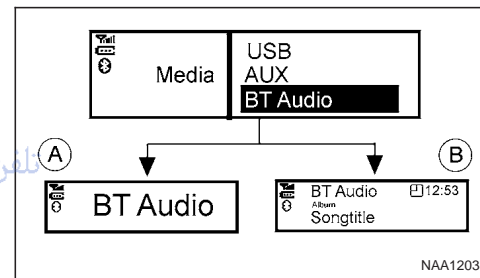

Bluetooth® audio streaming main operation

Turn the ignition switch to the Acc or ON position. If the audio system was turned off while the Bluetooth® audio was playing, pressing the <📶> button will start the Bluetooth® audio streaming.



<AUX> button:

To operate the Bluetooth audio streaming use one of the following methods:

- Press the <AUX> button, then turn the <TUNE/MENU> dial to highlight [BT Audio], and press <ENTER>.
- Press <AUX> repeatedly until [BT Audio] is highlighted, then press <ENTER>.

The type of display, (A) or (B), shown on the audio system can vary depending on the Bluetooth® version of the device.



Fast Forward (Cue), Fast Reverse (Review) buttons:

When the ►► (Cue) or ◀◀ (Review) button is pressed continuously, the track will be played at high speed. When the button is released, the track will be played at normal playing speed.



Track up/down buttons:

Pressing the ►► or ◀◀ button once, the track will be skipped forward to the next track or backward to the beginning of the current played track. Press the ►► or ◀◀ button more than once to skip through the tracks.

Play/Pause:

Press the <ENTER> button to pause. To resume, press <ENTER> again.

DISP button (5) (Type B display screen only)

If the song contains music information tags (ID3-tags), the title of the played song will be displayed. If tags are not provided then the display will not show any messages.

When the DISP (5) button is pressed repeatedly further information about the song can be displayed along with the song title.

A long press on DISP (5) will turn the display into a detailed overview which after a few seconds returns to the main display; or press DISP (5) briefly.

Bluetooth® mobile phone feature

This system offers a hands-free facility for your mobile telephone with Bluetooth® to enhance driving safety, and comfort.

For details, see “Mobile phone integration for FM AM radio with CD player” later in this section.

Specification chart

Supported media		CD, CD-R, CD-RW	
Supported file systems		ISO9660 LEVEL1, ISO9660 LEVEL2, Romeo, Joliet * ISO9660 Level 3 (packet writing) is not supported. * Files saved using the Live File System Component (on a Windows Vista-based computer) are not supported.	
Supported versions*1	MP3	Version	MPEG1, MPEG2, MPEG2.5
		Sampling frequency	32 KHz - 44.1 KHz - 48 KHz
		Bit rate	32, 40, 48, 56, 64, 80, 96, 112, 128, 144, 160, 192, 224, 256, 288, 320, 336, 384, 448, VBR. Kbps *4
	WMA*3	Version	WMA7, WMA8, WMA9
		Sampling frequency	16 KHz, 22.05 KHz, 32 KHz, 44.1KHz, 48 KHz
		Bit rate	48, 64, 80, 96, 128, 160, 192, 256, 320, VBR kbps *4
Tag information (Song title and Artist name)		ID tag VER. 1.0, 1.1, 2.2, 2.3 (MP3 only) WMA tag (WMA only)	
Folder levels		Folder levels: 8, Folders: 255 (including root folder), files: 512	
Text character number limitation		File Name: Min 11 Characters (Max 30 Characters) ID3 TAG : Min 24 Characters. (Max 60 Characters)*	
Displayable character codes*2		01:ASCII, 02: ISO-8859-1 03: UNICODE(UTF-16 BOM Big Endian), 04: UNICODE(UTF-16 Ncn-BOM Big Endian), 05: UNICODE(UTF-8), 06:UNICODE(Non-UTF-16 BOM Little Endian), 07: SHIFT-JIS	

*1 Files created with a combination of 48 kHz sampling frequency and 64 kbps bit rate cannot be played.

*2 Available codes depend on what kind of media, versions and information are going to be displayed.

*3 Protected WMA files (DRM) cannot be played.

*4 When VBR files are played, the playback time may not be displayed correctly. WMA7 and WMA8 are not applied to VBR.

*5 Support 128 Bytes but it depends on display width and character type.

4-42 Display screen, heater and air conditioner, and audio system



NISSAN CONNECT (where fitted)

STEERING WHEEL SWITCH FOR AUDIO CONTROL (where fitted)

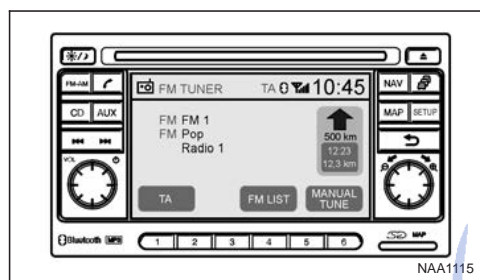

MAIN OPERATION

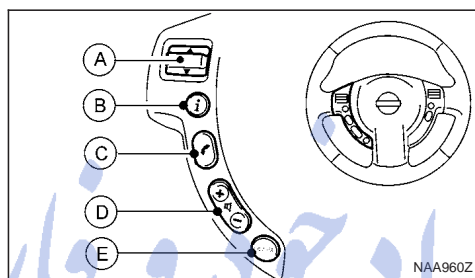

- (A) Scrolling switch
- (B) ⓘ (INFO) button
- (C) Telephone button
- (D) Volume control buttons
- (E) Source button

The audio system can be operated using the controls on the steering-wheel.

To use the steering wheel audio switch, push the power "ON" button of the audio unit with the ignition switch in either the Acc or ON position.

NOTE

For models with NISSAN Connect system, the steering switch for audio control is described in the separately provided NISSAN Connect Owner's Manual.

▲ or ▼ Scrolling switch

- Preset station change (radio mode)
Push the up/down scrolling switch (▲ or ▼) for less than 1.5 seconds to select one of the preset radio stations.
- Seek tuning (radio mode)
Push the up/down scrolling switch (▲ or ▼) for more than 1.5 seconds to seek for the next or previous radio station.
- Track up/down (CD mode)
Push the up/down scrolling switch (▲ or ▼) for less than 1.5 seconds to select the next track or to return to the beginning of the present track. Push (up/down) several times to skip through or skip back the tracks.
- DISC change (CD mode — where fitted)
Push the up/down scrolling switch (▲ or ▼) for more than 1.5 seconds to change the playing disc.

ⓘ INFO button

For additional information on the ⓘ button, see "Vehicle information display" in the "2. Instruments and controls" section.

☎ Telephone button

For additional information on the telephone button, see "Mobile phone integration for LW-MW-FM radio with CD player or 6 CD changer (Type A)" later

CAR PHONE OR CB RADIO

in this section or "Mobile phone integration for FM AM radio with CD player" later in this section.

SOURCE button

Repeatedly press the SOURCE button to select a source.

Volume control buttons

Press the + or — button to adjust the volume.

When installing large capacity wireless equipment or a car phone in your NISSAN, be sure to observe the following as it may adversely affect the Engine control system and other electronic parts depending on its installation location.

CAUTION

- Keep the antenna as far as possible away from the Electric Control Module.
- Also keep the antenna wire more than 20 cm (8 inches) away from the Electro Injection harness. Do not route the antenna wire next to any harness.
- Adjust the antenna standing-wave ratio as recommended by the manufacturer.
- Connect the ground wire from the radio chassis to the body.

NOTE

For further information, visit the NISSAN web site: www.nissan-europe.com. Select your country from the list and go to the "SERVICES" menu. If not available on the web site, contact a NISSAN dealer or qualified workshop.

MOBILE PHONE INTEGRATION FOR LW-MW-FM RADIO WITH CD PLAYER OR 6 CD CHANGER (Type A)

BLUETOOTH® MOBILE PHONE FEATURE

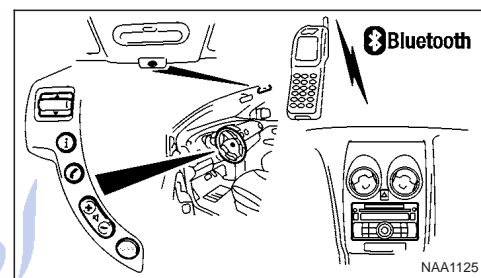

WARNING

Whilst driving, using the mobile phone is extremely dangerous because it significantly impairs your concentration and diminishes your reaction capabilities to sudden changes on the road, and it may lead to a fatal accident. This applies to all phone call situations such as when receiving an incoming call, during a phone conversation, when calling through the phone book search, etc.

CAUTION

Certain country jurisdictions prohibit the use of the mobile phone in the car without hands-free support.

This chapter provides information about the NISSAN hands-free phone system using a Bluetooth® connection.

Bluetooth® is a wireless radio communication standard. This system offers a hands-free facility for your mobile telephone to enhance driving comfort.

NOTE

For models with NISSAN Connect system, see the separately provided Owner's Manual.

In order to use your mobile phone with the Bluetooth® of the audio system, the mobile phone must first be set-up. For details, see "Hands-free telephone setup" later in this section. Once it has been set-up, the hands-free mode is automatically activated on the registered mobile phone (via Bluetooth®) when it comes into range.

A notification message on the audio display comes on when the phone is connected, when an incoming call is being received as well as when a call is initiated.

When a call is active, the audio system, microphone (located in the ceiling in front of the rear view mirror) and the steering wheel switches enable hands-free communication.

If the audio system is being used at the time, the radio or CD mode will be muted and will stay muted until the active call has ended.

If the Bluetooth® system is unable to connect with your mobile phone, this may occur because:

- The mobile phone is too far away from the vehicle.
- The Bluetooth® mode on your mobile phone has not been activated.

- Your mobile phone has not been paired with the Bluetooth® system of the audio unit.
- The mobile phone does not support Bluetooth® technology (BT Core v1.2, Hands Free Profile v1.0 and Object Push Profile v1.0).

NOTE

- For details, see your mobile phone's Owner's Manual.
- For assistance with your mobile phone integration, please visit your local NISSAN dealer.

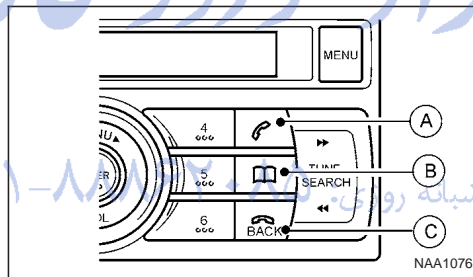

Hands-free telephone setup

- (A) Phone button
- (B) Phone book button
- (C) Phone end/ BACK button

The following options can be selected:

- Paired list
- Pair phone

- Delete phone
- Bluetooth® connection
- Delete phone book

Pairing procedure:

If you wish to make a Bluetooth® connection for the first time between your mobile phone and the Bluetooth® system of the audio unit, follow the pairing procedure as described below:

- 1) Turn the ignition switch to the Acc position.
- 2) Switch on the audio system and your mobile phone.

For the vehicle:

- 1) Briefly press <MENU> button.
- 2) Press <ENTER> button.
- 3) Turn the <MENU/VOL> dial and select [PAIR PHONE] then press <ENTER> button.
- 4) The display shows [READY TO PAIR] then [PASSCODE=1234].

On the mobile phone:

- 1) Activate the Bluetooth® connection.
- 2) Activate the search mode for Bluetooth® equipment. Refer to your mobile phone manual for further details. If the search mode finds the device, it will be shown on your mobile phone display.
- 3) Select the device name [MY CAR].
- 4) Enter the passcode number 1234 as shown on the display of the audio unit with the keypad on

your mobile phone then press the confirmation button on your mobile phone.

Action	Screen display
Press briefly <MENU> button	
↓	[PHONE SETUP]
Press <ENTER> button	
↓	[PAIRED LIST]
Turn <MENU/VOL> dial	[PAIR PHONE]
↓	
Press <ENTER> button	[READY TO PAIR]
↓	[PASSCODE=1234]
Your mobile phone setup: select MY CAR then enter 1234	
↓	
If successful	[PAIRING OK]
↓	[*] CONNECT OK
	Mobile 1 *1
	[PAIR PHONE]
Press  button repeatedly for the main screen.	

*1 Mobile name

Once the connection is finalised, the audio unit will automatically register the mobile phone and the audio unit display shows [PAIRING OK] and [*] CONNECT OK]. If it fails to register [PAIRING FAIL] then start the procedure, previously described, again or consult your mobile phone manual.

You can register up to 5 different Bluetooth® mobile phones. However, you can only use one mobile phone at a time. If you have 5 different Bluetooth® mobile phones registered, a new mobile phone can only replace one of the 5 existing paired mobile phones. Use [DEL PHONE] to delete one of the existing paired mobile phones.

Paired phone list:

The paired phone list shows which mobile phones have been paired or registered with the Bluetooth® system. If the list contains multiple mobile phones then you can select the appropriate mobile phone to connect with the Bluetooth® system.

Action	Screen display
Briefly press <MENU> button	
↓	[PHONE SETUP]
Press <ENTER> button	
↓	[PAIRED LIST]
Press <ENTER> button	
↓	Mobile 1
Turn <MENU/VOL> dial	Mobile 2
↓	
Press <ENTER> button	[PLEASE WAIT]
↓	[*] CONNECT OK [*] CONNECT FAIL
	[PAIRED LIST]
Press  button repeatedly for the main screen.	

In the above example procedure, "Mobile 2" will be connected.

4-46 Display screen, heater and air conditioner, and audio system

Removing a paired phone:

Deletes the connection between the Bluetooth® system and the registered mobile phone.

Action	Screen display
Briefly press <MENU> button	
↓	[PHONE SETUP]
Press <ENTER> button	
↓	[PAIRED LIST]
Turn <MENU/VOL> dial	
↓	[DEL PHONE]
Press <ENTER> button	
↓	Mobile 1
Turn <MENU/VOL> dial	Mobile 2
↓	
Press <ENTER> button	[DELETE?] [YES]
↓	
Press <ENTER> button *	[DELETED]
↓	[DEL PHONE]
Press  button repeatedly for the main screen.	

* For the "Mobile 2" connection the screen displays [DISCONNECTED], followed by "Mobile 2", then [DELETED].

In the above example, "Mobile 2" will be deleted while "Mobile 1" remains connected to the system.

Bluetooth® activation:

Activates or deactivates the Bluetooth® function. You will need to activate the Bluetooth® function in order to enable your hands-free phone system (except in the pairing mode where it will be activated automatically).

Action	Screen display
Briefly press <MENU> button	
↓	[PHONE SETUP]
Press <ENTER> button	
↓	[PAIRED LIST]
Turn <MENU/VOL> dial	[BLUETOOTH]
↓	
Press <ENTER> button	[B'TOOTH <OFF>]
↓	
Turn <MENU/VOL> dial	[B'TOOTH <ON>]
↓	
Press <ENTER> button	[BLUETOOTH]
	[] [CONNECT OK]
	Mobile name
	Main screen

Delete phone book list:

To delete all the contacts from the phone book, proceed as follows:

Action	Screen display
Briefly press <MENU> button	
↓	[PHONE SETUP]
Press <ENTER> button	
↓	[PAIRED LIST]
Turn <MENU/VOL> dial	[DEL P.BOOK]
↓	
Press <ENTER> button	[DEL ALL? <NO>]
↓	
Turn <MENU/VOL> dial	[DEL ALL? <YES>]
↓	
Press <ENTER> button	[DELETING]
↓	[DELETED]
	[DEL P.BOOK]
Press  button repeatedly for the main screen.	

Phone book

When the  (phone book) button is pressed, the following options can be selected by turning the <MENU/VOL> dial in either direction.

- [SEARCH]
- Names (contact names)
- Speed dial mode [1NAME]

- [DELETE NAME]
- [EDIT NAME]
- [ADD NAME]
- Send name using Bluetooth® technology [Bluetooth ADD NAME]

The phone book can store up to 100 names with numbers and can be selected for calling. To add a contact to the phone book proceed as follows:

Action	Screen display
Press with a long press the  button	
↓	[ADD NAME]
Press <ENTER> button	
↓	[ENTER NAME]
Turn <MENU/VOL> dial	[ABC]
↓ Focus on "J"	[JK]
Press <ENTER> button	
↓	
Turn <MENU/VOL> dial Focus on "O"	[NOP]
↓	
Press <ENTER> button	
↓ *1 *3	[JO]
Turn <MENU/VOL> dial	[OK <@OKA>]
↓	
Press <ENTER> button	
↓	[ENTER NUMBER]
Press <ENTER> then turn <MENU/VOL> dial	1
↓ *2 *3	
Press <ENTER> button	[123456789]
↓	
Turn <MENU/VOL> dial	
↓	[OK <@OK0>]



Action	Screen display
↓	[OK <@OK0>]
Press <ENTER> button	[SAVED]
Press  button for the main screen.	

NOTE

In the above example the contact name JO and phone number 123456789 will be added.

*1 To insert special characters select the following character options A: Alphabetic characters, 1/2: Numerical characters, Å: Latin characters and @: Symbol characters.

*2 Select the number then confirm your selection by pressing the <ENTER> button then proceed likewise for every number.

*3 To correct an entry, briefly press the  (back) button then enter the correct details. To delete all characters press the  (back) button for more than 1 second.



NOTE

You can also store the name and the phone number in one of the six preset buttons on the audio unit for frequent use phone numbers.

Transferring an entry to the Phone book:

You can also send a name (contact) from a connected mobile phone to the phone book using Bluetooth® technology.



Action	Screen display
Briefly press  button	
↓	[SEARCH]
Turn <MENU/VOL> dial	[ ADD NAME]
↓	
Press <ENTER> button	[SEND NAME]
↓ *1 *2	[JOE]
↓ *3	[0123456789]
Press <ENTER> button	
↓	[SAVE? <YES>]
Press <ENTER> button	
↓ *4	[SAVED] [SEND NAME]
Press  button repeatedly for the main screen.	

*1 The Bluetooth® icon will blink for 2 minutes.

*2 Send the name (contact) via the registered mobile phone within the 2 minutes.

*3 Phone number is displayed.

*4 During the saving operation, the Bluetooth® connection will be temporarily disconnected.

EDIT:



You can edit a name or phone number stored in the phone book.

Action	Screen display
Briefly press  button	
↓	[SEARCH]
Turn <MENU/VOL> dial	[EDIT NAME]
↓	
Press <ENTER> button	[SEARCH]
↓ *1	[JOE]
Turn <MENU/VOL> dial	[JOE]
↓	
Press <ENTER> button	
↓	[JOE OK <@OKA>]
Turn <MENU/VOL> dial	
↓ Focus on "Y"	[JOE <XYZ>]
Press <ENTER> button	
↓ *2	[JOEY]
Turn <MENU/VOL> dial	
↓ *3	[OK <@OKA>]
Press <ENTER> button	
↓	[EDIT NUMBER]
↓	[OK <@OK0>]
Press <ENTER> button	
↓	

Action	Screen display
↓	[SAVED] [EDIT NAME]
Press  button for the main screen.	

*1 Alternatively use the search mode to select the appropriate entry to edit.



- [SEARCH] appears on the display then press the <ENTER> button.
- Turn the <MENU/VOL> dial to select the first character of the name then press the <ENTER> button.
- The name should be displayed. If necessary, turn the <MENU/VOL> dial to select the correct name.

*2 When the  button is pressed briefly, the cursor will move one step backwards and the last character will be deleted. To delete all characters press the  button for more than 1 second.

*3 If necessary, you can edit the telephone number. After editing the name, select [OK] then press the <ENTER> button to confirm and edit the number as described for name editing.

Delete a name:

To delete a name (contact) from the phone book, proceed as follows:

Action	Screen display
Briefly press  button	
↓	[SEARCH]
Turn <MENU/VOL> dial	
↓	[DELETE NAME]
Press <ENTER> button	
↓*1	[SEARCH]
Turn <MENU/VOL> dial	[JOE]
↓	
Press <ENTER> button	
↓	[DELETE ? <YES>]
Press <ENTER> button	
↓	[DELETED]
Press  button for the main screen.	

- *1 Alternatively use the search mode to select the appropriate entry to delete.
- [SEARCH] appears on the display then press the <ENTER> button.
 - Turn the <MENU/VOL> dial to select the first character of the name then press the <ENTER> button.
 - The name should be displayed. If necessary, turn the <MENU/VOL> dial to select the correct name.

Speed dial buttons:

After entering the names and phone numbers, you can assign the six preset buttons to the most frequently dialed phone numbers.

- 1) Press the  (phone book) button.
- 2) Select the name by turning the <MENU/VOL> dial or using the search name mode.
- 3) Once found, press the assigned preset button until a confirmation beep is heard. The name and phone number is now stored under that button.

Hands-free telephone control

The hands-free mode can be operated using the telephone button controls on the audio unit or on the steering wheel (where fitted).

Initiating a call:

A call can be initiated using one of the following methods:

- redial
- phone book
- voice tag
- speed dial (preset buttons)



NOTE

During the active call you can adjust the microphone volume by pressing briefly on the <MENU> button then adjust the volume by turning the <MENU/VOL> dial within the value range of -2

to +2. To confirm the entry, press briefly on the <ENTER> or  (Back) button or wait for 10 seconds to return to the active call main screen.



Redial:

Use the redial mode to call the last number that was dialed.

- 1) Press the  (phone) button briefly.
- 2) Select [REDIAL].
- 3) Press the <ENTER> or the  (phone) button to redial the last number.

Make a call from the phone book:

In order to dial a contact from the phone book, proceed as follows:

- 1) Press the phone book () button.
- 2) Turn the <MENU/VOL> dial and select the correspondent name.
- 3) Press the <ENTER> or  (phone) button in order to dial the number.

Alternatively you can use the search mode as follows:

- 1) Briefly press the phone book () button.
- 2) [SEARCH] appears on the display then press the <ENTER> button.
- 3) Select the first character of the name then the <ENTER> button.
- 4) The name should be displayed.

If necessary, turn the <MENU/VOL> dial to select the correct name.

- 5) Press the <ENTER> or ☎ (phone) button in order to dial the number.

Calling via voice tag:

If your mobile phone supports voice recognition, it is possible to make a call via the voice tag instead of manual selection, provided the name and number of your contact has been previously marked and stored in the phone book of your mobile phone. For details, see the mobile phone manufacturer's owner's manual.

In order to dial via a voice tag, proceed as follows:

- 1) Press the ☎ (phone) button for more than 2 seconds.
- 2) The display shows [SPEAK NOW].
- 3) Give your voice tag.
Say the voice tag clearly and normally in the direction of the microphone (located in ceiling in front of the rear view mirror).
- 4) If the voice tag is correct, the phone system will dial the corresponding number.

Make a call via speed dial:

To make a speed dial call using one of the assigned preset buttons, proceed as follows:

- 1) Press the ☎ (phone) button briefly.
- 2) Press the corresponding preset button (1–6).

Alternatively, you can select the corresponding preset number by turning the <MENU/VOL> dial instead of pressing the preset button.

Receiving a call

When receiving an incoming call, the display will show the caller identification (or [NO NUMBER]) and you can:

- answer the call by pressing briefly on the ☎ (phone) button.
- end the call after the conversation by pressing the BACK button.
- reject the call by pressing the BACK button.

Steering wheel switch (where fitted)

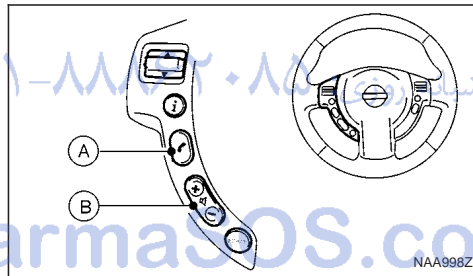

- (A) Telephone button
- (B) Volume control buttons

The hands-free mode can be operated using the controls on the steering wheel.

Volume control buttons:

The volume control buttons allows you to adjust the volume of the speakers by pressing the + or – button.

Telephone button:

The phone (☎) button allows you to:

- accept an incoming call by pressing the phone (☎) button once.
- reject an incoming call when the phone (☎) button is pressed for more than 2 seconds during the incoming call.
- end an active call by pressing the phone (☎) button once.
- redial the last outgoing call by pressing the phone (☎) button twice.
- make a speed dial call by pressing the phone (☎) button then push the scrolling (up/down) switch to scroll through the preset buttons for the stored phone numbers. To confirm the selection press the phone (☎) button to make the call.
- make a call via voice dialling by pressing the phone (☎) button for more than 2 seconds then say the voice tag clearly.

MOBILE PHONE INTEGRATION FOR FM AM RADIO WITH CD PLAYER

BLUETOOTH® MOBILE PHONE FEATURE

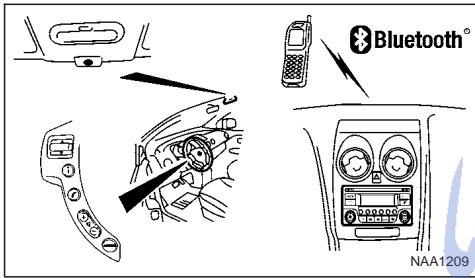

WARNING

Whilst driving, using the mobile phone is extremely dangerous because it significantly impairs your concentration and diminishes your reaction capabilities to sudden changes on the road, and it may lead to a fatal accident. This applies to all phone call situations such as when receiving an incoming call, during a phone conversation, when calling through the phone book search, etc.

CAUTION

Certain country jurisdictions prohibit the use of the mobile phone in the car without hands-free support.

This chapter provides information about the NISSAN hands-free phone system using a Bluetooth® connection.

Bluetooth® is a wireless radio communication standard. This system offers a hands-free facility for your mobile telephone to enhance driving comfort.

NOTE

For models with NISSAN Connect system, see the separately provided Owner's Manual.

In order to use your mobile phone with the Bluetooth® of the audio system, the mobile phone must first be setup. For details, see "BLUETOOTH® settings" later in this section. Once it has been setup, the hands-free mode is automatically activated on the registered mobile phone (via Bluetooth®) when it comes into range.

A notification message appears on the audio display when the phone is connected, when an incoming call is being received, as well as when a call is initiated.

When a call is active, the audio system, microphone (located in the ceiling in front of the rear view mirror), and steering wheel switches enable hands-free communication.

If the audio system is in use at the time, the radio, CD, or AUX source mode will be muted and will stay muted until the active call has ended.

The Bluetooth® system may not be able to connect with your mobile phone for the following reasons:

- The mobile phone is too far away from the vehicle.

- The Bluetooth® mode on your mobile phone has not been activated.
- Your mobile phone has not been paired with the Bluetooth® system of the audio unit.
- The mobile phone does not support Bluetooth® technology (BT Core v2.0).

NOTE

- For models with NISSAN Connect (Audio with Navigation system) see the separately provided Owner's Manual.
- For details, see your mobile phone's Owner's Manual.
- For assistance with your mobile phone integration, please visit your local NISSAN dealer.

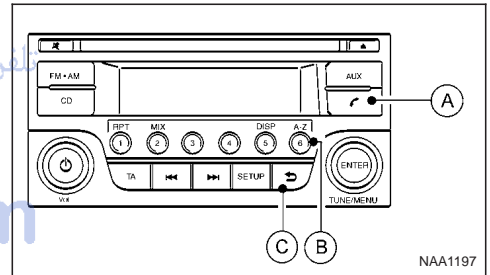

- (A) Phone button
- (B) Phone book quick search button
- (C)  (Back) button

BLUETOOTH® settings

To setup the Bluetooth system to pair (connect or register) your preferred mobile phone, push the <SETUP> button, select the [Bluetooth] key, and then push the <ENTER> button. It is also possible to enter the setup menu directly via the <☎> (phone) button.

The following options can be selected:

- [Pair Device]

Bluetooth mobile phones can be paired with the system. A maximum of 5 Bluetooth mobile phones can be registered.

- [Select Device]

Paired Bluetooth mobile phones (☎) are listed on the display and can be selected for connection.

- [Delete Device]

A registered Bluetooth mobile phone can be deleted.

- [On]/[Off]

If this setting is turned off, the connection between the Bluetooth devices and the in-vehicle Bluetooth module will be cancelled.

For details, see "BLUETOOTH® settings" earlier in this section.

When successfully paired, a notification message will be displayed. During the connection the following status icons will be displayed (top left of dis-

play): Signal strength (📶), Battery status (🔋), and Bluetooth (☎).

*: If the low battery message comes on, the Bluetooth® device must be recharged soon.

HANDS-FREE TELEPHONE CONTROL

The hands-free mode can be operated using the telephone <☎> button on the audio system, or (where fitted) on the steering wheel.

Initiating a call

A call can be initiated using one of the following methods:

- Redial
- Phone book
- Manual dialling
- Missed calls
- Dialed calls
- Received calls

Redial:

To redial or call the last number dialled, press <☎> for more than 2 seconds.

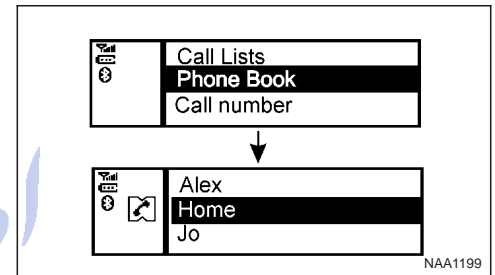

Making a call from the phone book:

Once the Bluetooth® connection has been made, between the registered mobile phone and the audio system, phone book data will be transferred automatically to the audio system. The transfer may take a while before completion.

NOTE

Phone book data will be erased when:



- Switching to another registered mobile phone.
- Mobile phone is disconnected.
- The registered mobile phone is deleted from the audio system.

1. Press <☎>.

2. Turn the <TUNE/MENU> dial and scroll down to [Phone Book] then press <ENTER>.

3. Scroll down through the list, select the appropriate contact name (highlighted), and press <ENTER>.

4. A following screen will show the number to be dialled. If correct, press <ENTER> again to dial the number.

If the contact has more numbers assigned for  (home),  (mobile), or  (office), scroll, and select the appropriate number to dial.

Alternatively, the quick search mode can be used as follows:

1. Press <A-Z/>.

2. Turn the <TUNE/MENU> dial for the first alphabetic or numerical letter of the contact name. Once highlighted, press <ENTER> to select the letter.

3. The display will show the corresponding contact name(s). Where necessary, use the <TUNE/MENU> dial again to scroll further for the appropriate contact name to call.

4. A following screen will show the number to be dialled. If correct, press <ENTER> again to dial the number.

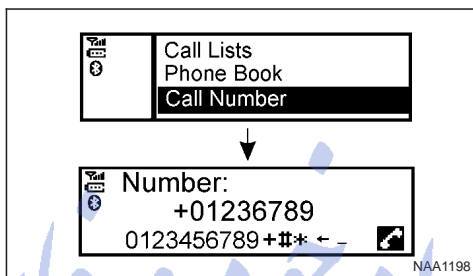

Manually dialling a phone number:



WARNING

Park the vehicle in a safe location, and apply the handbrake before making a call.

To dial a phone number manually use the audio system display (virtual keyboard pad) as follows:

1. Press <F>, and turn the <TUNE/MENU> dial to highlight [Call Number].

2. Press <ENTER> to select [Call Number].

3. Turn the <TUNE/MENU> dial to scroll along, and select each number of the phone number. Once highlighted, press <ENTER> after each number selection.

To delete the last number entered scroll to the [←] (Backspace) symbol, and once highlighted press <ENTER>. The last number will be deleted. Pressing <ENTER> repeatedly will delete each subsequent number.

4. After entering the last number, scroll to the [] symbol, and press <ENTER>, or press <F> to dial the number.

Call Lists:

A number from the dialled, received, or missed call lists can also be used to make a call.

● Dialled call

Use the dialled call mode to make a call which is based on the list of outgoing (dialled) calls.

● Received call

Use the received call mode to make a call which is based on the list of received calls.

● Missed call

Use the missed call mode to make a call which is based on the list of missed calls.

1. Press <F>, and select [Call Lists].

2. Turn the <TUNE/MENU> dial to scroll to an item, and press <ENTER> to select it.

3. Scroll to the preferred phone number then press <ENTER>, or press <F> to dial the number.

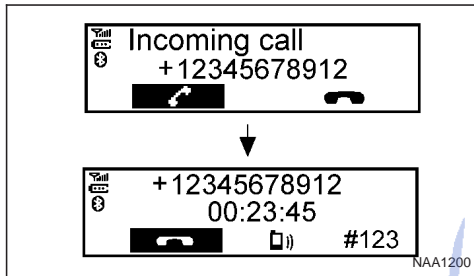

- [#123] — Use this item to enter numbers during a call. For example, if directed by an automated phone system to dial an extension number the system will send the tone associated with the selected number.
- [☎] — Use this item (the transfer handset command) to transfer the call from the audio system to your mobile phone.
To transfer the call back to hands-free via the audio system select [📞].

STEERING WHEEL SWITCHES (where fitted)

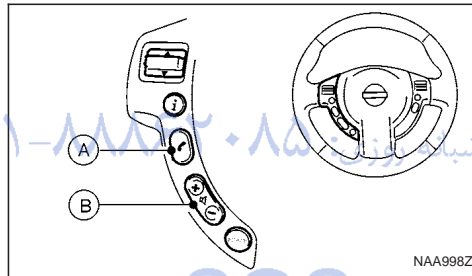

- Ⓐ Telephone button
- Ⓑ Volume control buttons

The hands-free mode can be operated using the steering wheel switches.

Volume control buttons

The volume control buttons allow you to adjust the volume of the speakers by pressing the <+> or <-> button.

Telephone button

The phone <☎> button allows you to:

- Accept an incoming call by pressing <☎> once.
- Reject an incoming call by pressing <☎> for more than 2 seconds during the incoming call.
- End an active call by pressing the <☎> button once.
- Redial the last outgoing call by pressing the <☎> button for more than 2 seconds.

Receiving a call

When receiving an incoming call, the display will show the caller's phone number (or a notification message that the caller's phone number cannot be shown):

- Answer the call by pressing <☎> briefly, or press <ENTER>.
- End the call, after the conversation, by:
 - Pressing <☎> briefly again.
 - Pressing <ENTER> when the [📞] symbol is highlighted.
If [📞] is not highlighted, turn the <TUNE/MENU> dial to [📞], and press <ENTER>.
- Reject the call by pressing <☎> with a long press or select [📞] from the incoming call screen.

During a call:

During a call, by scrolling and pressing <ENTER>, you can select the following options:

5 Starting and driving

Running-in schedule	5-2	Emergency key – Intelligent Key dead battery situation	5-10
Before starting the engine	5-2	NISSAN Anti-Theft System (NATS)	5-10
Precautions when starting and driving	5-3	Starting the engine	5-11
Exhaust gas (Carbon Monoxide)	5-3	Driving the vehicle	5-12
On-pavement and off-road driving precautions	5-4	Driving with manual transmission	5-12
Three-way catalyst (Petrol engine models)	5-4	Driving with automatic transmission or with continuously variable transmission (Models with manual shift)	5-14
To help prevent damage	5-4	Driving with Continuously Variable Transmission (CVT) (Models without manual shift)	5-17
Turbocharger system (Diesel engine models)	5-5	Stop/Start System (where fitted)	5-21
Diesel Particulate Filter (DPF) (where fitted)	5-5	Normal operation	5-21
Regeneration restrictions	5-5	Precautions	5-22
If regeneration fails	5-5	Stop/Start System OFF switch	5-23
Care when driving	5-6	Environmental savings	5-23
Engine cold start period	5-6	Ultrasonic Parking Sensor (where fitted)	5-24
Loading luggage	5-6	Four-wheel Drive (4WD) (where fitted)	5-24
Driving on wet roads	5-6	4WD mode operations	5-25
Driving under winter conditions	5-6	4WD shift tips	5-25
Ignition switch	5-6	4WD Warning light	5-26
Manual transmission	5-6	4WD Mode indicator lights	5-27
Automatic transmission or Continuously variable transmission	5-7	Driving four-wheel drive (4WD) safely	5-27
Steering lock	5-7	Cruise control (where fitted)	5-29
Key positions	5-7	Precautions on cruise control	5-29
NISSAN Anti-Theft System (NATS)	5-7	Cruise control system operations	5-30
Ignition knob (where fitted)	5-8	Speed limiter	5-31
Manual transmission	5-8	Speed limiter operations	5-32
Automatic transmission or Continuously variable transmission	5-9	Parking	5-33
Steering lock	5-9	Trailer towing	5-35
Ignition knob position	5-9		

Operating precautions	5-35	Electronic Stability Programme (ESP) system (where fitted)	5-40
Tyre pressure	5-36	Electronic Stability Programme (ESP) OFF switch.....	5-42
Safety chains.....	5-36	Cold weather driving.....	5-42
Trailer brakes.....	5-36	Battery	5-43
Trailer detection (where fitted)	5-36	Engine coolant.....	5-43
Installation of coupling device	5-36	Tyre equipment.....	5-43
Vehicle security.....	5-38	Special winter equipment.....	5-43
Power steering system.....	5-38	Corrosion protection.....	5-43
Brake system.....	5-39		
Brake precautions	5-39		
Anti-lock Braking System (ABS).....	5-39		

امداد خودرو فارما

تلفن شبانه روزی: ۰۸۵ ۰۸۸۶۲ ۰۲۱

FarmaSOS.com

RUNNING-IN SCHEDULE

During the first 1,600 km (1,000 miles), follow these recommendations for the future reliability and economy of your new vehicle. Failure to follow the recommendations may result in shortened engine life and reduced engine performance.

- Avoid driving for long periods at a constant speed, either fast or slow.
- Do not accelerate at full throttle in any gear.
- Avoid quick starts.
- Avoid hard braking as much as possible.
- Do not tow a trailer during the first 800 km (500 miles).

NOTE

Models with K9K diesel engine will achieve top performance only after approximately 5,000 km (3,000 miles).

BEFORE STARTING THE ENGINE



WARNING

The driving characteristics of your vehicle can be changed remarkably by any additional load and its distribution as well as by adding optional equipment (trailer couplings, roof racks, etc.). Your driving style and speed have to be adjusted accordingly. Especially when carrying heavy loads, your speed must be reduced adequately.

- Make sure the area around the vehicle is free of obstacles.
- Check fluid levels such as engine oil, coolant, brake and clutch fluid, and window washer fluid as frequently as possible, at least whenever you refuel.
- Visually inspect tyres for their appearance and condition. Also check the tyre pressure for proper inflation.
- Maintenance items in the "8. Maintenance and do-it-yourself" section should be checked periodically.
- Check that all windows and light lenses are clean.
- Check that all doors are closed.
- Position the seat and adjust the head restraints.
- Adjust the inside and outside mirrors.
- Fasten your seat belt and ask all passengers to do likewise.

- Check the operation of the warning/indicator lights when the ignition switch is turned to the ON position.
- Do not place hard or heavy objects on the dashboard or rear parcel shelf in order to prevent injury in the event of a sudden stop.

5-2 Starting and driving



PRECAUTIONS WHEN STARTING AND DRIVING



WARNING

- Do not leave children or adults who would normally require the support of others alone in your vehicle. Pets should also not be left alone. They could accidentally injure themselves or others through inadvertent operation of the vehicle. Also, on hot, sunny days, temperatures in a closed vehicle could quickly become high enough to cause severe or possibly fatal injuries to people or animals.
- To prevent luggage or packages from sliding forward during braking, do not stack anything in the cargo area higher than the seatbacks.
- Secure all cargo with ropes or straps to prevent it from sliding or shifting.
- Failure to follow proper seating instructions see "Seats" in the "1. Safety — seats, seat belts and supplemental restraint system" section, could result in serious personal injury in an accident or sudden stop.

EXHAUST GAS (Carbon Monoxide)



WARNING

- Do not breathe exhaust gases; they contain colourless and odourless carbon monoxide. Carbon monoxide is a dangerous gas and can cause unconsciousness or death.

- If you suspect that exhaust fumes are entering the vehicle, drive with all windows fully open and have the vehicle inspected immediately.
- Do not run the engine in closed spaces, such as a garage, for any longer than is absolutely necessary.
- Do not park the vehicle with the engine running for any extended length of time.
- Keep the back door closed while driving, otherwise exhaust gases could be drawn into the passenger compartment. If you must drive in this way for some reason, take the following steps:
 - 1) Open all the windows.
 - 2) Set the air recirculation mode (☞) to the "OFF" position.
 - 3) Set the fan speed control to the maximum position to circulate the air.
- If electrical wiring or other cable connections must pass to a trailer through the seal of the body, follow the manufacturer's recommendations to prevent carbon monoxide entry into the vehicle.
- When a vehicle has been stopped in an open area with its engine running for any significant length of time, turn the fan on to force outside air into the vehicle.

- The exhaust system and body should be inspected by a NISSAN dealer or qualified workshop whenever:
 - the vehicle is raised for service.
 - you suspect that exhaust fumes are entering into the passenger compartment.
 - you notice a change in the sound of the exhaust system.
 - you have had an accident involving damage to the exhaust system, underbody, or rear of the vehicle.

ON-PAVEMENT AND OFF-ROAD DRIVING PRECAUTIONS

Utility vehicles have a significantly higher rollover rate than other types of vehicles.

They have higher ground clearance than passenger cars to make them capable of performing in a wide variety of on-pavement and off-road applications. This gives them a higher centre of gravity than ordinary cars. An advantage of higher ground clearance is a better view of the road, allowing you to anticipate problems. However, they are not designed for cornering at the same speeds as conventional two-wheel drive (2WD) vehicles any more than low-slung sports cars are designed to perform satisfactorily under off-road conditions. If possible, avoid sharp turns or abrupt manoeuvres, particularly at high speeds. As with other vehicles of this type, failure to operate this vehicle correctly may result in loss of control or vehicle rollover. In a rollover accident an unbelted person is significantly more likely to be injured than a person who is wearing a seat belt.

THREE-WAY CATALYST (Petrol engine models)

NISSAN GREEN PROGRAM

The three-way catalyst is an emission control device installed in the exhaust system. In the converter, exhaust gases are burned at high temperatures to help reduce pollutants.

CAUTION

- The exhaust gas and the exhaust system are very hot. While the engine is running, keep people or flammable materials away from the exhaust pipe.
- Do not stop or park the vehicle over flammable materials such as dry grass, waste paper or rags, as they may burn easily.
- When parking, ensure that people or flammable materials are kept away from the exhaust pipe.

TO HELP PREVENT DAMAGE

CAUTION

- Use UNLEADED PETROL ONLY, specifically the recommended type. For details, see "Capacities and recommended fuel/lubricants" in the "9. Technical information" section.
- Do not use leaded petrol. Leaded petrol will seriously damage three-way catalyst.

Deposits from leaded petrol will seriously reduce the three-way catalyst's ability to help reduce exhaust pollutants.

- Keep your engine tuned up. Malfunctions in the ignition, fuel injection, or electrical systems can cause over-rich fuel flow into the converter, causing it to overheat.
- Avoid driving with an extremely low fuel level. Running out of fuel could cause the engine to misfire, damaging the three-way catalyst.
- Do not keep driving if the engine misfires, or if noticeable loss of performance or other unusual operating conditions are detected. Have the vehicle inspected promptly by a NISSAN dealer or qualified workshop.
- Do not race the engine while warming it up.
- Do not push or tow your vehicle to start the engine.

5-4 Starting and driving



TURBOCHARGER SYSTEM (Diesel engine models)

The turbocharger system uses engine oil for lubrication and cooling of its rotating components. The turbocharger turbine turns at extremely high speeds and it can reach an extremely high temperature. It is essential to maintain a flow of clean oil through the turbocharger system. A sudden interruption to the oil supply may cause a malfunction in the turbocharger.

To ensure prolonged life and performance of the turbocharger, it is essential to comply with the following maintenance procedure:

CAUTION

- **Change the engine oil of the turbo-charged diesel engine as prescribed. See the separately provided Warranty Information & Maintenance Booklet for additional information.**
- **Use only the recommended engine oil. See “Capacities and recommended fuel/lubricants” in the “9. Technical information” section.**
- **If the engine has been operating at high rpm for an extended period of time, let it idle for a few minutes prior to shutdown.**
- **Do not accelerate the engine to high rpm immediately after starting it.**

DIESEL PARTICULATE FILTER (DPF) (where fitted)



WARNING

- **Be careful not to burn yourself with exhaust gases.**
- **Do not park the vehicle over flammable materials such as dry grass, waste paper or rags, as they may burn easily.**
- **If the vehicle continues to be driven at a low speed with the DPF warning light illuminated, the fail-safe will limit engine revolutions and/or torque. In this case, the engine oil must be replaced and the process of burning accumulated particulate matter must be carried out by a NISSAN dealer or qualified workshop. Service regeneration is a maintenance item and is not covered by the NISSAN warranty.**
- **Use engine oil for DPF equipped models. For details, see “Capacities and recommended fuel/lubricants” in the “9. Technical information” section.**

CAUTION

The DPF becomes extremely hot after burning particulate matter.



NISSAN GREEN PROGRAM

Some diesel engine models are fitted with a Diesel Particulate Filter (DPF), which is a device that removes carbon (soot) from the exhaust gas. To operate effectively, the DPF system must routinely conduct a cleaning operation, called regeneration, that



burns-off the accumulated carbon. This regeneration process is normally automatic and not visible to the driver.

REGENERATION RESTRICTIONS

Driving conditions such as frequent short journeys or stop/start driving can result in excessive build up of carbon in the filter. When this happens the DPF warning light  will illuminate (and a message will appear in the vehicle information display, see “Vehicle information display” later in this section) to inform you that the vehicle must be driven in a particular manner to begin regeneration.

When the DPF warning light is illuminated, provided that legal and safety conditions allow, the vehicle should be driven at a speed of over 60 km/h (37.5 MPH) until the DPF warning light turns off. This process can take up to 30 minutes to complete.

IF REGENERATION FAILS

Failure to react to the DPF warning light  may lead to saturation of the DPF system. If this happens, the Malfunction Indicator (MI)  will also illuminate to indicate that a Service Regeneration by a NISSAN dealer or qualified workshop is required. The engine speed may also be limited to 3,000 rpm to protect the DPF system.

NOTE

Contact a NISSAN dealer or qualified workshop to perform a forced regeneration.

CARE WHEN DRIVING

Driving your vehicle to fit the circumstances is essential for your safety and comfort. As a driver, you should be the one who knows best how to drive in the given circumstances.

ENGINE COLD START PERIOD

Due to the higher engine speeds when the engine is cold, extra caution must be exercised when selecting a gear during the engine warm-up period after starting the engine.

LOADING LUGGAGE

Loads, their distribution and the attachment of equipment (coupling devices, roof luggage carriers, etc.) will change the driving characteristics of the vehicle considerably. Driving style and speed must be adjusted accordingly.

DRIVING ON WET ROADS

- Avoid starting off, accelerating and stopping suddenly.
- Avoid sharp turns or lane changes.
- Extra distance should be kept from the vehicle in front.
- When water covers the road surface in puddles, small streams, etc, **REDUCE SPEED** to prevent aquaplaning which will cause skidding and loss of control. Worn tyres increase this risk.

DRIVING UNDER WINTER CONDITIONS

- Drive safely.
- Avoid starting off, accelerating or stopping suddenly.
- Avoid sharp turns or lane changes.
- Avoid sudden steering actions.
- Extra distance should be kept from the vehicle in front.

IGNITION SWITCH

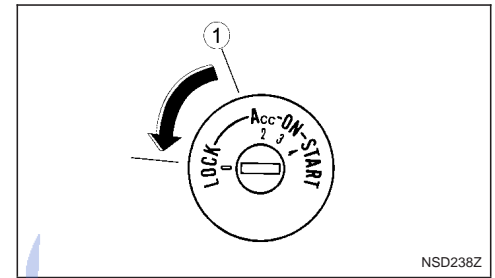

① OFF



WARNING

Never remove the key or turn the ignition switch to the **LOCK** position while driving. The steering wheel will lock and could cause the driver to lose control of the vehicle. This could result in serious vehicle damage or personal injury.

The switch includes an anti-theft steering lock device.

There is an "OFF" position between the LOCK and Acc positions, although it is not shown on the lock cylinder. When the ignition switch is in the "OFF" position, the steering wheel is not locked.

MANUAL TRANSMISSION

To lock the steering wheel, turn the ignition switch to the LOCK position and remove the key from the ignition switch, then turn the steering clockwise. To



unlock the steering wheel, insert the ignition key and turn it gently while rotating the steering wheel slightly right and left.

The ignition key can only be removed when the switch is in the LOCK position (Normal parking position) (0).

AUTOMATIC TRANSMISSION OR CONTINUOUSLY VARIABLE TRANSMISSION

On Automatic Transmission (AT) or Continuously Variable Transmission (CVT) models, the ignition lock is designed so that the key cannot be turned to LOCK and removed until the selector lever is moved to the P (Park) position.

When removing the key from the LOCK position of the ignition switch, make sure that the selector lever is in the P (Park) position.

The selector lever can only be moved from the P (Park) position when the ignition switch is in the ON position and the footbrake pedal is depressed.

To remove the key from the ignition switch:

1. Move the selector lever into the P (Park) position.
2. Turn the key to the LOCK position.
3. Remove the key from the ignition switch.

If the key is removed from the ignition switch, the selector lever cannot be moved from the P (Park) position.

When the key cannot be turned toward the LOCK position, proceed as follows to remove the key:

1. Move the selector lever into the P (Park) position.
2. Turn the key slightly in the ON direction.
3. Turn the key towards the LOCK position.
4. Remove the key.

STEERING LOCK

To lock the steering wheel

1. Turn the key to the LOCK position.
2. Remove the key from the ignition switch.
3. Turn the steering wheel 1/6 of a turn clockwise from the straight up position.

To unlock the steering wheel

1. Insert the key into the ignition switch.
2. Gently turn the key while rotating the steering wheel slightly right and left.

KEY POSITIONS

LOCK (Normal parking position) (0)

The ignition key can only be removed when in this position.

The steering lock can only be locked in this position.

“OFF” (1)

The engine is turned off without locking the steering wheel.

Acc (Accessories) (2)

This position activates electrical accessories, such as the radio, when the engine is not running.

ON (Normal operating position) (3)

This position turns on the ignition system and electrical accessories.

START (4)

The engine starter activates and the engine will start. As soon as the engine has started, release the key immediately. It will return to the ON position.

NOTE

For vehicles fitted with Stop/Start System:

When the engine is automatically stopped by the Stop/Start System the ignition switch can still be operated as usual.

At the end of a journey turn the ignition OFF to avoid a flat battery. The Stop/Start System does not automatically turn ignition off.

NISSAN ANTI-THEFT SYSTEM (NATS)

The NISSAN Anti Theft System (NATS)* will stop the engine if someone tries to start the engine without using the registered NATS key.

* Immobilizer

If you failed to start the engine using the NATS Key, turn the ignition knob to the LOCK position, wait for 5 seconds and turn the key to the START position again to start the engine.

IGNITION KNOB (where fitted)

For additional information, see "NISSAN Anti-Theft System (NATS)" in the "3. Pre-driving checks and adjustments" section.

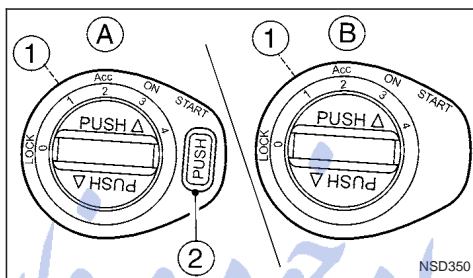

- (A) MT models
- (B) AT/CVT models
- ① OFF
- ② PUSH release button



WARNING

Never turn the ignition knob to the LOCK position while driving as the steering wheel will lock. This may cause the driver to lose control of the vehicle and could result in serious damage to the vehicle or personal injury.

The ignition knob includes an anti-theft steering lock device.

There is an "OFF" position between the LOCK and Acc positions, although it is not shown on the lock cylinder. When the ignition knob is in the "OFF" position, the steering wheel is not locked.

CAUTION

- Make sure you carry the Intelligent Key with you when operating the vehicle.
- Never leave the Intelligent Key inside the vehicle when you leave the vehicle.
- If the Intelligent Key is too far away from the driver, the vehicle may not start.

MANUAL TRANSMISSION

The ignition lock is designed so that the knob can ONLY be turned to the LOCK position when the PUSH release button has first been depressed.

NOTE

- The ignition knob warning appears in the vehicle information display and the buzzer sounds twice when the ignition knob is turned to the "OFF" position. Depress the PUSH release button ②, then turn the ignition knob to the LOCK position. See "Ignition knob warning (Intelligent Key models)" in the "2. Instruments and controls" section for further details regarding the functionality of the ignition knob warning.
- When the emergency key is being used, the PUSH release button ② must be depressed in order to turn the ignition knob to the LOCK position although the ignition knob warning will not appear and the buzzer will not sound.

AUTOMATIC TRANSMISSION OR CONTINUOUSLY VARIABLE TRANSMISSION

The ignition knob is designed so that it cannot be turned to the LOCK position until the selector lever is moved to the P (Park) position. The selector lever can only be moved from the P (Park) position when the ignition knob is in the ON position and the footbrake pedal is depressed.

NOTE

The ignition knob warning appears and a buzzer sounds twice when the ignition knob is turned to the "OFF" position. Make sure that the selector lever is in the P (Park) position, then turn the ignition knob to the LOCK position. See "Warnings and alerts" in the "2. Instruments and controls" section for further details regarding the functionality of the ignition knob warning.

STEERING LOCK

To lock the steering wheel

In the LOCK position, turn the steering wheel 1/6 of a turn from the straight up position.

To unlock the steering wheel

Depress the brake pedal, push the ignition knob and turn it towards the Acc position while gently rotating the steering wheel right or left.

IGNITION KNOB POSITION

LOCK (Normal parking position) (0)

The steering lock can only be locked in this position.

"OFF" (1)

The engine can be turned off without locking the steering wheel.

Acc (Accessories) (2)

This position activates electrical accessories, such as the radio, when the engine is not running.

ON (Normal operating position) (3)

This position turns on the ignition system and the electrical accessories.

START (4)

The engine starter activates and the engine will start. As soon as the engine has started, release the knob immediately. It will return to the ON position.

NOTE

For vehicles fitted with Stop/Start System:

When the engine is automatically stopped by the Stop/Start System the ignition knob can still be operated as usual.

At the end of a journey turn the ignition OFF to avoid a flat battery. The Stop/Start System does not automatically turn ignition off.

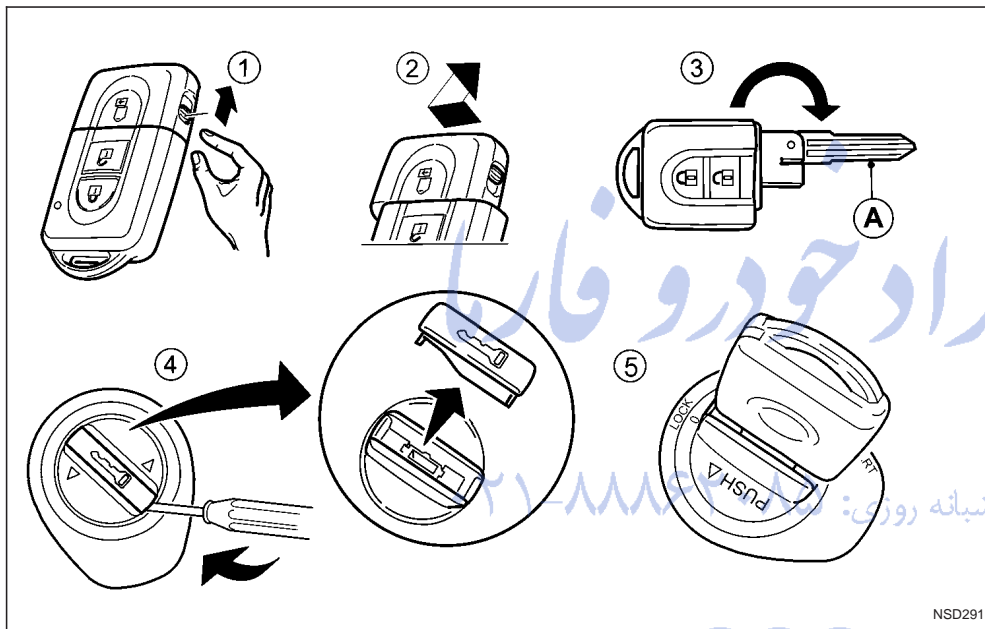

EMERGENCY KEY – INTELLIGENT KEY DEAD BATTERY SITUATION

- ① Slide the locking pin to the unlock position.
- ② Remove the Intelligent Key cap as illustrated.
- ③ Unfold the key (A).

- ④ Remove the ignition knob key slot cap with a suitable tool.
- ⑤ Insert the emergency key (A) into the ignition switch as illustrated.
- ⑥ Proceed with the emergency key as described in "Ignition switch" earlier in this section.

On **AT or CVT models**, when the ignition knob cannot be turned to the LOCK position, proceed as follows:

- ① Slide the locking pin to the unlock position.
- ② Remove the Intelligent Key cap as illustrated.
- ③ Unfold the key (A).
- ④ Remove the ignition knob key slot cap with a suitable tool.
- ⑤ Insert the emergency key (A) into the ignition switch as illustrated.
- ⑥ Move the selector lever to the P (Park) position.
- ⑦ Turn the emergency key slightly in the ON direction.
- ⑧ Turn the emergency key to the LOCK position.
- ⑨ Remove the emergency key.

If the key is removed from the ignition switch, the selector lever cannot be moved from P (Park). **The selector lever can only be moved from the P (Park) position when the ignition knob is in the ON position and the footbrake pedal is depressed.**

NISSAN ANTI-THEFT SYSTEM (NATS)

The NISSAN Anti-Theft System (NATS)* will stop the engine if someone tries to start the engine without the registered Intelligent Key.

* Immobilizer



STARTING THE ENGINE

If you failed to start the engine using the NATS Intelligent Key, turn the ignition knob to the LOCK position, wait for 5 seconds and turn the knob to the START position again to start the engine.

For additional information, see "NISSAN Anti-Theft System (NATS)" in the "3. Pre-driving checks and adjustments" section.

1. Apply the handbrake.

2. **Manual transmission models:**

Move the gear lever to N (Neutral) position, and depress the clutch pedal to the floor while starting the engine.

Automatic transmission or Continuously variable transmission models:

Depress the brake pedal and move the selector lever to the P (Park) or N (Neutral) position. (P position is preferred).

NOTE

The starter is designed not to operate if the selector lever is out of the P (Park) or N (Neutral) position.

3. Models without Intelligent Key:

Rotate the steering wheel left to right to release the ignition lock whilst turning the ignition switch to the ON position.

Models with Intelligent key:

- MT models – keep the clutch pedal depressed and/or depress the brake pedal then:

- AT or CVT models – depress the brake pedal then:

1) Push the ignition knob.

2) Rotate the steering wheel left to right to release the ignition lock whilst turning the ignition knob to the ON position.

CAUTION

- **Make sure you carry the Intelligent Key with you when operating the vehicle.**

- **If the Intelligent Key is too far away from the driver, the vehicle may not start.**

4. For diesel engine models: Wait until the glow indicator light  goes out.

5. Crank the engine with your foot on the brake pedal, **not on the accelerator pedal**, by turning the ignition switch to START.

6. Release the ignition switch when the engine starts. If the engine starts, but fails to run, repeat the above procedure.

For petrol engine models:

NOTE

Models with HR16DE engine:

If the engine is very hard to start because it is flooded, depress the accelerator pedal all the way to the floor and hold it. Crank the engine for 5-6 seconds and stop. After cranking the engine, release the accelerator pedal. Then crank the engine with your foot off the accelerator pedal. Release the ignition switch when the engine starts. If the engine starts, but fails to run, repeat the above procedure.

Models with MR20DE engine:

If the engine is very hard to start in extremely cold or hot weather, or when restarting, depress the accelerator pedal a little (approxi-

DRIVING THE VEHICLE

mately 1/3 to the floor) and hold it then crank the engine. Release the ignition switch and the accelerator pedal when the engine starts.

CAUTION

- Do not operate the starter for more than 15 seconds at a time. If the engine does not start, turn the ignition switch to the "OFF" position and wait 10 seconds (Petrol engine models) or 20 seconds (Diesel engine models) before cranking again, otherwise the starter could be damaged.
- If it becomes necessary to start the engine with a booster battery and jumper leads, the instructions and cautions contained in the "Jump-starting" in the "6. In case of emergency" section should be carefully followed.

7. Warm-up

Allow the engine to idle for at least 30 seconds after starting. Drive at moderate speed for a short distance first, especially in cold weather.

WARNING

Do not leave the vehicle unattended while the engine is warming up.

DRIVING WITH MANUAL TRANSMISSION

CAUTION

- Do not rest your foot on the clutch pedal while driving. This may cause clutch damage.
- Stop your vehicle completely before shifting into the R (Reverse) position.
- When you are shifting from one gear to another, be certain to depress the clutch pedal all the way to the floor to avoid clashing or chipping the gears.
- Avoid abrupt starts and acceleration for your safety.
- When quick acceleration is required for some reason, shift to a lower gear and accelerate until the vehicle reaches the maximum speed in each gear. Do not exceed the speed limit of any gear. Pay special attention when accelerating or when shifting into a lower gear on slippery surfaces. Sudden acceleration or down shifting could cause the wheels to skid and result in loss of control.

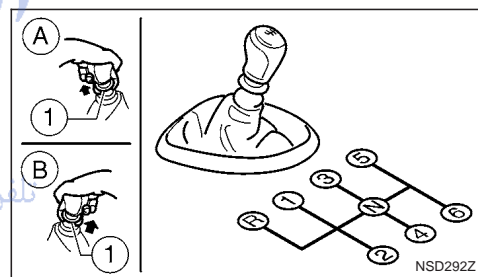
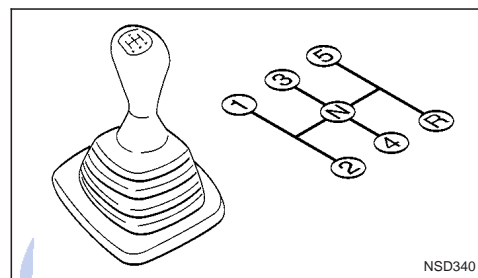

Shifting

- (A) RHD models
- (B) LHD models
- (1) Gear lever ring

To change gears, fully depress the clutch pedal, shift into the appropriate gear, then release the clutch slowly and smoothly.

To ensure smooth gear changes, fully depress the clutch pedal before operating the gear lever. If the clutch pedal is not fully depressed before the transmission is shifted, a gear noise may be heard. This could result in damage to the transmission.

Start the vehicle in 1st gear and shift through the gears in sequence according to the vehicle speed.

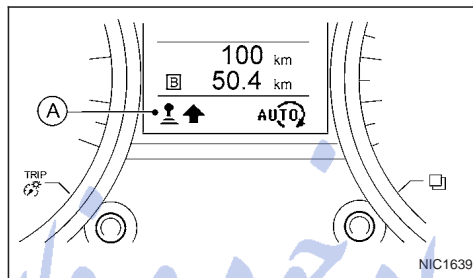

Model with Stop/Start System

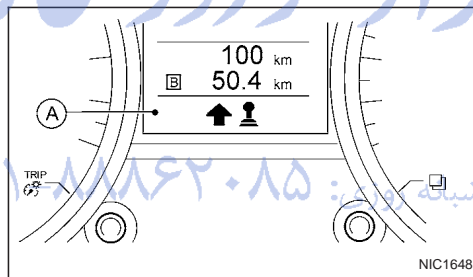

Model without Stop/Start System

Gear shift indicator (where fitted):

The gear shift indicator (A) located in the lower part of the vehicle information display can help to improve the level of environmentally friendly driving.

Following the gear shift indicator by changing to a higher (or lower) gear whenever the UP (or DOWN) arrow is displayed may improve fuel economy

An UP arrow suggests shifting to a higher gear, a down arrow suggests shifting to a lower gear.

However, the driver remains responsible for deciding the most suitable gear according to actual vehicle, road and traffic conditions.

NOTE

No arrow is displayed in some circumstances including:

- The actual gear matches recommended gear
- The vehicle speed is approx. 0 km/h

Reverse gear:

- To reverse with 5-speed manual transmission, stop the vehicle and shift the gear lever into the N (Neutral) position then to the R (Reverse) position.
- To reverse with 6-speed manual transmission, proceed as follows:
 - 1) Stop the vehicle.
 - 2) Move the gear lever into the N (Neutral) position.
 - 3) Pull and hold the gear lever ring ① up.
 - 4) Move the gear lever into the R (Reverse) position.
 - 5) Release the gear lever ring and safely drive the vehicle backwards.

The gear lever ring returns to its original position when the gear lever is moved to the N (Neutral) position.

When the gear lever is in the R (Reverse) position, either the NISSAN Connect monitor (where fitted)

or the ultra sonic parking sensor (where fitted) will be activated. For details, see "Rear-view monitor (where fitted)" in the "4. Display screen, heater and air conditioner, and audio system" section, "Around view monitor (where fitted)" in the "4. Display screen, heater and air conditioner, and audio system" section or "Ultrasonic Parking Sensor (where fitted)" later in this section.

If it is difficult to move the gear lever into R (Reverse) or 1st. Shift into N (Neutral), then release the clutch pedal. Fully depress the clutch pedal again and shift into R (Reverse) or 1st.

DRIVING WITH AUTOMATIC TRANSMISSION OR WITH CONTINUOUSLY VARIABLE TRANSMISSION (Models with manual shift)

CAUTION

- The cold engine idle speed is high, so use caution when shifting into a forward or reverse gear before the engine has warmed up.
- Avoid revving up the engine while the vehicle is stopped. This could cause unexpected vehicle movement.

Driving precautions

- Never shift to P (Park) or R (Reverse) while the vehicle is moving, this could result in damage to the transmission.
- Start the engine in the P (Park) or N (Neutral) position. The engine will not start in any other

selector position. If it does, have your vehicle checked by a NISSAN dealer or qualified workshop.

- Do not depress the accelerator pedal while shifting from P (Park) or N (Neutral) to R (Reverse), D (Drive) or Manual shift modes position. Always depress the brake pedal until shifting is completed.
- On an uphill grade, do not hold the vehicle by depressing the accelerator pedal. The footbrake should be used for this purpose, in order to hold the vehicle in place and to prevent overheating of the transmission.
- Shift into the N (Neutral) position and apply the handbrake when at a standstill for longer than a short waiting period.
- Keep the engine at idling speed while shifting from the N (Neutral) position to any driving position.

CAUTION (when starting the vehicle):

● DEPRESS THE FOOTBRAKE PEDAL

When the engine is running, shifting the selector lever into the R (Reverse), D (Drive) or Manual shift mode position without depressing the brake pedal causes the vehicle to move slowly. Be sure the brake pedal is fully depressed and the vehicle is stopped, before shifting the selector lever.

● BE AWARE OF THE SELECTOR LEVER POSITION

Make sure that the selector lever is in the desired position. Use the D (Drive), or Manual shift mode to move forwards and the R (Reverse) to move backwards. Release the handbrake lever and the footbrake pedal, then depress the accelerator pedal to start the vehicle in motion and merge with traffic (avoid abrupt starting and spinning the wheels).

- Avoid revving up the engine while the vehicle is stopped, this could cause unexpected vehicle movement [if the selector lever is in the R (Reverse), D (Drive), or Manual shift mode position] or damage the engine [if the selector lever is in the N (Neutral) or P (Park) position].

● WARM THE ENGINE UP

Due to the higher idle speeds when the engine is cold, extra caution must be taken when shifting the selector lever into the driving position immediately after starting the engine.

● PARKING THE VEHICLE

Depress the footbrake pedal and, once the vehicle stops, move the selector lever into the P (Park) position, pull the handbrake lever and release the footbrake pedal.

Starting the vehicle

1. After starting the engine, fully depress the footbrake pedal before shifting the selector lever from P (Park) to R (Reverse), D (Drive) or Manual shift mode.



- Keep the footbrake pedal depressed and push the selector lever button to shift into a driving gear.
- Release the handbrake and footbrake, then gradually start the vehicle in motion by pressing the accelerator pedal.

The automatic transmission or continuously variable transmission is designed so that the footbrake pedal **MUST** be depressed before shifting from P (Park) to any drive position while the ignition switch is ON.

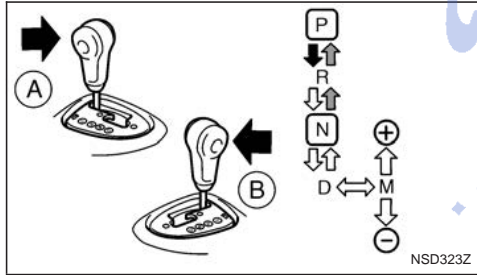

Shifting

- (A) LHD models
- (B) RHD models

To move the selector lever:

- ➔ Push the button while depressing the brake pedal.
- ➔ Push the button to shift.
- ➔ Shift without depressing the brake pedal.

Push the button to shift into P (Park) or R (Reverse). All other positions can be selected without pushing the button.

P (Park):

Use this position when the vehicle is parked or when starting the engine. Always make sure that the vehicle is completely stopped before moving the selector lever into the P (Park) position. For maximum safety, the footbrake pedal must be depressed before moving the selector lever into the P (Park) position. Use this position together with the handbrake. When parking on a hill, first depress the footbrake pedal, apply the handbrake and then shift into the P (Park) position.

R (Reverse):

CAUTION

Shift into this position only after the vehicle has completely stopped.

Use this position to reverse the vehicle.

When the selector lever is in the R (Reverse) position, either the NISSAN Connect monitor (where fitted) or the ultra sonic parking sensor (where fitted) will be activated. For details, see "Rear-view monitor (where fitted)" in the "4. Display screen, heater and air conditioner, and audio system" section.

and air conditioner, and audio system" section, "Around view monitor (where fitted)" in the "4. Display screen, heater and air conditioner, and audio system" section or "Ultrasonic Parking Sensor (where fitted)" later in this section.

N (Neutral):

Neither forward nor reverse gear is engaged. The engine can be started in this position. You may shift to N and restart a stalled engine while driving the vehicle.

D (Drive):

Use this position for all normal forward driving.

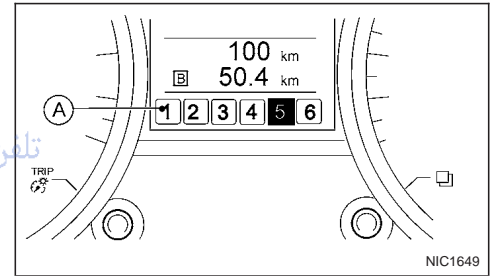

Gear shift indicator:

The gear shift indicator (A) located in the lower part of the vehicle information display shows the current position of the transmission.

It shows the P,R,N,D modes when the transmission is in auto mode. It shows the gear number when the transmission is in manual mode.

Manual shift mode

When the selector lever is shifted from D (Drive) to the manual shift gate with the vehicle stopped or while driving, the transmission enters manual shift mode. Shift range can be selected manually.

In manual shift mode, the selected gear is displayed on the position indicator in the combination meter.

Shift ranges up or down one by one as follows:

1st ⇌ 2nd ⇌ 3rd ⇌ 4th ⇌ 5th ⇌ 6th

- When shifting up, move the selector lever to the + (up) side. (Shifts to higher range).
- When shifting down, move the selector lever to the – (down) side. (Shifts to lower range).
- Moving the selector lever rapidly to the same side twice will shift the ranges in succession.
- Use the 1st position when driving slowly on steep hills, slow driving through deep snow, sand or mud, or for maximum engine braking on steep downhill grades.
- Use the 2nd, 3rd or 4th position when driving steep hills or for engine braking on steep downhill grades.
- Use the 5th position for driving up or down long slopes.
- Use the 6th position for all normal forward driving. However, you need to shift down the gears when accelerating or passing another vehicle.

- When cancelling manual shift mode, return the selector lever to the D (Drive) position. The transmission returns to the normal driving mode.
- **In manual shift mode, the transmission may not shift to the selected gear under certain circumstances. This helps maintain driving performance and reduces the chance of vehicle damage or loss of control.**
- **If the engine is revving up to a hazardous speed in manual shift mode, the transmission may shift up automatically. When the vehicle speed decreases, the transmission automatically shifts down and shifts to 1st gear before the vehicle comes to a stop.**

Accelerator downshift – In the D (Drive) position

For rapid passing or driving uphill, fully depress the accelerator pedal to the floor. This shifts the transmission down into a lower gear, depending on the vehicle speed.

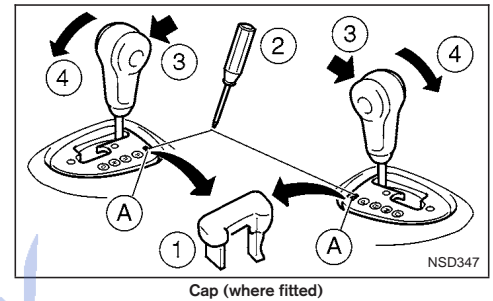

Shift lock release

If the battery is discharged, the selector lever cannot be moved from the P (Park) position even with the brake pedal depressed and the ignition switch in the ON position.

To move the selector lever, remove the cap (1) (where fitted) then push the shift lock release button (A) with a suitable tool (2) (as illustrated) and press the selector lever button (3). It is now possible to move the selector lever to the N (Neutral) position (4).

For your safety, make sure the handbrake is applied and the brake pedal is depressed during the operation.

If there is any problem moving the lever out of the P (Park) position, have a NISSAN dealer or qualified workshop to check the automatic transmission system as soon as possible.

Fail-safe

AT models:

When the fail-safe operation occurs, the AT CHECK indicator light comes on for 2 seconds and the automatic transmission will be locked in the third gear. Have a NISSAN dealer or qualified workshop check and repair the transmission.

CVT models:

When the fail-safe operation occurs, the vehicle speed will be decreased automatically to reduce the chance of transmission damage. Vehicle speed can be controlled with the accelerator pedal, but the engine power may be limited. Have a NISSAN dealer or qualified workshop check and repair the transmission.

AT or CVT models:

If the vehicle is driven under extreme conditions, such as excessive wheel spinning and subsequent hard braking, the Fail-safe system may be activated. This will occur even if all electrical circuits are functioning properly. In this case, turn the ignition switch "OFF" and wait for 10 seconds. Then turn the key back to the ON position. The vehicle should return to its normal operating condition. If it does not return to its normal operating condition have your NISSAN dealer or qualified workshop check the transmission and have the transmission repaired by a NISSAN dealer or qualified workshop, if necessary.



WARNING

When the fail safe operation occurs, the vehicle speed may be lower than other traffic, which could increase the chance of a collision. Be especially careful when driving. If necessary, drive to the side of the road at a safe place and away from traffic, to allow the transmission to return to normal operation, or have the transmission repaired by a NISSAN dealer or qualified workshop, if necessary.

DRIVING WITH CONTINUOUSLY VARIABLE TRANSMISSION (CVT) (Models without manual shift)

The Continuously Variable Transmission (CVT) in your vehicle is electronically controlled to produce maximum power and smooth operation.

The recommended operating procedures for this transmission are shown on the following pages. Follow these procedures for maximum vehicle performance and driving enjoyment.



WARNING

Do not downshift abruptly on slippery roads. This may cause a loss of control.

CAUTION

- The cold engine idle speed is high, so use caution when shifting the transmission into a forward or reverse position before the engine has warmed up.

- Avoid revving up the engine while the vehicle is stopped. This could cause unexpected vehicle movement.
- Never shift to either the P (Park) or R (Reverse) position while the vehicle is moving. This could cause serious damage to the transmission.
- Start the engine in either the P (Park) or N (Neutral) position. The engine will not start in any other position. If it does, have your vehicle checked by a NISSAN dealer or qualified workshop.
- Shift into the P (Park) position and apply the handbrake when at a standstill for longer than a short waiting period.
- Keep the engine at idling speed while shifting from the N (Neutral) position to any driving position.
- When stopping the vehicle on an uphill grade, do not hold the vehicle by depressing the accelerator pedal. The footbrake pedal should be depressed in this situation.

Starting vehicle

1. After starting the engine, fully depress the footbrake pedal before moving the selector lever out of the P (Park) position.
2. Keep the footbrake pedal depressed and move the selector lever to a driving position.
3. Release the handbrake, the footbrake pedal, and then gradually start the vehicle in motion.

The CVT is designed so the footbrake pedal **MUST** be depressed before shifting from the P (Park) position to any driving position while the ignition switch is in the ON position.

The selector lever cannot be moved out of the P (Park) position and into any of the other positions if the ignition switch is placed in the LOCK, "OFF" or ACC position or if the key is removed.

CAUTION

- **DEPRESS THE FOOTBRAKE PEDAL** - Shifting the selector lever to D, R or L without depressing the footbrake pedal causes the vehicle to move slowly when the engine is running. Make sure the footbrake pedal is depressed fully and the vehicle is stopped before shifting the selector lever.
- **MAKE SURE OF THE SELECTOR LEVER POSITION** - Make sure the selector lever is in the desired position. D and L are used to move forward and R to reverse.
- **WARM UP THE ENGINE** - Due to the higher idle speeds when the engine is cold, extra caution must be exercised when shifting the selector lever into the driving position immediately after starting the engine.

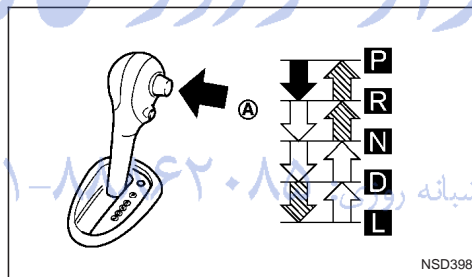
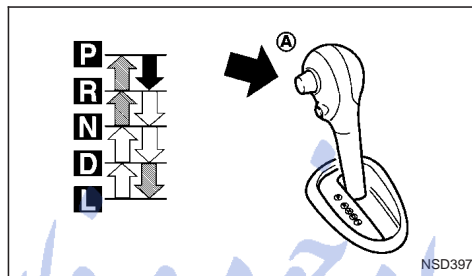

- ➔ Push the button (A) while depressing the footbrake pedal.
- ➔ Push the button (A).
- ➔ Just move the selector lever.

Shifting

! WARNING

- Apply the handbrake if the selector lever is in any position while the engine is not running. Failure to do so could cause the vehicle to move unexpectedly or roll away and result in serious personal injury or property damage.
- If the selector lever cannot be moved from the P (Park) position while the engine is running and the footbrake pedal is depressed, the stop lights may not work. Malfunctioning stop lights could cause an accident injuring yourself and others.

After starting the engine, fully depress the footbrake pedal, push the selector lever button and move the selector lever out of the P (Park) position.

If the ignition switch is placed in the "OFF" or ACC position for any reason while the selector lever is in any positions other than the P (Park) position, the ignition switch cannot be placed in the LOCK position.

If the ignition switch cannot be placed in the LOCK position, perform the following steps:

1. Apply the handbrake.
2. Place the ignition switch in the ON position while depressing the footbrake pedal.
3. Move the selector lever to the P (Park) position.
4. **Models with Intelligent Key system:**



Place the ignition switch in the "OFF" position.

Models without Intelligent Key system:

Place the ignition switch in the LOCK position.

P (Park):

Use this position when the vehicle is parked or when starting the engine. **Make sure that the vehicle is completely stopped and move the selector lever into the P (Park) position.** Apply the handbrake. When parking on a hill, first depress the footbrake pedal, apply the handbrake, and then move the selector lever into the P (Park) position.

R (Reverse):

Use this position to reverse. Make sure that the vehicle is completely stopped before selecting the R (Reverse) position.

When the selector lever is in the R (Reverse) position, either the NISSAN Connect monitor (where fitted) or the ultra sonic parking sensor (where fitted) will be activated. For details, see "Rear-view monitor (where fitted)" or "Around view monitor (where fitted)" earlier in this section or "Ultrasonic Parking Sensor (where fitted)" later in this section

N (Neutral):

Neither the forward nor reverse gear is engaged. The engine can be started in this position. You may shift to the N (Neutral) position and restart a stalled engine while the vehicle is moving.

D (Drive):

Use this position for all normal forward driving.

L (Low):

Use this position when climbing steep hills slowly or driving slowly through deep snow, sand or mud, or for maximum engine braking on steep downhill grades.

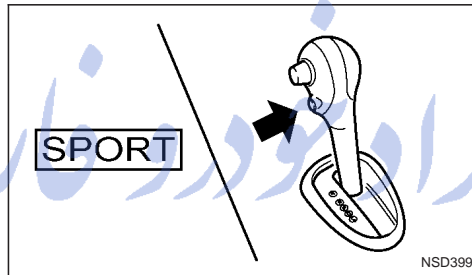

Left-Hand Drive (LHD) model

SPORT mode switch

To select the SPORT mode, push the SPORT mode switch with the selector lever in the D (Drive) position. The SPORT mode indicator light **SPORT** in the meter panel illuminates. To turn off the SPORT mode, push the SPORT mode switch again. The SPORT mode indicator light will turn off. When the selector lever is shifted to any position other than D, the SPORT mode will be automatically turned off.

OFF position:

For normal driving and fuel economy, use the OFF position.

ON position:

For driving up or down long slopes where engine braking is necessary, or for powerful acceleration, use the ON position. The transmission will automatically select a different gear ratio, allowing the engine to provide high output.

When driving conditions change, push the switch to turn the SPORT mode off.

Remember not to drive at high speeds for extended periods of time with the SPORT mode in the ON position. This reduces fuel economy.

Accelerator downshift

- in the D position -

For passing or climbing hills, depress the accelerator pedal to the floor. This shifts the transmission down into a lower gear, depending on the vehicle speed.

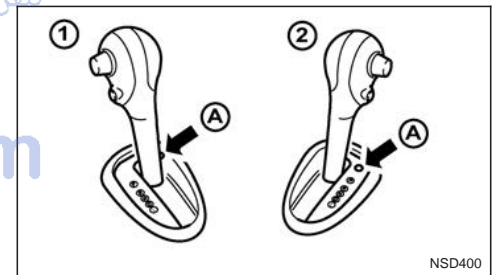

Shift lock release

- ① LHD models
- ② RHD models
- Ⓐ Shift lock release button

If the battery charge is low or discharged, the selector lever may not move from the P (Park) position even with the brake pedal depressed and the selector lever button pushed.

To move the selector lever, perform the following procedure:

1. Models with Intelligent Key system:

Place the ignition switch in the "OFF" or LOCK position.

Models without Intelligent Key system:

Place the ignition switch in the LOCK position, and remove the key if it is inserted.

2. Apply the handbrake.
3. Push down the shift lock release button Ⓐ. Use a suitable tool.
4. Push and hold the selector lever button and move the selector lever to the N (Neutral) position while holding down the shift lock release button.

Place the ignition switch in the ON position to unlock the steering wheel. The vehicle may be moved to the desired location.

For models with Intelligent Key system: If the battery is discharged completely, the steering wheel cannot be unlocked. Do not move the vehicle with the steering wheel locked.

If the selector lever cannot be moved out of the P (Park) position, have a NISSAN dealer or qualified workshop check the CVT system as soon as possible.



WARNING

If the selector lever cannot be moved from the P (Park) position while the engine is running and the brake pedal is depressed, the stop lights may not work. Malfunctioning stop lights could cause an accident injuring yourself and others.

High fluid temperature protection mode

This transmission has a high fluid temperature protection mode. If the fluid temperature becomes too high (for example, when climbing steep grades in high temperature with heavy loads, such as when towing a trailer), engine power and, under some conditions, vehicle speed will be decreased automatically to reduce the chance of transmission damage. Vehicle speed can be controlled with the accelerator pedal, but engine and vehicle speed may be limited.

Fail-safe

When the fail-safe operation occurs, the CVT will not be shifted to the selected driving position.

If the vehicle is driven under extreme conditions, such as excessive wheel spinning and subse-

quent hard braking, the fail-safe system may be activated. This will occur even if all electrical circuits are functioning properly. In this case, place the ignition switch in the "OFF" position and wait for 10 seconds. Then turn the ignition switch back to the ON position. The vehicle should return to its normal operating condition. If it does not return to its normal operating condition, have a NISSAN dealer or qualified workshop check the transmission and repair it if necessary.



WARNING

When the fail-safe operation occurs, vehicle speed may be gradually reduced. The reduced speed may be lower than other traffic, which could increase the chance of a collision. Be especially careful when driving. If necessary, pull to the side of the road at a safe place and allow the transmission to return to normal operation, or have it repaired if necessary.



STOP/START SYSTEM (where fitted)

NISSAN GREEN PROGRAM

The Stop/Start System is designed to prevent unnecessary fuel consumption, exhaust emissions, and noise during a journey:

- When the vehicle comes to rest the engine is automatically stopped*.
- The engine is then automatically restarted before you are ready to drive away**.

CAUTION

At the end of the journey the engine must be stopped and ignition turned OFF. Lock the vehicle as normal. Turning the ignition OFF will shut down all electrical systems. Failure to do this may result in a flat battery.

NORMAL OPERATION

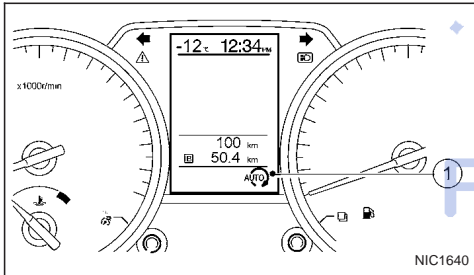

The Stop/Start System has stopped the engine and will automatically restart the engine. The Stop/Start symbol ① is shown in the vehicle information display.

*The Stop/Start System will automatically stop the engine when all the following conditions are valid:

- The gearshift lever is in Neutral position.
- The clutch pedal is fully released.
- The vehicle speed is below about 2 km/h (1 MPH).
- The driver's seat belt is buckled.
- The driver's door is closed.

NOTE

The following conditions must also be satisfied before the engine is automatically stopped. If the engine does not stop this does not indicate a fault with the system:

- The outside air temperature is above about 5°C.
- The engine coolant temperature is at normal operating levels.
- The vehicle has driven some distance since engine start.
- The battery voltage and temperature are within normal levels.
- The vehicle bonnet is closed.
- The steering wheel is not being turned.
- The front and/or rear screen defoggers are turned OFF.

**When the Stop/Start System symbol (1) is displayed the engine starts running automatically under at least one of the following conditions:

- The clutch pedal is depressed.
- The brake pedal is repeatedly pressed (to maintain vehicle braking performance).
- The battery voltage becomes low (due to electrical load from other vehicle systems like headlights, heaters, etc., or auxiliary devices connected to the 12 volt socket inside the vehicle).
- The front and/or rear screen defogger is turned on.
- The vehicle speed is above about 2 km/h (1 MPH).

NOTE

The following conditions will prevent the Stop/Start System automatically restarting the engine. Starting the engine by turning the ignition switch is then necessary:

- The driver's seat belt is unbuckled, or driver's door is open.
- The bonnet is open.

The Stop/Start System is always engaged at the start of a journey (once the engine has been started). The engine is automatically stopped and restarted during the journey if conditions are suitable

When the engine is stopped the following information is displayed for a few seconds.



See "Vehicle information display" in the "2. Instruments and controls" section for information about the display.

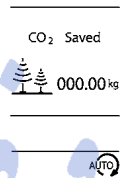

NOTE
Automatic engine restart is possible whenever the Stop/Start System symbol is illuminated at the bottom of the display.

Whilst the engine remains stopped the vehicle information display shows the accumulated quantity (estimate) of carbon dioxide exhaust emissions prevented by the Stop/Start System.



- Push and hold the steering wheel  button to reset the [CO2 Saved] value.
- The display can be switched between Stop/Start System information and drive computer information by a short press of the steering wheel  button



The message can only be cleared by turning the ignition OFF (or restarting the engine).

PRECAUTIONS

The following message is displayed when there may be something wrong with the Stop/Start System. You are advised to have the system checked by a NISSAN dealer or qualified workshop.

The message can be cleared by pressing the steering wheel  button

When automatic restart is not possible the following information is displayed. The engine must be started by turning the ignition switch.



The message can be cleared by pressing the steering wheel  button, restarting the engine, or turning the ignition OFF.



NOTE
The Stop/Start System symbol at the bottom of the display flashes whilst the fault condition remains.

The following information is displayed and a buzzer sounded to remind the driver to turn the ignition OFF to avoid a flat battery



STOP/START SYSTEM OFF SWITCH

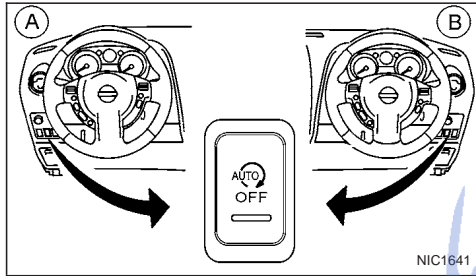

Start System cannot prevent unnecessary fuel consumption, exhaust emissions, or noise during your journey.

NOTE

The following messages may be displayed for a few seconds in the vehicle information display when the Stop/Start System OFF switch is pressed.

Stop/Start System disengaged

Stop/Start System re-engaged



The system can be temporarily disengaged by pressing the Stop/Start System OFF switch. Pressing the button a second time will re-engage the Stop/Start System.

- When the Stop/Start System is disengaged whilst the engine is running, the engine is prevented from automatically stopping.
- When the Stop/Start System is disengaged after the engine has been automatically stopped by the Stop/Start System, the engine will immediately restart if suitable conditions are present as described under NORMAL OPERATION. The engine will then be prevented from automatically stopping during the same journey.
- Whenever the Stop/Start System is disengaged the indicator light on the Stop/Start System OFF switch illuminates. In this condition the Stop/

More information about the Stop/Start System can be checked using the [Settings] menu (see Instruments and Controls)

ENVIRONMENTAL SAVINGS

The vehicle information display keeps a record of the CO₂ savings that can be viewed via the [Settings] menu.

See "Vehicle information display" in the "2. Instruments and controls" section for information about the display.

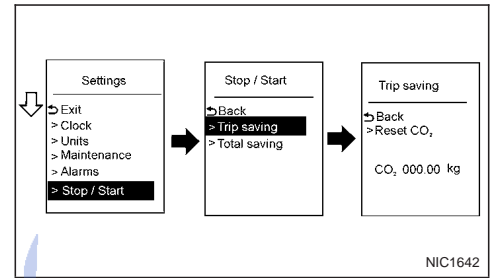

[Trip Saving]

Estimated CO₂ exhaust emissions prevented since last reset.

NOTE

The [Trip Saving] value is the same information that is displayed when the engine is automatically stopped by the Stop/Start System.

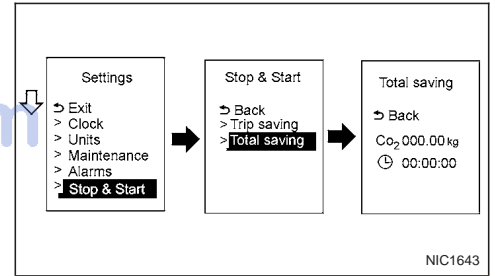

- [Total Saving]

- Estimated CO2 exhaust emissions prevented.
- Time that the engine has been stopped by the Stop/Start System.

NOTE

The [Total Saving] values cannot be reset and show accumulated Stop/Start System information since the vehicle was built.

ULTRASONIC PARKING SENSOR (where fitted)

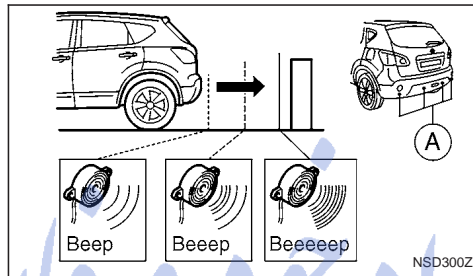

Ultrasonic sensors (A), fitted in the vehicle's rear bumper, measure the distance between the vehicle and an obstacle when reversing. When reverse gear is engaged a beeping sound is heard. The frequency of the beeps will increase the closer you come to the obstacle until, the sound becomes a constant beep when the vehicle is approximately 30 cm (12 in) from the obstacle.

NOTE

- This system is intended as an aid to reversing, to be used in conjunction with your rear view mirror.
- Make sure that the ultrasonic sensors are not obscured (by dirt, mud, snow, etc.).

FOUR-WHEEL DRIVE (4WD) (where fitted)

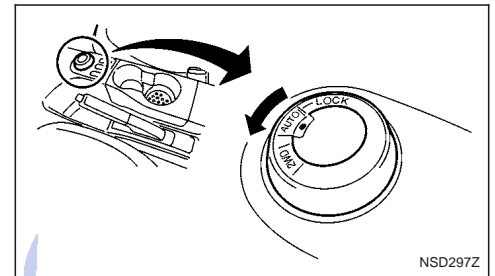

The Four Wheel Drive (4WD) system is used to select 2WD, AUTO, or LOCK depending on the driving conditions.

The Four Wheel Drive (4WD) system controls the coupling operation. Turn the control (located on the centre console) to select each mode: 2WD, AUTO or LOCK depending on the driving conditions.



AUTO: Turn the 4WD mode control to the neutral (AUTO) position and the Four-Wheel Drive (4WD) AUTO indicator light  on the combination meter illuminates.

2WD: Turn the control clockwise to the 2WD position.

LOCK: When the control is turned anticlockwise to the LOCK position, it springs back to the AUTO position when released. The 4WD LOCK mode indicator light  illuminates on the combination meter, to show LOCK mode is engaged. To disengage LOCK mode, turn the control anticlockwise again to the LOCK position and release. The 4WD LOCK mode indicator light will go out.



4WD MODE OPERATIONS

4WD Mode	Wheels driven	4WD mode indicator light 	Driving conditions
2WD	Front wheels- The wheel drive mode is in 2WD when driving on a normal road	Goes off	For driving on dry, paved roads
AUTO	Distribution of torque to the front and rear wheels changes automatically, depending on road conditions encountered [ratio; 100:0 (2WD) → 50:50 (4WD)]. This results in improved driving stability		For driving on paved or slippery roads
LOCK	Four wheels* ¹		For driving on rough roads

*¹ LOCK mode changes to AUTO mode automatically when the vehicle is sharply accelerated or when the vehicle speed is over approximately 40 km/h (25 MPH). The 4WD LOCK indicator light goes off. Turning off the ignition automatically cancels LOCK mode.

CAUTION

Depending on the driving conditions, the 4WD mode may automatically change from 2WD to 4WD even when the 2WD mode is selected.

Do not start the engine while in the 2WD, AUTO, or LOCK mode:

- When on free-roller or jacking the front tyres with the rear tyres on the ground.
- When towing with the rear tyres raised from the ground.

4WD SHIFT TIPS



- If the 4WD mode control is operated while cornering, accelerating or decelerating, or if the ignition is turned OFF while in the AUTO or LOCK position you may feel a jolt - this is normal.
- The oil temperature of power train parts will increase if the vehicle is continuously operated under conditions where the difference in rotation between the front and rear wheels is large (wheel slip), such as when driving the vehicle on rough roads through sand or mud, or when freeing a stuck vehicle. In these cases, the 4WD warning light blinks rapidly, and the 4WD mode changes to the 2WD condition to protect the power train parts. If you stop the vehicle, with the engine idling, and wait until the warning light stops blinking the 4WD mode returns to the AUTO mode.
- Braking distance in 4WD mode is the same as in 2WD mode.

- Even if the mode automatically changes to AUTO mode, when driving in the LOCK mode, the indicator light stays in the LOCK mode.

CAUTION

- Only use the 4WD mode control when driving in a straight direction (to select 2WD, AUTO or LOCK).
- Do not use the 4WD mode control when turning or reversing.
- Do not use the 4WD mode control with the front wheels spinning (to select 2WD, AUTO, or LOCK).
- Be especially careful when starting or driving on slippery surfaces with the 4WD mode set to AUTO.
- Do not drive on dry, hard surfaced roads in the LOCK position.

4WD WARNING LIGHT

Warning light	Indication
 Comes on	There is a malfunction in the Four-Wheel Drive (4WD) system.
 Blinks rapidly	The power train oil temperature is abnormally high.
 Blinks slowly	The difference in wheel rotation is large.

The 4WD warning light is located in the tachometer. The 4WD warning light comes on when the ignition switch is turned to the ON position and turns off soon after the engine is started. If the 4WD warning light comes on, the 4WD mode indicator light will go out.

If the 4WD system malfunctions, or the revolution or radius of the front and the rear wheels differ, the warning light will either remain illuminated or blink as follows:

- High temperature transfer case oil makes the warning light blink rapidly (approximately twice

per second). Stop the vehicle in a safe place with the engine idling. If, after a while, the light goes out you can continue driving.

- Where the difference in rotation between the front and rear wheels is large (wheel slip) - such as when driving on rough roads through sand, mud, or freeing a stuck vehicle - the warning light will blink slowly (approximately once per two seconds). Set the 4WD mode to 2WD and do not drive fast. A large difference in diameters between the front and rear wheels will also cause the 4WD warning light to blink slowly. Check that all the tyre sizes are the same, the tyre pressures are correct, and that the tyres are not worn.

CAUTION

- If the warning light comes on or blinks while driving, 4WD mode will change to 2WD mode. Reduce the vehicle speed and have your vehicle checked by a NISSAN dealer or qualified workshop as soon as possible.
- Do not drive on dry, hard surfaced roads in the LOCK position.
- If the 4WD warning light blinks in the following sequence while driving, proceed as instructed:
 - Blinks rapidly (about twice a second)

Pull off the road at a safe place and idle the engine. The driving mode will change to 2WD to prevent the 4WD system from malfunctioning. The vehicle can be driven again as soon as the warning light turns off.



- Blinks slowly (about once every 2 seconds)

Change the driving mode to 2WD and reduce the vehicle speed as soon as safely possible.

If the warning light is still on after performing the above operation, have the system checked by a NISSAN dealer or qualified workshop as soon as possible.

4WD MODE INDICATOR LIGHTS

-  4WD mode indicator light (LOCK):

This light comes on when the ignition switch is turned to the ON position, and turns off within 1 second. When selecting LOCK mode while the engine is running, this light will illuminate simultaneously along with the 4WD mode indicator light (AUTO).

-  4WD mode indicator light (AUTO):

This light comes on when the ignition switch is turned to the ON position, and turns off within 1 second. If the engine is running, this light will illuminate when selecting AUTO mode.

The 4WD mode indicator light is located in the tachometer.

The light should turn off within 1 second of the ignition switch being turned to the ON position.

While the engine is running, the 4WD mode indicator light will display the position selected by the 4WD mode control.

NOTE

The 4WD mode indicator light may blink while shifting from one drive mode to another. Once shifting is completed, the 4WD mode indicator light will come on. If the indicator light does not come on immediately, make sure that the area around the vehicle is safe and free from obstacles. Drive the vehicle straight (DO NOT accelerate, decelerate or reverse), then turn the 4WD mode control.

If the 4WD warning lights comes on, the 4WD indicator light(s) will go out.

DRIVING FOUR-WHEEL DRIVE (4WD) SAFELY

Your NISSAN is designed for both normal and off-road use. However, avoid driving in deep water or mud as your NISSAN is mainly designed for leisure use, unlike a conventional off-road vehicle.

Remember that Two-Wheel drive (2WD) models are less capable than Four-Wheel Drive (4WD) models for rough road driving and extrication when stuck, for example, in deep snow or mud.

Please observe the following precautions:

- Drive carefully when off-road and avoid dangerous areas. Always wear seat belts to help keep you and your passengers in position when driving over rough terrain.
- Do not drive across steep slopes. Instead drive either straight up or straight down the slope. Off-

road vehicles can tip over sideways much more easily than they can forwards or backwards.

- Many hills are too steep for any vehicle. If you drive up them, you may stall. If you drive down them, you may not be able to control your speed. If you drive across them, you may roll over.
 - Do not shift gears when driving on downhill grades as this could cause loss of control of the vehicle.
 - Stay alert when driving to the top of a hill. At the top there could be a drop-off or other hazard that could cause an accident.
 - If the engine of the vehicle stalls or you cannot make it to the top of a steep grade, never attempt to turn around. Your vehicle could tip or roll over. Always drive backwards and straight down in R (Reverse) gear.
- Never drive backwards under the following conditions as this could result in loss of control:
- with the gear lever in N (Neutral) and/or with the clutch depressed and using the brake (MT models).
 - with the selector lever in N (Neutral) and using only the brake (AT or CVT models).
- Heavy braking down a hill could cause your brakes to overheat and fade, resulting in loss of control and an accident. Apply the brakes lightly and use a low gear to control your vehicle speed.

- Unsecured cargo can be thrown around when driving over rough terrain. Properly secure it so that it will not be thrown forwards and cause injury to you or your passengers.
- To avoid raising the centre of gravity excessively, do not exceed the rated capacity of the roof rack/gear bin (where fitted) and evenly distribute the load. Secure heavy loads in the luggage area as far forwards and as low as possible. Do not equip the vehicle with tyres larger than specified. This could cause your vehicle to rollover.
- Accelerating quickly, sharp steering manoeuvres or sudden braking may cause loss of control.
- Do not drive beyond the performance of the tyres, even with 4WD. Sudden acceleration, steering or braking may result in loss of control and could cause the vehicle to become stuck.
- If at all possible, avoid sharp turning manoeuvres, particularly at high speeds. Your 4WD vehicle has a higher centre of gravity than a 2WD vehicle and can tip over more easily. The vehicle is not designed for cornering at the same speeds as conventional 2WD models any more than low sports cars are designed to perform satisfactorily under off-road conditions. Failure to operate this vehicle correctly could result in loss of control and/or a rollover accident.
- Do not grip the inside or spokes of the steering wheel when driving off-road. The steering wheel could jerk and injure your hands. Instead, drive with your fingers and thumbs on the outside of the rim.
- Before operating the vehicle, ensure that the driver and all passengers have their seat belts fastened.
- Avoid raising the centre of gravity by loading things on the roof or equipping the vehicle with tyres larger than specified in this manual.
- Always drive with the floor mats in place as the floor may become very hot. Particular care should be taken if you are barefoot.
- Lower your speed when encountering strong crosswinds. With its higher centre of gravity your NISSAN is more affected by gusty side winds. Slower speeds ensure better vehicle control.
- Be sure to check the brakes immediately after driving in mud or water as specified in "Wet brakes" later in this section.
- Whenever you drive off-road through sand, mud or water as deep as the wheel hub, more frequent maintenance may be required. For details, refer to the separately provided Warranty Information and Maintenance Booklet.
- Rinse the underside of the vehicle with fresh water after driving through mud or sand. Remove any brush or sticks that are trapped.
- Install the same size of winter tyres on all four (4) wheels (such as studless tyres) or install snow chains to the front wheels when driving on slippery roads (e.g. after a snowfall) and drive carefully using 4WD.
- Avoid parking your vehicle on steep hills. If you get out of the vehicle and it rolls forwards, backwards or sideways, you could be injured.

5-28 Starting and driving



CRUISE CONTROL (where fitted)

The cruise control system allows driving at constant speeds without keeping your foot on the accelerator pedal.

WARNING

- The cruise control system **ONLY** maintains a constant vehicle speed, it does not replace the driver.
- Always observe the posted speed limits and do not set the speed above them.
- Do not use the cruise control system when driving under the following conditions. Doing so could cause a loss of vehicle control and result in an accident.
 - When it is not possible to keep the vehicle at a constant speed
 - When driving in heavy traffic
 - When driving in traffic that varies speed
 - When driving in windy areas
 - When driving on winding or hilly roads
 - When driving on slippery (rain, snow, ice, etc.) roads

CAUTION

On manual transmission models, do not shift into N (Neutral) without depressing the clutch pedal when the cruise control is set. Should this occur, depress the clutch pedal and turn the cruise control main switch off immediately. Failure to do so may cause engine damage.

When the cruise control system is on the speed limiter cannot be operated.

The cruise control system operation switches are located on the steering wheel (right side).

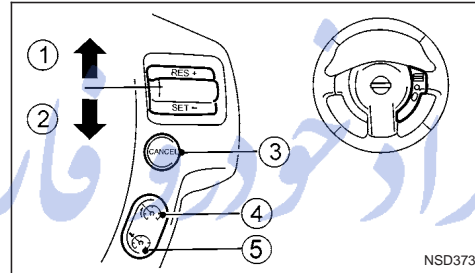

1. RES (Resume) switch
2. SET switch
3. CANCEL switch
4. Speed limiter main "ON/OFF" switch (For details, see "Speed limiter" later in this section)
5. Cruise control main "ON/OFF" switch

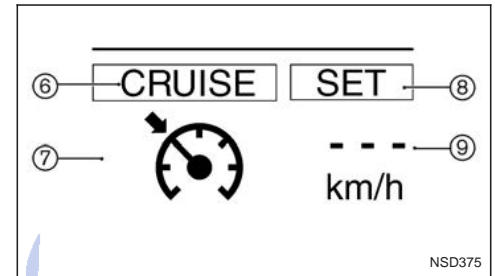

6. CRUISE indicator
7. Cruise control symbol
8. SET indicator
9. Set speed value

The cruise control system operating condition is shown in the vehicle information display. For details, see "Cruise control/Speed limiter indicator (where fitted)" in the "2. Instruments and controls" section.

PRECAUTIONS ON CRUISE CONTROL

- The cruise control system will be automatically cancelled when there is a malfunction. Have the system checked by a NISSAN dealer or qualified workshop.
- To properly set the cruise control system, perform the steps as described in "Cruise control system operations" later in this section.

CRUISE CONTROL SYSTEM OPERATIONS

The cruise control system can be set at the following speeds:

Engine type	Minimum speed	Maximum speed
1.6 petrol HR16DE	45 km/h (30 MPH)	MT: 170 km/h (100 MPH) CVT: 155 km/h (95 MPH)
2.0 petrol MR20DE		MT: 185 km/h (110 MPH) CVT: 175 km/h (105 MPH)
1.5 diesel K9K	30 km/h (20 MPH)	166 km/h (70 MPH)
2.0 diesel M9R	30 km/h (18 MPH)	170 km/h (106 MPH)
1.6 diesel R9M	40 km/h (25 MPH)	190 km/h (119 MPH)

Turning the cruise control system on

The cruise control system can be switched on after engine start or when driving.

Push the cruise control main switch (5). The CRUISE indicator and the cruise control symbol (7) will illuminate in the combination meter display.

Setting a cruising speed

1. Accelerate to the desired cruising speed.
2. Push the SET switch (2) downwards and release it.
3. The SET indicator (8) and the set speed value (9) will be displayed in the combination meter display.

4. Take your foot off the accelerator pedal.

The vehicle will maintain the set speed.

If the vehicle speed is less than the minimum set speed (see table), it will not be possible to set the cruise control system.

Changing a cruising speed

Use any one of the following methods to change the cruising speed.

- Slow the vehicle as normal using the footbrake pedal, the SET indicator (8) in the combination meter will be turned off.

When the vehicle reaches the desired cruising speed, push and release the SET switch (2) downwards.

The new set speed value (9) and SET indicator (8) will be displayed in the combination meter.

- Press the accelerator pedal.

When the vehicle reaches the desired cruising speed, push and release the SET switch (2) downwards.

The new set speed value (9) and SET indicator (8) will be displayed in the combination meter.

- Push and release the RES (resume) (1) switch upwards or the SET switch (2) downwards to increase or decrease the set speed in steps of:

1 km/h or 1 MPH for **petrol models or R9M diesel models**

2 km/h or 2–3 MPH **K9K diesel models**

2 km/h or 1 MPH for **M9R diesel models**

- Push and hold the RES (resume) (1) switch upwards or the SET switch (2) downwards. The vehicle speed will increase or decrease to the new set speed.

The new set speed value (9) will be displayed in the combination meter.

Passing another vehicle

Depress the accelerator pedal to accelerate. After releasing the accelerator pedal, the vehicle will return to the previously set speed.

The set speed value (9) will flash until the vehicle returns to the previously set speed.

Cancelling the cruise control system

To cancel a set speed limit, push the CANCEL switch (3). The SET indicator (8) in the combination meter will be turned off.

The set speed value (9) will remain displayed, as this speed is now stored in the cruise control system memory.

The cruise control system will also be cancelled automatically by any of the following:

- Pressing the footbrake pedal.
- Pressing the clutch pedal.
- Moving the gear lever (MT models) or selector lever (AT or CVT models) to the N (Neutral) position.

5-30 Starting and driving

SPEED LIMITER

- If the vehicle slows down more than approximately 12 km/h (8 MPH) below the set speed.

Resuming a previous cruising speed

If the cruising speed has been cancelled, the set speed value ⑨ will remain displayed in the combination meter and the speed will be stored in the cruise control system memory. This cruising speed can be reactivated by pressing the RES (Resume) switch ① upwards.

If the vehicle speed is less than the minimum set speed (see table), it will not be possible to resume to the cruising speed.

Turn the cruise control system off

The cruise control system will be turned off when one of the following operations is performed:

- Push the cruise control main "ON/OFF" switch ⑤. The cruise control symbol ⑦, the CRUISE indicator ⑥, the SET indicator ⑧, and the set speed value ⑨ will turn off in the combination meter display
- Push the speed limiter main "ON/OFF" switch ⑤. The cruise control system information in the combination meter will be replaced with the speed limiter information. For details see "Speed limiter" later in this section.
- When the vehicle is stopped and the ignition is turned to the off position.

Turning off the cruise control system will erase the cruise control system memory.

The speed limiter allows you to set the desired vehicle speed limit. While the speed limiter is activated, you can perform normal braking and acceleration, but the vehicle will not exceed the set speed.

When the vehicle reaches the set speed limit or if the set speed limit is lower than the actual vehicle speed, the accelerator pedal will not work until the vehicle speed drops below the set speed limit.



WARNING

- **The speed limiter will not automatically brake the vehicle to the set speed limit.**
- **Always observe posted speed limits. Do not set the speed above them.**
- **Always confirm the setting status of the speed limiter in the combination meter display.**
- **When the speed limiter is set, avoid hard acceleration to reach the set limit to ensure that the system can limit the speed of the vehicle correctly.**
- **When additional floor mats are used, be sure that they are correctly secured and that they cannot interfere with the accelerator pedal. Mats not adapted to the vehicle may prevent proper operation of the speed limiter.**

When the speed limiter is on the cruise control system cannot be operated.

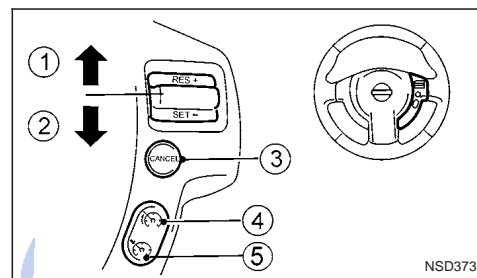

NSD373

1. RES + (Resume) switch
2. SET - (Set) switch
3. CANCEL switch
4. Speed limiter main "ON/OFF" switch
5. Cruise control main "ON/OFF" switch (For details, see "Cruise control (where fitted)" earlier in this section)

The speed limiter operation switches are located on the steering wheel (right hand side)

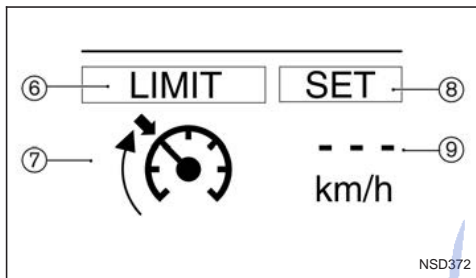

The speed limiter operating condition is shown in the vehicle information display. For details, see "Vehicle information display" in the "2. Instruments and controls" section.

6. LIMIT indicator
7. Speed limiter symbol
8. SET indicator
9. Set speed value

SPEED LIMITER OPERATIONS

The speed limiter can be set at the following speeds:

Engine type	Minimum speed	Maximum speed
1.6 petrol HR16DE	30 km/h (20 MPH)	170 km/h (105 MPH)
2.0 petrol MR20DE		MT: 190 km/h (118 MPH) CVT: 170 km/h (105 MPH)
1.5 diesel K9K	30 km/h (20 MPH)	184 km/h (114 MPH)
2.0 diesel M9R		200 km/h (125 MPH)
1.6 diesel R9M		190 km/h (118 MPH)

Turning the speed limiter on

The speed limiter can be switched on after engine start or when driving.

Push the speed limiter main "ON/OFF" switch (4). The speed limiter symbol (7) and the LIMIT indicator (6) will illuminate in the combination meter display.

Setting speed limit

Push the SET switch (2) (downwards)

For 1.6 petrol (HR16DE), 2.0 petrol (MR20DE), 2.0 diesel (M9R) or 1.6 diesel (R9M) models:

- The speed limit will be set at the current speed.
- When driving less than 30 km/h (20 MPH), the speed limiter will be set to the minimum possible set speed of 30 km/h (20 MPH).

For 1.5 diesel (K9K) models only:

When driving less than 30 km/h (20 MPH), it will not be possible to set the speed limit.

When the speed limit is set, the SET indicator (8) and the set speed value (9) will be displayed in the combination meter display.

Changing a speed limit

Use either of the following operations to change an active speed limit:

For 1.6 petrol (HR16DE), 2.0 petrol (MR20DE), 2.0 diesel (M9R) or 1.6 diesel (R9M) models:

- Push and release the RES (Resume) switch (1) upwards or SET switch (2) downwards. Each time you do this, the set speed will increase or decrease by 1 km/h (1 MPH).
- Push and hold the RES (Resume) switch (1) upwards or SET switch (2) downwards. The set speed will increase or decrease to the next multiple of 10 km/h (10 MPH) and then in steps of 10 km/h (10 MPH).

For 1.5 diesel (K9K) models only:

- Push and release the RES (Resume) switch (1) upwards or SET switch (2) downwards. Each time you do this, the set speed will increase or decrease by 2 km/h (2 MPH).
- Push and hold the RES (Resume) switch (1) upwards or SET switch (2) downwards. The set speed will increase or decrease in steps of 4 km/h (2-3 MPH).

The new set speed limit value ⑨ will be displayed in the combination meter display.

Cancelling a speed limit

To cancel a set speed limit, push the CANCEL switch ③. The SET indicator ⑧ in the combination meter will be turned off. The set speed value ⑨ will remain displayed.

It is also possible to override the speed limiter by fully depressing the accelerator pedal beyond the resistance point.

WARNING

- The vehicle may accelerate when the speed limiter cancels.
- When additional floor mats are used, be sure that they are correctly secured and that they cannot interfere with the accelerator pedal. Mats not adapted to the vehicle may prevent proper operation of the speed limiter.

Fully depress the accelerator pedal beyond the resistance point. The speed limiter will be suspended to allow driving above the set speed. The set speed value ⑨ will flash. The speed limiter will automatically resume when the vehicle speed drops below the set speed limit.

Resuming a previous set speed

If a set speed limit has been cancelled, the set speed value ⑨ will remain displayed in the combination meter and the speed will be stored in the speed limiter memory.

This speed limit can be reactivated by pressing the RES (Resume) switch ① upwards.

If the current vehicle speed is higher than the previous set speed, the accelerator pedal will not work and the set speed value ⑨ will flash until the vehicle speed drops below the set speed limit.

Turning the speed limiter off

The speed limiter system will be turned off when one of the following operations is performed:

- Push the speed limiter main "ON/OFF" switch ④. The speed limiter symbol ⑦, the LIMIT indicator ⑥, the SET indicator ⑧, and the set speed value ⑨ will turn off in the combination meter display.
- Push the cruise control main "ON/OFF" switch ⑤. The speed limiter information in the combination meter will be replaced with the cruise control information. For details see "Cruise control (where fitted)" earlier in this section.
- When the vehicle is stopped and the ignition is turned to the off position.

Turning off the speed limiter will erase the set speed limit memory.

Speed limiter malfunction

If the speed limiter malfunctions, the set indicator ⑧ in the combination meter display will flash.

Turn the speed limiter off by pushing the speed limiter main "ON/OFF" switch ④ and have the system checked by a NISSAN dealer or qualified workshop.

PARKING

WARNING

- Do not park the vehicle over flammable materials, such as dry grass, waste paper, or rags. They may ignite and cause a fire.
- Safe parking procedures require that:
 - The handbrake is applied.
 - The gear lever is placed in an appropriate gear for manual transmission models.
 - The selector lever is placed in the P (Park) position for automatic transmission or continuously variable transmission models.Failure to follow the above recommendations could cause the vehicle to move unexpectedly or roll away and result in an accident.
- Never leave the engine running while the vehicle is unattended.
- Do not leave children or adults who would normally require the support of others alone in your vehicle. Pets should also not be left alone either. On hot, sunny days, temperatures in a closed vehicle could quickly become high enough to cause severe or possibly fatal injuries to people or animals.
- Manual transmission models:

Depress the clutch pedal and place the gear lever in the R (Reverse) position. When parking on an uphill gradient, place the gear lever in the 1st (Low gear) position.

- **Automatic transmission or Continuously variable transmission models:**

Fully depress the brake pedal and move the selector lever to the P (Park) position.

! WARNING

Make sure that the selector lever has been pushed as far forward as it can go and cannot be moved without depressing the button on the selector lever handle.

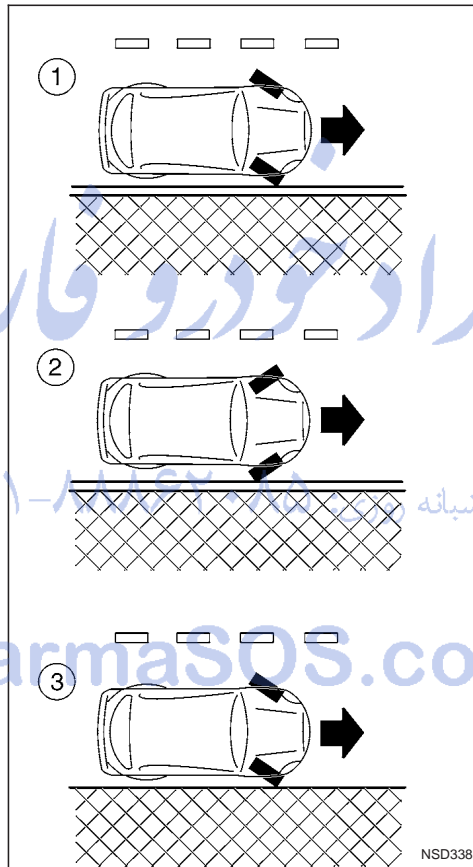

LHD models

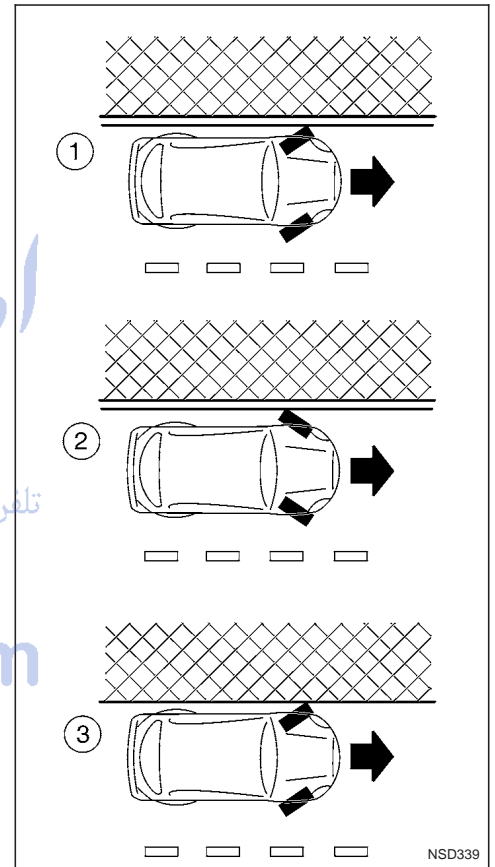

RHD models



TRAILER TOWING

- When parked on a sloping driveway, turn the wheels so the vehicle will not roll into the street in case it moves.

- **FACING DOWNHILL:** ①

Turn the wheels into the kerb, allow the vehicle to move forward until the kerb side wheel gently touches the kerb. Then set the handbrake.

- **FACING UPHILL:** ②

Turn the wheels away from the kerb and allow the vehicle to move back until the kerb side wheel gently touches the kerb. Then set the handbrake.

- **NO KERB — FACING DOWNHILL OR UPHILL:** ③

Turn the wheels toward the side of the road so the vehicle will move away from the centre of the road if it moves. Then set the handbrake.

- Turn the ignition switch to the LOCK position and remove the key/Intelligent Key (where fitted).

- Always turn off ignition after parking a vehicle with Stop/Start System fitted to avoid a possible flat battery.

NOTE

The Stop/Start System is designed to prevent unnecessary fuel consumption, exhaust emissions and noise during a journey. The Stop/Start System does not automatically turn off ignition at the end of a journey.

Your new vehicle was designed to be used primarily to carry passengers and luggage.

Remember that towing a trailer will place additional loads on your vehicle's engine, drive-train, steering, braking and other systems. Towing a trailer will also exaggerate other conditions, such as sway caused by crosswinds, rough road surfaces or passing trucks. Driving style and speed must be adjusted according to the circumstances. Before towing a trailer, see a NISSAN dealer or qualified workshop for an explanation of towing equipment and its proper use.

OPERATING PRECAUTIONS

- Avoid towing a trailer during the running-in schedule.
- Choose proper coupling devices (trailer hitch, safety chain, roof carrier, etc.) for your vehicle and trailer. These devices are available from a NISSAN dealer or qualified workshop where you can also obtain more detailed information about trailer towing.

Heavy-duty kits are available at a NISSAN dealer or qualified workshop.

- It is advisable to contact a NISSAN dealer or qualified workshop for towing details, before towing a trailer up steep slopes for long distances.
- Never allow the total trailer load (trailer weight plus its cargo weight) to exceed the maximum set for the coupling device.

Contact a NISSAN dealer or qualified workshop for more information on this matter.

- The trailer must be loaded so that heavy goods are distributed over the axle and as low in the trailer as possible. Poor load distribution can seriously affect the stability of the trailer and tow vehicle.
- Do not exceed the maximum permitted vertical load on the trailer hitch.
- Before driving, make sure that the lighting system of the trailer works properly.
- When towing with 4WD models, the 4WD mode switch should be in the AUTO position. Using the vehicle in AUTO mode gives better traction, particularly when moving off from stationary and/or on an incline, as the vehicle is less likely to wheel spin.
- Avoid abrupt starts, accelerations and stops.
- Avoid sharp turns and lane changes.
- Always drive your vehicle at a moderate speed.
- Always block the wheels on both vehicle and trailer when parking. Apply the handbrake (where fitted) on the trailer. Parking on a steep slope is not recommended.

If parking on a steep slope is unavoidable it is also advisable to put the vehicle into gear, or select P (Park (AT or CVT models), and turn the front wheels into the kerb (in addition to the other precautions described). Before parking on a

steep slope consider the incline (the towing weights quoted are for a 12% slope).

- Follow the trailer manufacturer's instructions.
- Have your vehicle serviced more often than at the intervals specified in the separately provided Warranty Information and Maintenance booklet.
- Trailer towing requires more fuel than under normal circumstances because of a considerable increase in traction power required and resistance.
- When towing a trailer, observe the following restricted towing speed:
Speed: below 100 km/h (62 MPH)

CAUTION

While towing a trailer, check the engine coolant temperature gauge regularly to prevent engine overheating.

TYRE PRESSURE

When towing a trailer, inflate the vehicle tyres to the maximum recommended COLD tyre pressure, as indicated on the tyre placard (for full loading). Make sure the trailer tyre pressures are correct.

CAUTION

Do not tow a trailer when the vehicle is installed with a temporary-use spare tyre.

SAFETY CHAINS

Always use a suitable chain between the vehicle and trailer. The chain should be attached to the hitch and not to the vehicle bumper or axle. Be sure to leave enough slack in the chain to permit turning corners. The chain should not drag on the ground: passing the chain across the trailer hitch may be the best practice depending on your trailer.

TRAILER BRAKES

Ensure that trailer brakes are installed as required by local regulations. Also check that all other trailer equipment conforms to local regulations.

TRAILER DETECTION (where fitted)

When towing a trailer and the turn signal switch is used, the electrical system of the vehicle will detect an additional electrical load of the trailer lighting. As a result, the trailer direction indicator light comes on.

INSTALLATION OF COUPLING DEVICE

NISSAN recommends that the coupling device for trailer towing be installed under the following conditions:

- Maximum permissible vertical load on the coupling device: 736 N (75 kg, 165 lb)
- The coupling device, mounting points and installation parts on your vehicle: as shown as an example in the illustration.

Follow all of the coupling device manufacturer's instructions for installation and use.



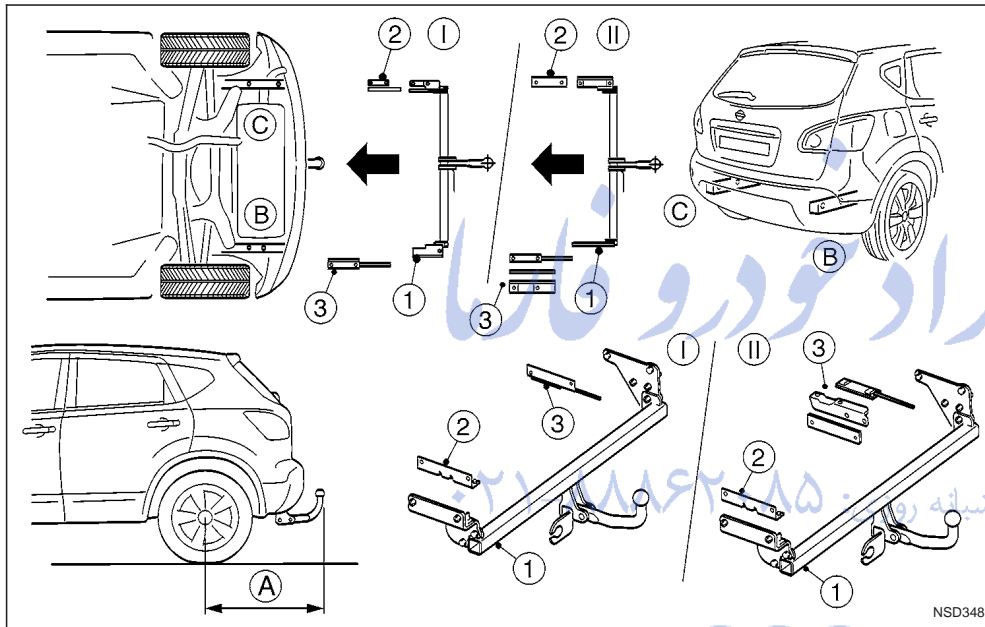

NSD348

FarmaSOS.com

- Ⓘ 5-seater
- Ⓜ 7-seater

Rear overhang of coupling device:

Ⓐ	5-seater	925 mm (36.4 in)
	7-seater	977 mm (38.5 in)

VEHICLE SECURITY

When leaving your vehicle unoccupied:

- Always remove the ignition key or Intelligent Key (where fitted) and take it with you – even in your own garage.
- Close all windows completely and lock all doors.
- Always park your vehicle where it can be seen. At night, park in a well lit area.
- If the vehicle is equipped with an alarm or immobilization device, use it – even for short periods.
- Do not leave children and pets in the vehicle unattended.
- Do not leave valuables on view to tempt a thief. Always take your valuables with you. If you must leave something in your vehicle, lock it in the luggage compartment or hide it out of sight.
- Do not leave the vehicle documents in your vehicle. In the unfortunate event of your vehicle being stolen, the documents will only help a thief to sell the vehicle.
- Do not leave articles on a roof rack as they are particularly vulnerable. If possible, remove them from the rack and lock them inside the vehicle.
- Do not leave the spare key or Intelligent Key in the vehicle – keep it in a safe place at home.
- Do not leave a note of your vehicle's key number in the vehicle. A thief may break into the vehicle, note the key number and return with a new key and drive the vehicle.

POWER STEERING SYSTEM



WARNING

- **If the Electrically Power Assisted Steering warning light (EPAS) illuminates while driving, the power assist for steering will be disabled. Greater steering efforts are required to operate the steering wheel, especially in sharp turns and at low speed. Stop the vehicle as soon as safely possible and contact a NISSAN dealer or qualified workshop for further assistance.**
- **In certain circumstances, factors external to the EPAS system may contribute to the illumination of the warning light. If the warning light illuminates, stop the vehicle as soon as safely possible if driving. Turn the ignition switch to the "OFF" position and wait for approximately 20 seconds, then turn the ignition switch to the ON position again. If the light remains illuminated, we recommend you to contact a NISSAN dealer or qualified workshop. See "Warning/indicator lights and audible reminders" in the "2. Instruments and controls" section for further details regarding the EPAS warning light.**

The EPAS (Electrically Power Assisted Steering) system is designed to assist steering.

The steering may appear to feel slightly stiff following parking manoeuvres including a great deal of steering. This is not a malfunction; it is caused by a control system designed to prevent the motor from

overheating. No servicing is required. The EPAS system will return to normal operation the next time the vehicle is driven.

Similarly, the EPAS system may not provide full assistance during periods of reduced battery voltage but will recover once normal battery voltage is restored.

If the EPAS warning light comes on while the engine is running, it may indicate that the EPAS system is not working properly. As result greater steering efforts are required to steer the steering wheel, especially in sharp turns and at low speeds. Have the system checked by a NISSAN dealer or qualified workshop as soon as possible.

NOTE

Incorrectly inflated tyres can lead to poor steering ability and make the driver suspect a steering problem: keep the vehicle's tyres inflated to the correct pressure at all times.

CAUTION

Any malfunction or accident that could have damaged the steering components (including actual or attempted theft damage) should be reported to a NISSAN dealer or qualified workshop.



BRAKE SYSTEM

The brake system has two separate hydraulic circuits. If one circuit malfunctions, you will still have braking ability with two wheels.

BRAKE PRECAUTIONS

Vacuum assisted brake

The brake booster aids braking by using engine vacuum. If the engine stops or the drive belt is broken, you can stop the vehicle by depressing the brake pedal. However, greater foot pressure on the brake pedal will be required to stop the vehicle and the stopping distance will be longer.

Wet brakes

When the vehicle is washed or driven through water, the brakes may get wet. As a result, your braking distance will be longer and the vehicle may pull to one side during braking.

To dry brakes, drive the vehicle at a safe speed while lightly pressing the brake pedal to heat up the brakes. Do this until the brakes return to normal. Avoid driving the vehicle at high speeds until the brakes function correctly.

Using the brakes

Avoid resting your foot on the brake pedal while driving. This will overheat the brakes, wear out the brake linings and pads faster and reduce fuel economy performance.

To help reduce brake wear and to prevent the brakes from overheating, reduce speed and downshift to a lower gear before going down a slope or long down-

hill gradient. Overheated brakes may reduce braking performance and could result in loss of vehicle control.

CAUTION

While driving on a slippery surface, be careful when braking, accelerating or downshifting. Abrupt braking actions or sudden acceleration could cause the wheels to skid and result in an accident.

Be aware that brakes will fade if repeated heavy brake applications are made.

Driving uphill

When starting on a steep gradient, it is sometimes difficult to operate the brake (AT or CVT models) or both the brake and clutch (MT models). Use the handbrake to hold the vehicle. Do not slip the clutch (MT models). When ready to start, slowly release the handbrake while depressing the accelerator pedal and releasing the clutch (MT models) or depressing the accelerator pedal (AT or CVT models).

Driving downhill

The engine braking action is effective for controlling the vehicle while descending hills.

The gear lever (MT models) should be placed in a gear position low enough to obtain sufficient engine braking.

For the AT or CVT models, a low gear position in the manual shift mode, low enough to obtain sufficient engine braking, should be selected.

ANTI-LOCK BRAKING SYSTEM (ABS)

WARNING

- The Anti-lock Braking System (ABS) is a sophisticated device, but it cannot prevent accidents resulting from careless or dangerous driving techniques. It can help maintain vehicle control during braking on slippery surfaces. Remember that stopping distances may also be longer on rough, gravel or snow covered roads, or if you are using snow chains. Always maintain a safe distance from the vehicle in front of you. Ultimately, the driver is responsible for safety.
- Tyre type and condition may also affect braking effectiveness.
 - When replacing tyres, install the specified size of tyres on all four wheels.
 - When installing a spare tyre, make sure it is the proper size and type as specified on the tyre placard. See "Vehicle identification" in the "9. Technical information" section for the tyre placard location.
 - For detailed information, see "Wheels and tyres" in the "8. Maintenance and do-it-yourself" section.

The Anti-lock Braking System (ABS) controls the brakes so that the wheels do not lock during hard braking or when braking on slippery surfaces. The system detects the rotation speed at each wheel

and varies the brake fluid pressure to prevent each wheel from locking and sliding. By preventing each wheel from locking, the system helps the driver to maintain steering control and helps to minimise swerving and spinning on slippery surfaces.

Using the system

Depress the brake pedal and hold it down. Depress the brake pedal with firm steady pressure, but do not pump the brakes. The ABS will operate to prevent the wheels from locking up. Steer the vehicle to avoid obstacles.



WARNING

Do not pump the brake pedal. Doing so may increase the stopping distance.

Self-test feature

The ABS includes electronic sensors, electric pumps, hydraulic solenoids and a computer. The computer has a built-in diagnostic feature that tests the system each time you start the engine and move the vehicle at a low speed in forward or reverse. When the self-test occurs, you may hear a "clunk" noise and/or feel a pulsation in the brake pedal. This is normal and does not indicate a malfunction. If the computer senses a malfunction, it switches the ABS off and illuminates the ABS warning light on the instrument panel. The brake system then operates normally, but without anti-lock assistance.

If the ABS warning light illuminates during the self-test or while driving, have the vehicle checked by a NISSAN dealer or qualified workshop.



Normal operation



The ABS will not initiate at speeds below 5 to 10 km/h (3 to 6 MPH). The speeds will vary according to road conditions.

When the ABS senses that one or more wheels are close to locking up, the actuator rapidly applies and releases hydraulic pressure. This action is similar to pumping the brakes very quickly. You may feel a pulsation in the brake pedal and hear a noise from the actuator under the bonnet when it is operating. This is normal and indicates that the ABS is working properly. However, the pulsation may indicate that road conditions are hazardous and extra care is required while driving.

ELECTRONIC STABILITY PROGRAMME (ESP) SYSTEM (where fitted)

When accelerating, driving on slippery surfaces or suddenly avoiding obstacles on roads, the vehicle might swerve or slip. The Electronic Stability Programme (ESP) system continuously monitors and compares the driver's intended speed and the travel direction. The system adjusts wheel brake pressure and engine torque to assist in improving vehicle stability.

- When the ESP system is operating, the "SLIP" indicator light () in the combination meter blinks.
- When only the traction control (TCS) system in the ESP system is operating, the "SLIP" indicator light () in the combination meter will also blink.
- If the "SLIP" indicator light () blinks, the road conditions are slippery. Be sure to drive carefully. See "Warning/indicator lights and audible reminders" in the "2. Instruments and controls" section.
- Indicator light

If a malfunction occurs in the system, the "SLIP" indicator light () and the ESP indicator light () come on in the combination meter.

As long as these indicator lights are on, the traction control function is cancelled.

The ESP system uses Active Brake Limited Slip (ABLS) system to improve vehicle traction. The Active Brake Limited Slip (ABLS) system works when one of the driving wheels is spinning on a slippery



surface. The Active Brake Limited Slip (ABLS) system, brakes the spinning wheel to distribute the driving power to the other driving wheel.









If the vehicle is operated with the ESP system turned off, all ESP and TCS functions will be turned off. The Active Brake Limited Slip (ABLS) system and ABS will still operate with the ESP system off. If the Active Brake Limited Slip (ABLS) system or the ABS is activated, the "SLIP" indicator light () will blink and you may hear a clunk noise and/or feel a pulsation in the brake pedal. This is normal and does not indicate a malfunction.

While the ESP system is operating, you may feel a pulsation in the brake pedal and hear a noise or vibration from under the bonnet. This is normal and indicates that the ESP system is working properly.

The ESP computer has a built in diagnostic feature that tests the system each time the engine is started and the vehicle moves forwards or reverses at a slow speed. When the self-test occurs, you may hear a clunk noise and/or feel a pulsation in the brake pedal. This is normal and is not an indication of a malfunction.

 **WARNING**

- The ESP system is designed to help improve driving stability but does not prevent accidents caused by abrupt steering operation at high speeds, or careless or dangerous driving techniques. Reduce vehicle speed and be especially careful when driving and cornering on slippery surfaces. Always drive carefully.

- If engine related parts, such as a muffler, are not standard equipment or are extremely deteriorated, the ESP OFF indicator light () and/or the "SLIP" indicator light () may illuminate.
- If brake related parts, such as brake pads, rotors and callipers, are not standard equipment or are extremely deteriorated, the ESP system may not operate properly and the ESP OFF indicator light () and/or the "SLIP" indicator light () may illuminate.
- Do not modify the vehicle's suspension. If suspension parts, such as shock absorbers, struts, springs, stabiliser bars and bushings, are not NISSAN-approved or are extremely deteriorated, the ESP system may not operate properly. This could adversely affect vehicle handling performance and the ESP OFF indicator light () and/or the "SLIP" indicator light () may illuminate.
- When driving on extremely inclined surfaces, such as higher banked corners, the ESP system may not operate properly and the ESP OFF indicator light () and/or the "SLIP" indicator light () may illuminate. Do not drive on these types of roads. If ESP OFF indicator light  does illuminate after driving on extreme surfaces, restart the engine to reset the ESP system.
- If wheels or tyres other than the recommended ones are used, the ESP system may not operate properly and the ESP

OFF indicator light () and/or the "SLIP" indicator light () may illuminate.

- The ESP system is not a substitute for winter tyres or snow chains on a snow covered road.

NOTE

- The ESP system should be switched on under normal circumstances although it may be advantageous to switch off the ESP system to allow wheelspin under the following conditions:
 - When driving in deep snow or mud.
 - When trying to rock a vehicle free that is stuck in snow.
 - When driving with snow chains.
- If the ESP system has been switched off, drive carefully with reduced speed. When road conditions allow, ESP should be switched back on.

ELECTRONIC STABILITY PROGRAMME (ESP) OFF SWITCH

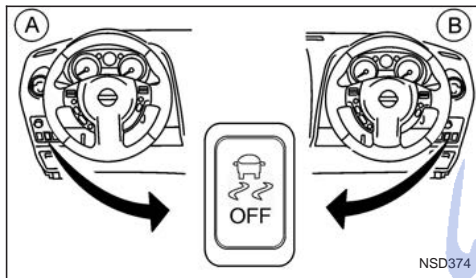

(A) LHD models

(B) RHD models

The vehicle should be driven with the Electronic Stability Programme (ESP) system "ON" for most driving conditions.

When the vehicle get stuck in mud or snow, the ESP system reduces the engine output to decrease wheel spin. The engine speed will be reduced even if the accelerator is depressed to the floor. If maximum engine power is needed to free a stuck vehicle, turn the ESP system off.

To turn off the ESP system, push the ESP OFF switch. The ESP OFF indicator light () will come on.

NOTE

The ESP system cannot be switched off when the ESP system is operating and the "SLIP" indicator light () is blinking.

Push the ESP OFF switch again, or restart the engine, to turn the system ON. See "Electronic Stability Programme (ESP) system (where fitted)" earlier in this section for operational details.

COLD WEATHER DRIVING

WARNING

- Whatever the conditions, drive with caution. Accelerate and decelerate with great care. If accelerating or decelerating too fast, the drive wheels will lose even more traction.
- Allow more stopping distance in cold weather driving. Braking should be started sooner than on dry surfaces.
- Keep at a greater distance from the vehicle in front of you on slippery roads.
- Wet ice (0°C, 32°F and freezing rain), very cold snow and ice can be slick and very difficult to drive on. The vehicle will have a lot less traction or grip under these conditions. Try to avoid driving on wet ice until the road is salted or sanded.
- Watch for slippery spots (black ice). These may appear on an otherwise clear road in shaded areas. If a patch of ice is seen ahead, brake before driving on it. Try not to brake while actually on the ice and avoid any sudden steering manoeuvres.
- Do not use cruise control (where fitted) on slippery roads.
- Snow can trap dangerous exhaust gas under your vehicle. Keep snow clear of the exhaust pipe and from around your vehicle.



BATTERY

If the battery is not fully charged during extremely cold weather conditions, the battery fluid may freeze and damage the battery. To maintain maximum efficiency, the battery should be checked regularly. For details, see "Battery" in the "8. Maintenance and do-it-yourself" section.

ENGINE COOLANT

If the vehicle is to be left outside without anti-freeze, drain the cooling system. Refill before operating the vehicle. For details, see "Engine cooling system" in the "8. Maintenance and do-it-yourself" section.

TYRE EQUIPMENT

- 1) The SUMMER tyres are of a tread design to provide superior performance on dry surfaces. However, the performance of these tyres will be substantially reduced in snowy and icy conditions. If you operate your vehicle on snowy or icy roads, NISSAN recommends the use of MUD & SNOW or ALL SEASON tyres on all four wheels. Please consult a NISSAN dealer or qualified workshop for tyre type, size, speed rating and availability information.
- 2) For additional traction on icy roads, studded tyres may be used. However, some countries, provinces and states prohibit their use. Check applicable laws before installing studded tyres.

CAUTION

Skid and traction capabilities of studded snow tyres on wet or dry surfaces may be poorer than that of non-studded snow tyres.

- 3) Snow chains may be used, if desired. But the use of snow chains may be prohibited in some areas. Therefore, check the local laws before installing snow chains. When installing snow chains, make sure they are of proper size for the tyres on your vehicle and are installed according to the snow chain manufacturer's instructions. Use chain tensioners when recommended by the snow chain manufacturer to ensure a tight fit. Loose end links of the snow chain must be secured or removed to prevent the possibility of whipping action damage to the wings or undercarriage. In addition, drive at a reduced speed, otherwise, your vehicle may be damaged and/or vehicle handling and performance may be adversely affected.

SPECIAL WINTER EQUIPMENT

It is recommended to carry the following items in the vehicle during winter:

- A scraper and stiff-bristled brush to remove ice and snow from the windows.
- A sturdy, flat board to be placed under the jack to give it firm support.
- A shovel to dig the vehicle out of snowdrifts.
- Extra windscreen washer fluid to refill the reservoir tank.

CORROSION PROTECTION

Chemicals used for road surface de-icing are extremely corrosive and will accelerate corrosion and the deterioration of underbody components such as the exhaust system, fuel and brake lines, brake cables, floor pan, and wings.

In the winter, the underbody must be cleaned periodically. For additional information, see "Corrosion protection" in the "7. Appearance and care" section.

For additional protection against rust and corrosion, which may be required in some areas, consult a NISSAN dealer or qualified workshop.

NOTE

امداد خودرو فارما

تلفن شبانه روزی: ۰۲۱-۸۸۸۶۲۰۸۵

FarmaSOS.com

5-44 Starting and driving



6 In case of emergency

Spare tyre.....	6-2	Engine overheat.....	6-12
Temporary-use spare tyre	6-2	Tow truck towing	6-13
Flat tyre	6-2	Towing precautions	6-13
Stopping the vehicle	6-2	Recommended towing for two-wheel drive (2WD) models	6-14
Changing flat tyre (Models with spare wheel, where fitted)	6-3	Recommended towing for four-wheel drive (4WD) models	6-14
Repairing flat tyre (Models with emergency tyre puncture repair kit, where fitted)	6-7	Towing eye	6-15
Jump-starting	6-10	Freeing the vehicle from sand, snow or mud	6-15
Push-starting	6-12		

تلفن شبانه روزی: ۰۲۱-۸۸۶۲۰۸۵

FarmaSOS.com

SPARE TYRE

TEMPORARY-USE SPARE TYRE



Temporary-use spare tyre label

The temporary-use spare tyre is designed for emergency use only. This spare tyre should be used ONLY for very short periods and NEVER be used for long drives or extended periods.

Observe the following precautions if the temporary-use spare tyre must be used, otherwise your vehicle could be damaged or involved in an accident.

WARNING

Any continuous road use of this tyre could result in tyre failure, loss of vehicle control, and possible personal injury.

CAUTION

- The temporary-use spare tyre should be used only in emergencies. It should be replaced by the standard tyre at the first opportunity.
- Drive carefully and do not drive your vehicle faster than 80 km/h (50 MPH).

- Avoid driving over obstacles. Also, do not take the vehicle through an automatic car wash.
 - Avoid driving sharp turns and abrupt braking.
 - Do not exceed the vehicle's maximum load rating or the load-carrying capacity molded on the sidewall of the temporary-use spare tyre.
 - Do not use a snow chain on this tyre because it will not fit properly. This could cause damage to the vehicle and result in loss of the chain.
 - Do not use the temporary-use spare tyre on any other vehicle because this tyre has been designed specifically for your vehicle.
 - The vehicle must not be driven with more than one temporary-use spare tyre at the same time.
 - Do not tow a trailer.
 - As with all tyres, the temporary-use spare tyre must be checked regularly to ensure pressure is maintained.
- For pressure details, see the tyre placard located on the driver's side centre pillar.

FLAT TYRE

In case of a flat tyre, follow the instructions as described below:

STOPPING THE VEHICLE

WARNING

- Make sure that the handbrake is securely applied.
- For Manual Transmission (MT) models: Make sure the gear lever is in the R (Reverse) position.

For Automatic Transmission (AT) or Continuously Variable Transmission (CVT) models: Make sure that the selector lever is in the P (Park) position.

- Never change tyres when the vehicle is on a slope, ice or a slippery area. This is hazardous.
- Never change tyres if oncoming traffic is close to your vehicle. Wait for professional road assistance.

1. Safely move the vehicle off the road, away from traffic.
2. Switch on the hazard warning flashers.
3. Park on a level surface.
4. Apply the handbrake.
5. Shift the gear lever (MT models) into the R (Reverse) position [AT or CVT models, move the selector lever to the P (Park) position].

6-2 In case of emergency



6. Turn off the engine.
7. Open the bonnet (for details, see "Bonnet release" in the "3. Pre-driving checks and adjustments" section) in order to:
 - Warn other traffic.
 - Signal to professional road assistance that you require assistance.
8. Have all passengers exit the vehicle and stand in a safe place, away from traffic and clear of the vehicle.

CHANGING FLAT TYRE (Models with spare wheel, where fitted)

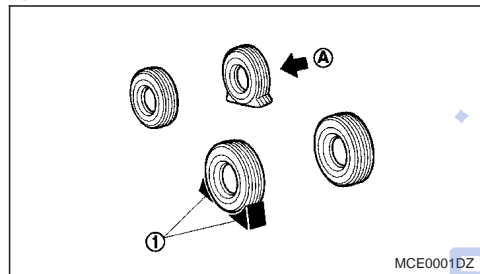

Blocking the wheels



WARNING

Make sure to block the appropriate wheel to prevent the vehicle from moving, which may cause personal injury.

Place suitable blocks ① in front of and behind the wheel diagonally opposite the flat tyre (A) to prevent the vehicle from moving when it is on the jack.

Getting the tools and spare wheel

The spare wheel, jack and tools are located inside the luggage compartment.

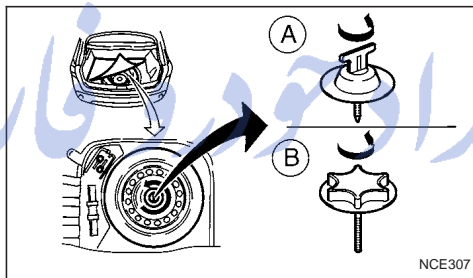

without subwoofer

(A) Type A

(B) Type B

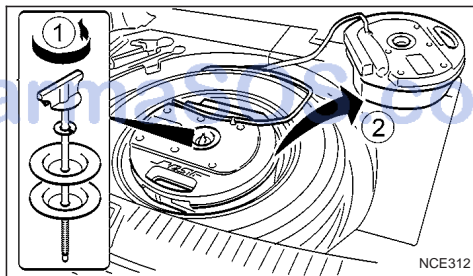

5-seater, with subwoofer (where fitted)

5-seater:

1. Open the back door.
2. Remove the luggage compartment floor cover.
3. Remove the retainer ① by turning it anti-clockwise.
4. Carefully remove and place the subwoofer (where fitted) ② on the top right-hand side corner of the luggage floor compartment (with the flat surface facing downwards).

NOTE

Be careful not to drop the subwoofer.

5. Remove the jack, tools and spare wheel.

In case of emergency 6-3

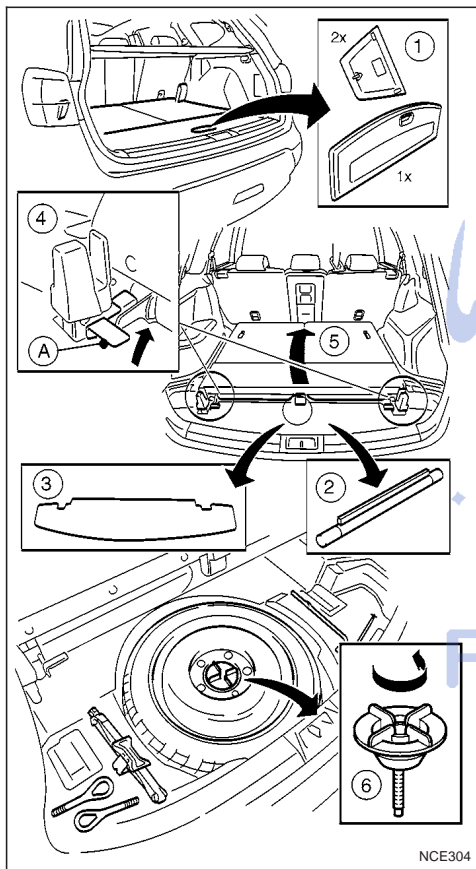

7-seater

7-seater:

1. Open the back door.
2. Remove both sides and centre floor boards ①.
3. Remove tonneau cover (where fitted) ② and floor cover ③. For details, see "Rear parcel shelf (where fitted)" in the "2. Instruments and controls" section.
4. Lower the head restraints and fold the third row seat. For details, see "Seats" in the "1. Safety — seats, seat belts and supplemental restraint system" section.
5. Release the seat from its locking latches (A) by pulling up the two levers simultaneously on both sides ④.
6. Lift up the seat ⑤ and release the levers.
7. Remove the jack, tools and spare wheel.

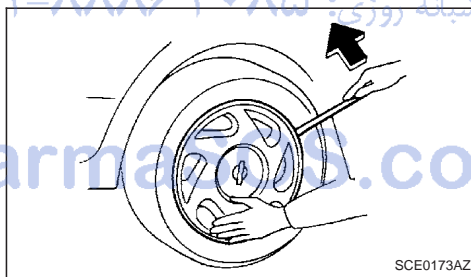

Removing wheel cover (where fitted)



WARNING

Take care when removing the wheel cover as the cover may detach suddenly.

Remove the wheel cover as illustrated with a suitable tool or carefully remove the wheel cover with both hands.

Removing the wheel



WARNING

- Make sure to read the caution label attached to the jack body before use.
- Do not get under a vehicle that is supported only by a jack: Use vehicle support stands.
- Use only the jack that is provided with your vehicle. The jack is designed only for lifting your vehicle during a tyre change.
- Do not use the jack provided with your vehicle on other vehicles.
- Use the correct jack-up points. Never use any other part of the vehicle for jack support.
- Never lift the vehicle more than necessary.
- Never use blocks on or under the jack.
- Do not start or run the engine while the vehicle is on the jack. The vehicle may move suddenly, and this may cause an accident.

6-4 In case of emergency

- Never allow passengers to stay in the vehicle while it is on the jack.
- Remove all loads before lifting the vehicle with the jack.
- Make sure to block the wheel diagonally opposite the flat tyre as described earlier in this section.

CAUTION

The jack should be used on firm, level ground.

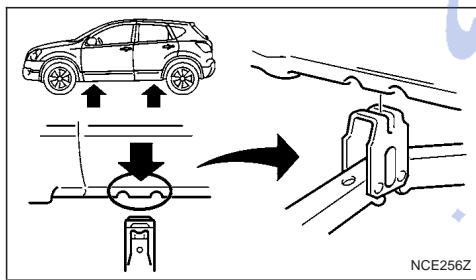

Jack-up points

NCE256Z

1. Place the jack directly under the jack-up point as illustrated so that the top of the jack contacts the vehicle at the jack-up point.
2. Align the centre of both the jack head and the notches at the jack-up point as shown.
3. Fit the groove of the jack head between the two notches as shown.

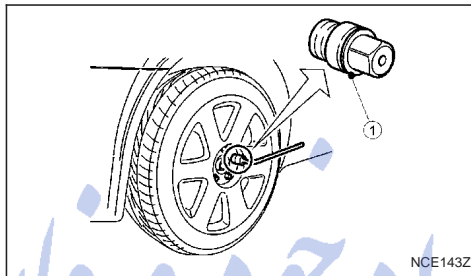

NCE143Z

4. Loosen each wheel nut by one or two turns anticlockwise with the wheel wrench.

Do not remove the wheel nuts until the tyre is off the ground.

Models with wheel lock nuts (where fitted):

If the wheel is equipped with a wheel lock nut, insert the wheel lock key ① and loosen it as previously described.

The wheel lock nut can only be removed with the wheel lock key. A key number is necessary if you need to duplicate the wheel lock key.

Record the key number as shown on the key code card on the "Security information" page at the end of this manual and keep it in a safe place, not in the vehicle. If you lose the wheel lock key, see your NISSAN dealer for a duplicate with the original wheel lock key code.

Make sure to keep the lock key in the vehicle. Otherwise, wheels cannot be removed and the service cannot be performed.

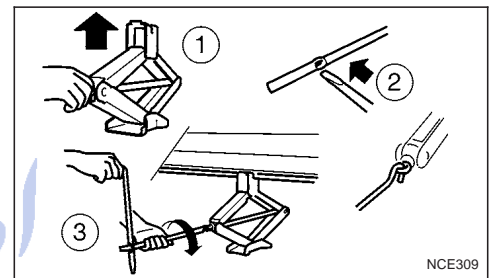

NCE309

5-seater

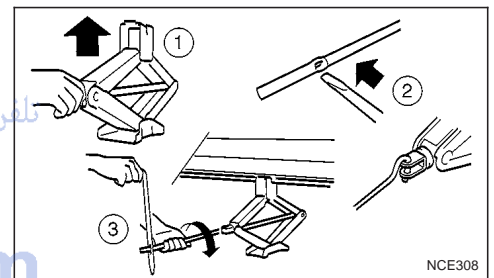

NCE308

7-seater

5. To lift the vehicle, securely hold and turn the handle clockwise as shown.
6. Carefully raise the vehicle until the tyre clears the ground.
7. Remove the wheel nuts, then remove the wheel with the flat tyre.

In case of emergency 6-5

CAUTION

The wheel is heavy. Be sure that your feet are clear of the wheel and use gloves as necessary to avoid injury.

Installing the wheel



WARNING

- The temporary use spare tyre is designed for emergency use. See "Spare tyre" earlier in this section.
- Never use wheel nuts other than those provided with your vehicle. Incorrect wheel nuts or improperly tightened wheel nuts may cause the wheel to become loose or come off. This could cause an accident.
- Never use oil or grease on the wheel studs or nuts. This may cause the wheel nuts to become loose.

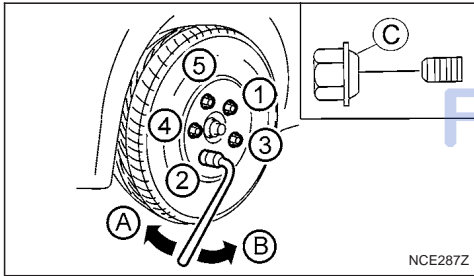

- (A) Tighten
- (B) Loosen
- (C) Bevelled face

1. Clean any mud or dirt from the surface between the wheel and the hub.
2. Carefully fit the wheel and tighten the wheel nuts with your fingers. Check that all the wheel nuts contact the wheel surface horizontally and on the bevelled side.

Models with wheel lock nut (where fitted):

Insert the wheel lock key into the wheel lock nut and tighten into the wheel finger tight.

3. With the wheel wrench, tighten the wheel nuts alternately and evenly in the sequence as illustrated (① - ⑤) until they are tight.
4. Lower the vehicle slowly until the tyre touches the ground.
5. Tighten the wheel nuts securely using the wheel wrench in the sequence as illustrated.
6. Lower the vehicle completely.
7. Install the wheel cover (where fitted).

NOTE

Before installation, align NISSAN logo (centre cap) with the wheel nuts/or perpendicular to valve hole (where fitted), to correctly align to the centre.

As soon as possible, tighten the wheel nuts to the specified torque with a torque wrench.

Wheel nut tightening torque:

113 N•m (12 kg-m, 83 ft-lb)



WARNING

Retighten the wheel nuts after the vehicle has been driven for 1,000 km (600 miles) (also in cases of a flat tyre, etc.).

The wheel nuts must be kept tightened to specification at all times. It is recommended that the wheel nuts be tightened to specification at each maintenance interval.

Adjust the tyre pressure to the COLD pressure.

COLD pressure is the tyre pressure as measured after the vehicle has been parked for three hours or more or driven for less than 1.6 km (1 mile).

COLD tyre pressures are shown on the tyre placard affixed to the driver's side centre pillar.

Stowing the wheel and tools



WARNING

Always make sure that the wheel, subwoofer (where fitted), jack and tools are properly stored after each use. Such items can become dangerous projectiles in an accident or sudden stop.

5-seater

1. Securely store the wheel with the flat tyre, the jack and the tools in the specified storage areas. See "Getting the tools and spare wheel" earlier in this section (for 5-seater).



2. Store the subwoofer (where fitted) as it was originally installed.
3. Install the retainer and replace the floor cover.

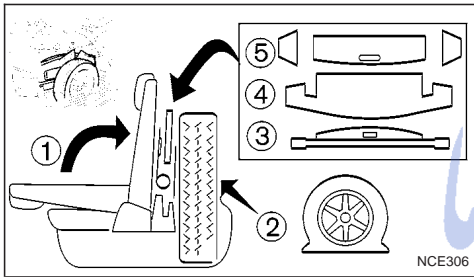

7-seater

1. Store the tools in the specified areas.
2. Firmly pull down the third row seat and make sure it locks into the locking latches on both sides under the seat.
3. Place the seatback of the third row seat in the upright position ①. For details, see "Folding 3rd row (7-seater)" in the "1. Safety — seats, seat belts and supplemental restraint system" section.
4. Store the wheel with flat tyre vertically in the boot ②.
5. Store the other items in following order:
Tonneau cover (where fitted) ③ → Floor cover ④ → Centre floor board and the two side floor boards ⑤.

Wheel lock nuts (where fitted)

In order to prevent theft, the specially designed wheel lock nut is installed to each wheel. The wheel lock nut cannot be removed with the commonly used tools.

When removing tyres, use the lock key provided with your vehicle.

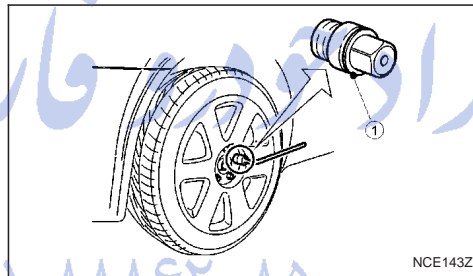

Removing the wheel lock nut:

1. Insert the wheel lock key ① to the wheel lock nut.
2. To remove the wheel lock nut, turn the wheel lock key anticlockwise using the wheel wrench.

CAUTION

- Do not use a power tool to remove the wheel lock nuts.
- When installing the wheel, tighten the wheel lock nuts to the same tightening torque as the

normal wheel nuts. For details, see "Changing flat tyre (Models with spare wheel, where fitted)" earlier in this section.

NOTE

- The wheel lock nut has an individual code. A wheel lock key with other than the individual code cannot remove the wheel lock nut. If you lose the wheel lock key, contact a NISSAN dealer for a duplicate with the original wheel lock key code.
- Record the key number as shown on the key code card on the "Security information" page at the end of this manual and keep it in a safe place, not in the vehicle.
- When you ask for a service at a NISSAN dealer or qualified workshop, make sure to keep the lock key in the vehicle. Otherwise, wheels cannot be removed and the service cannot be performed.

REPAIRING FLAT TYRE (Models with emergency tyre puncture repair kit, where fitted)

The emergency tyre puncture repair kit is supplied with the vehicle instead of a spare tyre. This repair kit must be used for temporarily fixing a minor tyre puncture. After using the repair kit, see a NISSAN dealer or qualified workshop as soon as possible for tyre inspection and repair/replacement.

In case of emergency 6-7

CAUTION

Do not use the emergency tyre puncture repair kit under the following conditions. Contact a NISSAN dealer or qualified workshop or professional road assistance.

- when the sealant has passed its expiration date (shown on the label attached to the bottle)
- when the cut or the puncture is approximately 4 mm (0.16 in) or longer
- when the side of the tyre is damaged
- when the vehicle has been driven with a considerable loss of air from the tyre
- when the tyre is completely displaced inside or outside the rim
- when the tyre rim is damaged
- when two or more tyres are flat

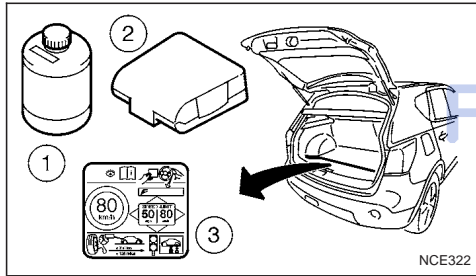

Getting emergency tyre puncture repair kit

Take the emergency tyre puncture repair kit out of the boot. The repair kit consists of the following items:

1. Tyre sealant bottle
2. Air compressor
3. Speed restriction sticker

Before using emergency tyre puncture repair kit

- If any foreign object (for example, a screw or nail) is embedded in the tyre, **do not remove it**.
- Check the expiration date of the sealant (shown on the label attached to the bottle). Never use a sealant which has passed its expiration date.

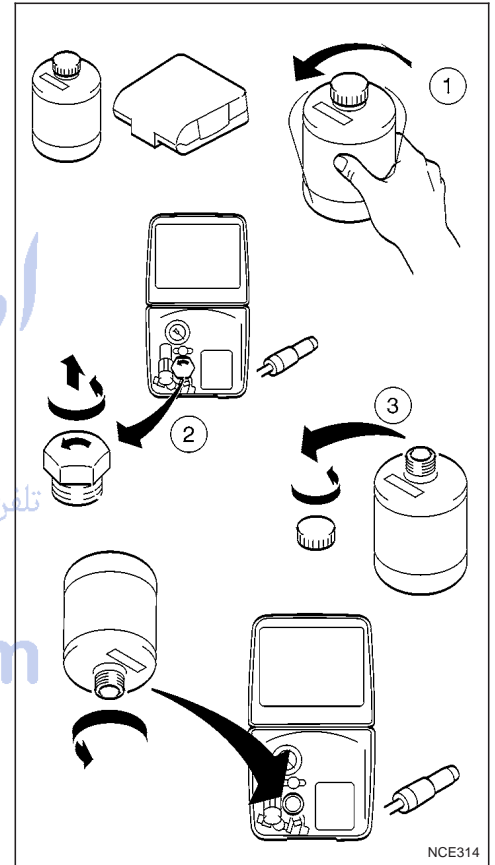

6-8 In case of emergency



Repairing tyre

1. Shake the sealant bottle well.
2. Remove the bottle cap and the orange plug from the top of the compressor.
3. Screw the bottle into the opening of the compressor (where the orange plug was).

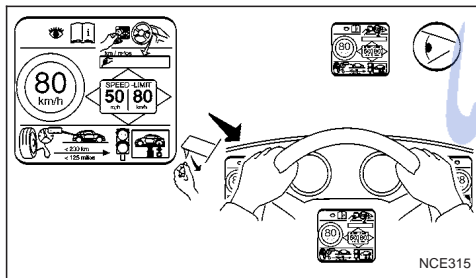

4. Put the speed restriction sticker in a location where the driver can see it while driving.

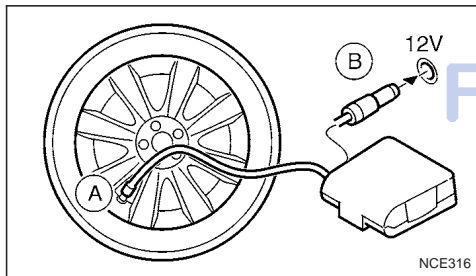

5. Screw the air compressor tube securely into the tyre valve (A).
6. Insert its power plug to the power outlet (B) in the vehicle. For details, see "Power outlet" in the "2. Instruments and controls" section.
7. Turn the ignition switch to the Acc position.
8. Switch on the compressor, and inflate the tyre to the pressure that is specified on the tyre placard affixed to the driver's side centre pillar.

CAUTION

Do not operate the compressor for more than 10 minutes.

If the tyre pressure does not increase to the specified pressure **within 10 minutes**, the tyre may be seriously damaged and **the tyre cannot be repaired with this tyre repair kit**. Contact a NISSAN dealer or qualified workshop.

9. Remove the air compressor from the tyre valve. Immediately drive the vehicle at a speed of 80 km/h (50 MPH) or less.
10. After 10 minute or 5 km (3 mile) drive, check the tyre pressure. The temporary repair is completed if the tyre pressure does not drop.

If the tyre pressure is lower than specified, repeat the steps from step 5.

If the pressure drops again or under 130 kPa (19 psi), **the tyre cannot be repaired with this tyre repair kit**. Contact a NISSAN dealer or qualified workshop.

After repairing tyre

See a NISSAN dealer or qualified workshop for tyre repair/replacement as soon as possible.

JUMP-STARTING

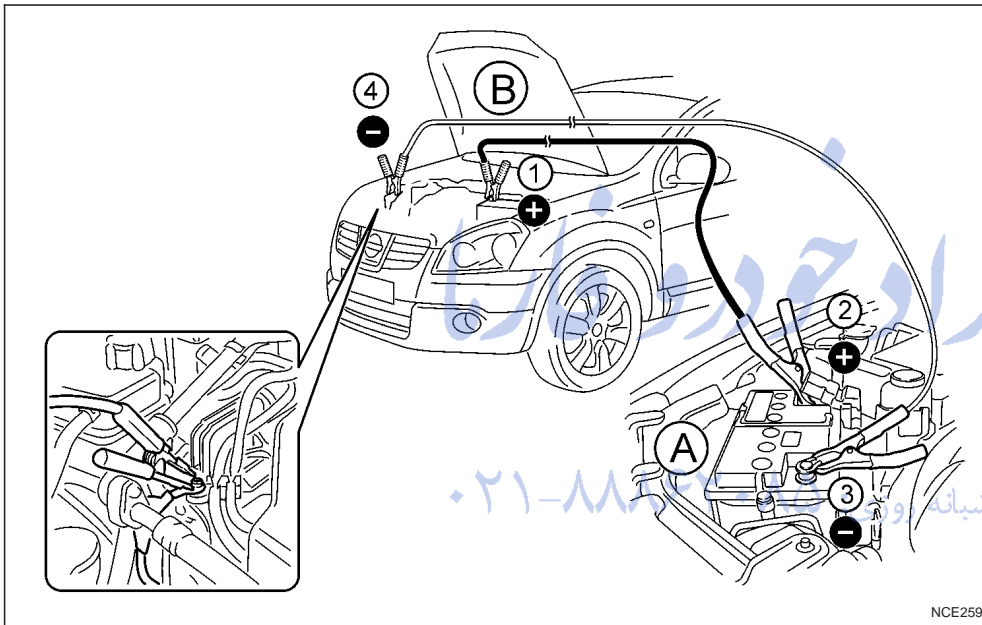

WARNING

- Incorrect jump-starting can lead to a battery explosion. The battery explosion may result in severe injury or death. It may also result in damage to the vehicle. Be sure to follow the instructions in this section.

- Explosive hydrogen gas is always present in the vicinity of the battery. Keep all sparks and flames away from the battery.
- Always wear suitable eye protection glasses and remove rings, bracelets, and any other jewellery whenever working on or near a battery.

- Never lean over the battery while jump-starting.
 - Never allow battery fluid to come into contact with eyes, skin, clothes or the vehicle's painted surfaces. Battery fluid is a corrosive sulphuric acid which can cause severe burns. If the fluid comes into contact with anything, immediately flush the contacted area with plenty of water.
 - Keep the battery out of the reach of children.
 - The booster battery must be rated at 12 volts. Use of an incorrectly rated battery will damage your vehicle.
 - Never attempt to jump-start a frozen battery. It could explode and cause serious injury.
1. Prepare vehicle (A) with the booster battery for the vehicle (B) being jump-started.

CAUTION

Do not allow the two vehicles to touch.

2. Apply the handbrake.
3. Shift the gear lever (MT models) into the N (Neutral) position [AT or CVT models, move the selector lever to the P (Park) position].
4. Switch off all unnecessary electrical systems (headlights, hazard lights etc.).
5. Ensure that the ignition switch of the vehicle being jump-started is in the LOCK position.

6-10 In case of emergency



6. Open the bonnet. For details, see "Bonnet release" in the "3. Pre-driving checks and adjustments" section.
7. Remove the vent caps (where fitted) on the battery and cover the battery with an old cloth.
8. Connect the jump leads in the sequence (① → ② → ③ → ④) as illustrated.

CAUTION

- Always connect positive (+) to positive (+) and negative (-) to body ground (for example, engine lift bracket, etc.) – not to the battery's negative (-).
 - An incorrect connection could damage the charging system.
 - Be sure that the jumper cables do not touch moving parts in the engine compartment.
 - Be careful not to allow contact between the positive jump lead connector and the vehicle or the negative lead during connection and disconnection.
9. Start the engine of the other vehicle (A) and let it run for a few minutes. Keep the engine speed at about 2,000 rpm.
 10. Start the engine of your vehicle (B) in the normal way.

CAUTION

Do not keep the starter motor engaged for more than 10 seconds. If the engine does not start immediately, turn the ignition switch to "OFF" and wait 10 seconds before trying again.

11. After starting the engine of your vehicle, carefully disconnect the negative lead and then the positive lead (④ → ③ → ② → ①).
12. Remove and dispose of the cloth that was used to cover the vent holes as it may be contaminated with corrosive acid.
13. Install the vent caps (where fitted).
14. Close the bonnet.

NOTE

For models which incorporate the Stop/Start System:

- Ensure that the battery fitted is the special battery that is enhanced with regard to the charge-discharge capacity and life performance. Avoid using any other battery for the Stop/Start System, as this may cause early deterioration of the battery or a malfunction of the Stop/Start System. It is recommended that a Genuine NISSAN battery is fitted. For more information, contact a NISSAN dealer or qualified workshop

- If the battery terminal is disconnected (for battery replacement, etc.) and then reconnected, there may be some delay before the Stop/Start System reactivates.

PUSH-STARTING

CAUTION

- Three-way catalyst equipped models should not be started by pushing the vehicle as the three-way catalyst may be damaged.
- Automatic transmission (AT) or continuously variable transmission (CVT) models cannot be started by pushing the vehicle. This may cause transmission damage.
- Never try to start the vehicle by towing it; when the engine starts, the forward surge could cause the vehicle to collide with the tow vehicle.

ENGINE OVERHEAT



WARNING

- Never continue driving if the engine of your vehicle overheats. Doing so could cause a vehicle fire.
- Never open the bonnet if steam is coming out.
- Never remove engine coolant reservoir cap when the engine is hot. If the engine coolant reservoir cap is removed while the engine is hot, pressurised hot water will spurt out and possibly cause burning, scalding or serious injury.
- If steam or coolant is coming out of the engine, stand clear of the vehicle to prevent getting injured.
- The engine cooling fan will start whenever the coolant temperature exceeds preset degrees.
- Be careful not to allow your hands, hair, jewellery or clothing to come into contact with, or get caught in, the cooling fan or drive belts.

If the engine of your vehicle is overheating (indicated by the engine coolant temperature gauge) or if you feel a lack of engine power, detect unusual noise, etc., proceed as follows:

1. Move and park the vehicle safely off the road and away from traffic.
2. Turn on the hazard warning flasher lights.
3. Apply the handbrake.

4. Shift the gear lever (MT models) into the N (Neutral) position [AT or CVT models, move the selector lever to the P (Park) position].

DO NOT STOP THE ENGINE.

5. Open all windows.
6. Switch off the air conditioner system (where fitted).
7. Set the heater or air conditioner temperature control to maximum "HOT" and fan speed control to maximum speed.
8. Exit the vehicle.
9. Visually inspect and listen for steam or coolant escaping from the radiator before opening the bonnet. Wait until no steam or coolant can be seen before proceeding.
10. Open the bonnet. For details, see "Bonnet release" in the "3. Pre-driving checks and adjustments" section.
11. Visually check if the cooling fan is running.
12. Visually check the radiator and radiator hoses for leakage.



WARNING

If coolant is leaking, the cooling fan belt is missing or loose or the cooling fan is not running, stop the engine.

13. After the engine cools down, check the coolant level in the engine coolant reservoir with the engine running.



TOW TRUCK TOWING

14. If the level is low, remove the engine coolant reservoir cap and add coolant slowly into the reservoir. After refilling the reservoir to the MAX level, install the reservoir cap.



WARNING

Before removing the engine coolant reservoir cap and to avoid the danger of being scalded, cover the reservoir cap with a rag and loosen the reservoir cap to the first notch to allow the steam to escape.

15. Close the bonnet.

Have your vehicle inspected or repaired by a NISSAN dealer or qualified workshop.

When towing your vehicle, local regulations for towing must be followed. Incorrect towing equipment could damage your vehicle. To assure proper towing and to prevent accidental damage to your vehicle, NISSAN recommends that you have a service operator tow your vehicle. It is advisable to have the service operator carefully read the following precautions.



WARNING

- Do not allow any occupants in the vehicle that is being towed.
- Never get under your vehicle after it has been lifted by a tow truck.

TOWING PRECAUTIONS

- **When towing:** Make sure that the transmission, axles, steering system and power train are in working condition. If any unit is damaged, the vehicle must be towed using a dolly or be placed on a flat bed lorry.
- Release the handbrake and shift the manual transmission (MT), automatic transmission (AT) or continuously variable transmission (CVT) into the N (Neutral) position before starting to tow the vehicle.
- Always attach safety chains before towing.

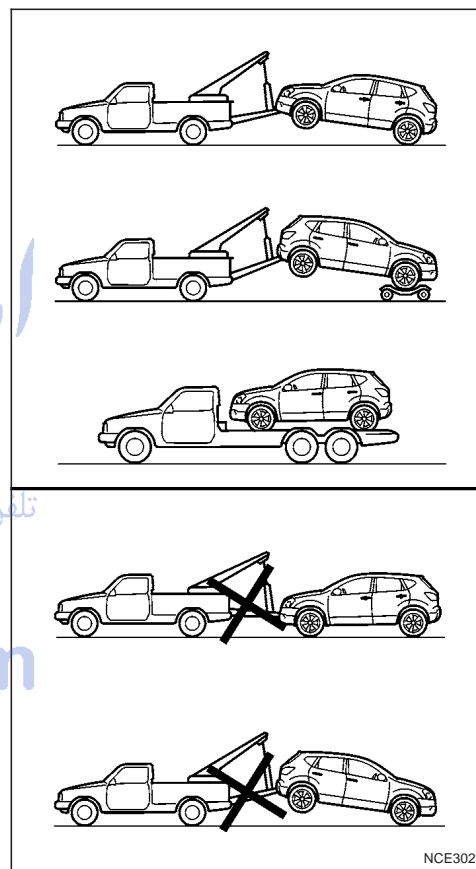

2WD models

NCE302

In case of emergency 6-13

RECOMMENDED TOWING FOR TWO-WHEEL DRIVE (2WD) MODELS

CAUTION

NEVER tow automatic transmission (AT) or continuously variable transmission (CVT) models with the front wheels on the ground or with all four wheels on the ground (forwards or backwards), this may cause serious and expensive damage to the transmission. If it is necessary to tow the vehicle with the rear wheels raised, always use towing dollies under the front wheels.

NISSAN recommends that your vehicle should be towed with the driving (front) wheels off the ground or that the vehicle be placed on a flat bed lorry as illustrated.

When towing with the front wheels – on the ground (MT models only) or – on towing dollies:

Turn the ignition switch to the "OFF" position, then secure the steering wheel in a straight ahead position using a rope or similar device. **Never place the ignition switch in the LOCK position.** This will result in damage to the steering lock mechanism.

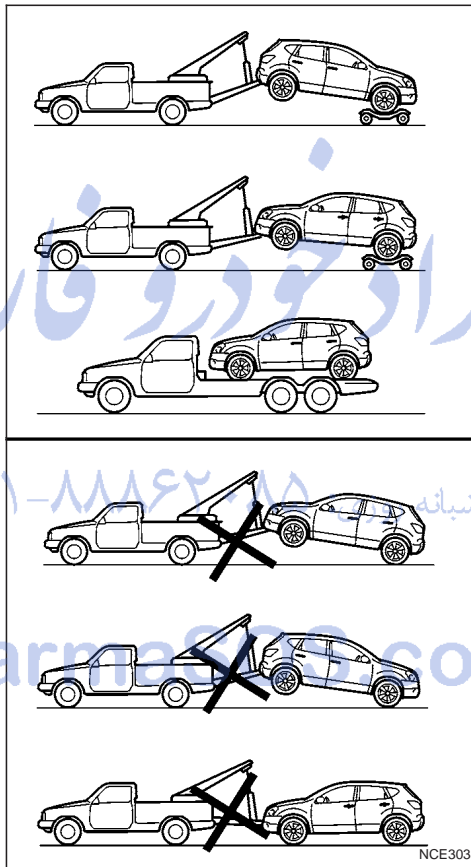

4WD models

RECOMMENDED TOWING FOR FOUR-WHEEL DRIVE (4WD) MODELS

CAUTION

NEVER tow the vehicle with any wheels on the ground as this may cause serious and expensive damage to the transmission.

NISSAN recommends that towing dollies be used when towing your vehicle or that the vehicle be placed on a flat bed lorry as illustrated.

When towing with the front wheels on towing dollies:

Turn the ignition switch to the "OFF" position, then secure the steering wheel in a straight ahead position using a rope or similar device. **Never place the ignition switch in the LOCK position.** This will result in damage to the steering lock mechanism.



TOWING EYE

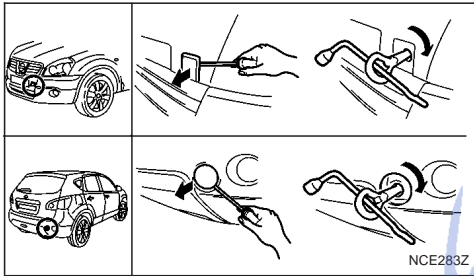

The towing eye is stored with the vehicle tools and located in the spare wheel recess (luggage compartment area).

- 1) Remove the cover from the bumper.
- 2) Securely install the towing eye, as illustrated.

Make sure that the towing eye is properly stored in its designated location after use.

FREEING THE VEHICLE FROM SAND, SNOW OR MUD



WARNING

- Never allow anyone to stand near the towing line during the pulling operation.
- Never spin the tyres at high speed. This could cause them to explode and result in serious injury. Parts of the vehicle could also overheat and be damaged.

Towing eye usage

The towing eye should be used in the event that your vehicle becomes trapped in sand, snow or mud, and is unable to drive away without being pulled, use the towing eye.

- Use the towing eye **only**, not other parts of the vehicle. Otherwise, the vehicle body will be damaged.
- **Only** use the towing eye to free a vehicle stuck in sand, snow, mud, etc.
- Never tow the vehicle for a long distance using only the towing eye.
- The towing eye is under tremendous force when used to free a stuck vehicle. Always pull the cable straight out from the front of the vehicle. Never pull on the towing eye at a sideways angle.

CAUTION

In order not to break the towing line, tension it slowly.

FarmaSOS.com

NOTE

امداد خودرو فارما

تلفن شبانه روزی: ۰۲۱-۸۸۸۶۲۰۸۵

FarmaSOS.com

6-16 In case of emergency



7 Appearance and care

Cleaning exterior.....	7-2	Monitor display's maintenance (where fitted)	7-4
Washing.....	7-2	Floor mats	7-4
Removing spots.....	7-2	Cleaning Glass.....	7-4
Waxing.....	7-2	Plastic parts.....	7-4
Cleaning glass.....	7-3	Seat belts	7-4
Cleaning rear-view camera (where fitted)	7-3	Corrosion protection.....	7-5
Underbody	7-3	Most common factors contributing to vehicle	
Care of wheels	7-3	corrosion	7-5
Cleaning alloy wheels	7-3	Environmental factors influence the rate of	
Chrome parts	7-3	corrosion	7-5
Cleaning interior	7-4	To protect your vehicle from corrosion	7-5

تلفن شبانه روزی: ۰۸۵-۸۸۶۲-۲۱

FarmaSOS.com

CLEANING EXTERIOR

In order to maintain the appearance of your vehicle, it is important to take proper care of it.

Whenever possible, park your vehicle inside a garage or in a covered area to minimise the chances of damaging the paint surface of your vehicle.

When it is necessary to park outside, park in a shady area or protect the vehicle with a body cover. **Be careful not to scratch the paint surface when putting on or removing the body cover.**

WASHING

In the following instances, wash your vehicle as soon as possible to protect the paint surface:

- After a rainfall, to prevent possible damage from acid rain.
 - After driving on coastal roads.
 - When contaminants such as soot, bird droppings, tree sap, metal particles or insects get on the paint surface.
 - When dust or mud builds up on the paint surface.
1. Wash the vehicle surface with a wet sponge and plenty of water.
 2. Clean the vehicle surface gently and thoroughly using a mild soap or a special vehicle wash shampoo mixed with clean, lukewarm (never hot) water.

CAUTION

- **Do not wash the vehicle with strong household soap, strong chemical detergents, petrol or solvents.**
- **Do not wash the vehicle in direct sunlight or while the vehicle body is hot, as the paint surface may become water-spotted.**
- **Avoid using tight-napped or rough cloths, such as washing mitts. Care must be taken when removing caked-on dirt or other foreign substances so the paint surface is not scratched or damaged.**

3. Rinse the vehicle thoroughly with plenty of clean water.
4. Use a damp chamois to dry the paint surface to avoid leaving water spots.

When washing the vehicle, take care of the following:

- Inside flanges, joints and folds on the doors, back door and bonnet are particularly vulnerable to the effects of road salt. Therefore, these areas must be cleaned regularly.
- Be sure that the drain holes in the lower edge of the doors are not clogged.
- Spray water to the underbody and in the wheel wells to loosen the dirt and/or wash away road salt.

- If using a high pressure washer always follow the recommendations on the equipment (pressure and spraying distance).

CAUTION

Do not spray directly into the engine compartment with a high-pressure washer/hose this could damage the engine.

- If there are damaged areas on the vehicle (e.g. painted bumpers or headlamp assembly), it is not recommended to direct the high pressure jet on to them. Carefully wash these areas by hand.
- Avoid the entry of water into the locks.

REMOVING SPOTS

Remove tar and oil spots, industrial dust, insects, and tree sap as quickly as possible from the paint surface to avoid lasting damage or staining. Special cleaning products are available at a NISSAN dealer or any automotive accessory store.

WAXING

Regular waxing protects the paint surface and helps to retain a new vehicle appearance.

After waxing, polishing is recommended to remove built-up residue.

A NISSAN dealer or qualified workshop can assist you in choosing the appropriate waxing products.

CAUTION

- **Wash your vehicle thoroughly and completely before applying wax to the paint surface.**

7-2 Appearance and care



- Always follow the manufacturer's instructions supplied with the wax.
- Do not use a wax containing any abrasives, cutting compounds or cleaners that may damage the vehicle finish.
- If the vehicle surface cannot polish easily, apply a road tar remover prior to waxing the vehicle.
- Machine compounding or aggressive polishing on a base coat/clear coat paint finish may dull the finish or leave swirl marks.

CLEANING GLASS

Use glass cleaner to remove smoke and dust film from the glass surfaces. It is normal for glass to become coated with a film after the vehicle is parked in the hot sun. Glass cleaner and a soft cloth will easily remove this film.

CLEANING REAR-VIEW CAMERA (where fitted)

Clean the transparent camera cover regularly. If dirt, rain or snow attaches to the cover, the monitor may not display objects clearly.

CAUTION

- Do not use alcohol, benzine or thinner to clean the transparent camera cover. This will cause discoloration. To clean the cover, first use a cloth dampened with diluted mild cleaning agent and then wipe with a dry cloth.

- Do not use body wax on the transparent camera cover.
- When washing the vehicle with a high pressure water spray, make sure not to spray it around the transparent camera cover. Otherwise, water may enter the camera unit causing water condensation on the lens and it may result in a malfunction or an electric shock.

UNDERBODY

In areas where road salt is used in the winter, the vehicle's underbody must be cleaned regularly. This will prevent dirt and salt from building up and causing underbody and suspension corrosion.

Before the winter period and again in the spring, the underseal must be checked and, if necessary, re-treated.

CARE OF WHEELS

- Wash the wheels when washing the vehicle to maintain their appearance.
- Clean the inner side of the wheels when the wheel is changed or the underside of the vehicle is washed.
- Do not use abrasive cleaners when washing the wheels.
- Inspect wheel rims regularly for dents or corrosion. This may cause loss of pressure or damage the tyre bead.

- NISSAN recommends that the road wheels be waxed to protect against road salt in areas where it is used during winter.

CLEANING ALLOY WHEELS

Wash the wheels regularly with a sponge dampened in a mild soap solution, especially during winter in areas where road salt is used. The salt residue from road salt could discolour the wheels if it is not washed off regularly.

CAUTION

Follow the directions as described below in order to avoid staining or discolouring of the wheels.

- Do not use a cleaner that contains strong contents of acid or alkali to clean the wheels.
- Do not apply wheel cleaner when the wheels are hot. The wheel temperature should be the same as ambient temperature.
- Rinse the wheel to completely remove the cleaner within 15 minutes after the cleaner has been applied.

CHROME PARTS

Clean all chrome parts regularly with a nonabrasive chrome polish to maintain the finish.

CLEANING INTERIOR

Occasionally remove loose dust from the interior trim, plastic parts and seats using a vacuum cleaner or soft bristled brush. Wipe the vinyl and leather surfaces with a clean, soft cloth dampened in mild soap solution, then wipe clean with a dry, soft cloth.

Regular care and cleaning is required in order to maintain the appearance of the leather.

Before using any fabric protector, read the manufacturer's recommendations. Some fabric protectors contain chemicals that may stain or bleach the seat material.

Use a soft cloth dampened only with water to clean the meter and gauge lens covers.

CAUTION

- **Never use benzine, thinner or any similar material.**
- **Small dirt particles can be abrasive and damaging to leather surfaces and should be removed promptly. Do not use saddle soap, car waxes, polishes, oils cleaning fluids, solvents, detergents or ammonia based cleaners as they may damage the leather's natural finish.**
- **Never use fabric protectors unless recommended by the manufacturer.**
- **Do not use glass or plastic cleaner on meter or gauge lens covers. It may damage the lens covers.**

MONITOR DISPLAY'S MAINTENANCE (where fitted)

- To clean the display screen, first turn the ignition off and wipe it with a dry soft cloth.
- Never use a rough cloth, alcohol, benzine, thinner, any kind of solvent, or paper tissues with chemical cleaning agent. They would scratch or deteriorate the panel.
- Do not splash any liquid such as water or car fragrance on the display. Contact with liquid will cause the system to malfunction and damage the hardware.
- In case of extreme stain, use a small amount of neutral detergent with a soft cloth. Never soak the screen display with water detergent.

FLOOR MATS

The use of NISSAN floor mats can extend the life of your vehicle carpet and make it easier to clean the interior. Regardless of what mats are used, be sure they are fitted for your vehicle and are properly positioned in the foot well to prevent interference with pedal operation. Mats should be maintained with regular cleaning and replaced if they become excessively worn.

CLEANING GLASS

Use glass cleaner to remove smoke and dust film from the glass surfaces. It is normal for glass to become coated with a film after the vehicle is parked in the hot sun. Glass cleaner and a soft cloth will easily remove this film.

CAUTION

When cleaning the inside of the windows, do not use sharp-edged tools, abrasive cleaners or chlorine-based disinfectant cleaners. They could damage elements in the rear windows (such as the window defogger).

Inside rear-view mirror (Automatic anti-dazzling, where fitted)

Use a soft cloth dampened only with water to clean the automatic anti-dazzling inside rear view mirror (where fitted).

CAUTION

Do not use glass cleaner. Doing so will reduce the sensitivity of the sensor, resulting in improper operation.

PLASTIC PARTS

Plastic parts can be cleaned with a mild soap solution. If the dirt cannot be easily removed, use a plastic cleaner. Do not use any solvents.

SEAT BELTS



WARNING

- **Do not allow wet seat belts to roll up in the retractor.**
- **Never use bleach, dye or chemical solvents to clean the seat belts, since these materials may severely weaken the seat belt webbing.**



CORROSION PROTECTION

The seat belts can be cleaned by wiping them with a sponge dampened in a mild soap solution.

Allow the belts to dry completely in the shade before using them.

MOST COMMON FACTORS CONTRIBUTING TO VEHICLE CORROSION

- The accumulation of moisture-retaining dirt and debris in body panel sections, cavities, and other areas.
- Damage to the paint surface and other protective coatings caused by gravel and stone chips or minor traffic accidents.

ENVIRONMENTAL FACTORS INFLUENCE THE RATE OF CORROSION

Moisture

Accumulation of sand, dirt and water on the vehicle body underside can accelerate corrosion. Wet floor coverings will not dry completely inside the vehicle, and should be removed for drying to avoid floor panels corrosion.

Relative humidity

Corrosion will be accelerated in areas of high relative humidity, especially those areas where the temperatures stay above freezing, where atmospheric pollution exists and road salt is used.

Temperature

A temperature increase will accelerate the rate of corrosion to those parts which are not well ventilated.

Corrosion will also accelerate in areas where the temperatures stay above freezing.

Air pollution

Industrial pollution, the presence of salt in the air in coastal areas, or heavy road salt use will accelerate the corrosion process. Road salt will also accelerate the disintegration of paint surfaces.

TO PROTECT YOUR VEHICLE FROM CORROSION

- Wash and wax your vehicle often to keep the vehicle clean.
- Always check for minor damage to the paint surface and if any exists, repair it as soon as possible.
- Keep the drain holes at the bottom of the doors and back door opened to avoid water accumulation.
- Check the vehicle underbody for accumulation of sand, dirt or salt. If present, wash with water as soon as possible.

CAUTION

- **Never remove dirt, sand or other debris from the passenger compartment by washing it out with a hose. Remove dirt with a vacuum cleaner or broom.**
- **Never allow water or other liquids to come in contact with electronic components inside the vehicle as this may damage them.**

Chemicals used for road surface de-icing are extremely corrosive. They accelerate corrosion and deterioration of underbody components such as the exhaust system, fuel and brake lines, brake cables, floor pan and fenders.

In the winter, the underbody must be cleaned periodically.

For additional protection against rust and corrosion, which may be required in some areas, consult a NISSAN dealer or qualified workshop.

امداد خودرو فارما

تلفن شبانه روزی: ۰۲۱-۸۸۸۶۲۰۸۵

FarmaSOS.com



NOTE

امداد خودرو فارما

تلفن شبانه روزی: ۰۲۱-۸۸۸۶۲۰۸۵

FarmaSOS.com

Appearance and care 7-7



8 Maintenance and do-it-yourself

Maintenance requirements	8-2	Integrated keyfob/Intelligent Key battery replacement.....	8-19
Scheduled maintenance.....	8-2	Drive belts	8-21
General maintenance	8-2	Spark plugs (Petrol engine models).....	8-21
Where to go for service	8-2	Air cleaner filter.....	8-21
General maintenance	8-2	Viscous paper type	8-22
Explanation of general maintenance items	8-2	Dry paper type (where fitted)	8-22
Maintenance precautions	8-4	Wiper blades	8-22
Engine compartment.....	8-5	Cleaning.....	8-22
Engine cooling system	8-6	Front window wiper replacement	8-22
Checking engine coolant level.....	8-6	Back door window wiper replacement	8-23
Changing engine coolant	8-6	Windscreen washer nozzle	8-23
Engine oil.....	8-8	Fuses	8-23
Checking engine oil level	8-8	Passenger compartment.....	8-23
Changing engine oil	8-9	Engine compartment.....	8-24
Changing engine oil filter	8-11	Lights	8-25
Protect the environment.....	8-13	Headlights	8-25
Fuel filter (Diesel engine models)	8-13	Exterior lights.....	8-27
Draining water	8-13	Interior lights.....	8-27
Bleeding the fuel system	8-14	Light locations	8-27
Automatic transmission fluid (ATF)	8-14	Wheels and tyres.....	8-31
Continuously variable transmission (CVT) fluid	8-14	Tyre inflation pressure.....	8-31
Brakes.....	8-15	Types of tyres.....	8-31
Checking brake pedal.....	8-15	Snow chains.....	8-32
Checking handbrake.....	8-15	Tyre rotation	8-32
Brake and clutch fluid	8-15	Tyre wear and damage	8-33
Window washer fluid/headlight cleaner fluid (where fitted)	8-16	Tyre age	8-33
Battery.....	8-17	Changing tyres and wheels.....	8-33
Vehicle battery	8-17	Four-wheel drive (4WD) models	8-33
Jump-starting.....	8-19	Wheel balance.....	8-33

Spare tyre 8-33
Care of wheels 8-34

امداد خودرو فارما

تلفن شبانه روزی: ۰۲۱-۸۸۸۶۲۰۸۵

FarmaSOS.com

MAINTENANCE REQUIREMENTS

Your new NISSAN has been designed to have minimum maintenance requirements with longer service intervals, to save you both time and money. However, some day-to-day and regular maintenance is essential to maintain your NISSAN's good mechanical condition, as well as its emission and engine performance.

It is the owner's responsibility to make sure that the specified maintenance, as well as general maintenance, is performed.

As the vehicle owner, you are the only one who can ensure that your vehicle receives the proper maintenance care.

SCHEDULED MAINTENANCE

For your convenience, the required scheduled maintenance items are described and listed in the separate Warranty Information and Maintenance booklet. You must refer to that booklet to ensure that necessary maintenance is performed on your NISSAN vehicle at regular intervals.

GENERAL MAINTENANCE

General maintenance includes those items which should be checked during normal day-to-day operation of the vehicle. They are essential if your vehicle is to continue to operate properly. It is your responsibility to perform these procedures regularly as prescribed.

Performing general maintenance checks requires minimal mechanical skill and a few general automotive tools.

8-2 Maintenance and do-it-yourself

These checks or inspections can be done by yourself, a qualified technician or, if you prefer, your NISSAN dealer or qualified workshop.

WHERE TO GO FOR SERVICE

If maintenance service is required or your vehicle appears to malfunction, have the systems checked and tuned by an authorised NISSAN dealer or qualified workshop.

GENERAL MAINTENANCE

During the normal day-to-day operation of the vehicle, general maintenance should be performed regularly as prescribed in this section. If you detect any unusual sounds, vibrations or smell, be sure to check for the cause or have a NISSAN dealer or qualified workshop do it promptly. In addition, you should notify a NISSAN dealer or qualified workshop if repairs are required.

When performing any checks or maintenance work, closely observe the "Maintenance precautions" later in this section.

EXPLANATION OF GENERAL MAINTENANCE ITEMS

Additional information on the following items with an asterisk (*) is found later in this section.

The maintenance items listed here should be performed from time to time, unless otherwise specified.

Outside the vehicle

Back door, doors and bonnet:

Check that the back door, all doors and the bonnet operate properly. Also ensure that all latches lock securely. Lubricate hinges and latches if necessary. Make sure that the secondary latch keeps the bonnet from opening when the primary latch is released.

When driving in areas using road salt or other corrosive materials, check for lubrication frequently.

مداد خودرو فارما
شبانہ روزی: ۰۱۵ + ۸۸۶۲ - ۲۱
FarmaSOS.com



Lights*:

Clean the headlights on a regular basis. Make sure that the headlights, stop lights, tail lights, turn signal lights, and other lights are all operating properly and installed securely. Also check headlight aim.

Tyres*:

Check the pressure with a gauge periodically when at a service station (including the spare) and adjust to the specified pressure if necessary. Check carefully for damage, cuts or excessive wear.

Tyre rotation*:

Tyres should be rotated every 10,000 km (6,000 miles) for Two-Wheel Drive (2WD) models and 5,000 km (3,000 miles) for Four-Wheel Drive (4WD) models. However, the timing for tyre rotation may vary according to your driving habits and road surface conditions.

Wheel alignment and balance:

If the vehicle pull to either side while driving on a straight and level road, or if you detect uneven or abnormal tyre wear, there may be a need for wheel alignment. If the steering wheel or seat vibrates at normal highway speeds, wheel balancing may be needed.

Wheel nuts:

When checking the tyres, make sure no wheel nuts are missing, and check for any loose wheel nuts. Tighten if necessary.

Windscreen:

Clean the windscreen on a regular basis. Check the windscreen at least every six months for cracks or other damage. Have a damaged windscreen repaired by a qualified repair facility.

Wiper blades*:

Check for cracks or wear if they do not wipe properly.

Under the bonnet and vehicle

The maintenance items listed here should be checked periodically, e.g. each time you check the engine oil or refuel.

Battery*:

Check if the green indicator on the top of the maintenance free battery is visible. If it is not visible, replace the battery as soon as possible.

Vehicles operated in high temperatures or under severe conditions, check the fluid level frequently.

Brake and clutch fluid level*:

Make sure that the brake and clutch fluid level is between the MAX and MIN lines on the reservoir.

Engine coolant level*:

Check the coolant level when the engine is cold.

Engine drive belts*:

Make sure that the drive belts are not frayed, worn, cracked or oily.

Engine oil level*:

Check the level after parking the vehicle on a level surface and turning off the engine.

Fluid leaks:

Check under the vehicle for fuel, oil, water or other fluid leaks after the vehicle has been parked for a while. Water dripping from the air conditioner after use is normal. If you should notice any leaks or if petrol fumes are evident, check for the cause and have it corrected immediately.

Window washer fluid*:

Check that there is adequate fluid in the tank.

Inside the vehicle

The maintenance items listed here should be checked on a regular basis, such as when performing periodic maintenance, cleaning the vehicle, etc.

Accelerator pedal:

Check the pedal for smooth operation and make sure that the pedal does not catch or require uneven effort. Keep the floor mats away from the pedal.

Brake pedal*:

Check the pedal for smooth operation. If the brake pedal suddenly goes down further than normal, the pedal feels spongy or the vehicle seems to take longer to stop, contact a NISSAN dealer or qualified workshop immediately. Keep the floor mat away from the pedal.

Handbrake*:

Confirm that your vehicle is held securely on a fairly steep hill with only the handbrake applied.

Seats:

Check seat position controls such as seat adjusters, seatback recliner, etc. to ensure they operate smoothly and all latches lock securely in every position. Check that the head restraints move up and down smoothly and the locks hold securely in all latched positions.

Seat belts:

Check that all parts of the seat belt system (e.g. buckles, anchors, adjusters and retractors) operate properly and smoothly, and are installed securely. Check the belt webbing for cuts, fraying, wear or damage. See "Seat belts" in the "1. Safety — seats, seat belts and supplemental restraint system" section for further details.

Steering wheel:

Check for any change in the steering conditions, such as excessive free play, hard steering or strange noises.

Warning lights and audible reminders:

Make sure that all warning/indicator lights and audible reminders are operating properly.

Windscreen defogger:

Check that the air comes out of the defogger outlets properly when operating the heater or air conditioner.

Windscreen wiper and washer*:

Check that the wipers and washer operate properly and that the wipers do not streak.

MAINTENANCE PRECAUTIONS

When performing any inspection or maintenance work on your vehicle, always take care to prevent serious accidental injury to yourself or damage to the vehicle. The following are general precautions which should be closely observed.

- **Park the vehicle on a level surface, apply the handbrake securely and block the wheels to prevent the vehicle from moving. For a manual transmission models, move the gear lever to N (Neutral) position. [For automatic transmission or continuously variable transmission models: move the selector lever to P (Park) position.]**
- **Do not work under the engine bonnet while the engine is hot. Turn off the engine and wait until it cools down.**
- **Be sure to turn the ignition switch to the "OFF" or LOCK position.**

When the ignition switch is in the ON or Acc position, the cooling fan may start to operate suddenly even when the engine is not running. To avoid injury, always disconnect the negative battery cable before working near the engine.

- **If you must work with the engine running, keep your hands, clothing, hair and tools away from moving fans, belts and any other moving parts.**
- **It is advisable to remove ties and any jewelry, such as rings, watches, etc. before working on your vehicle.**

8-4 Maintenance and do-it-yourself

امداد خودرو فارما

تلفن شبانه روزی: ۰۲۱-۸۸۶۲۰۸۵

FarmaSOS.com



ENGINE COMPARTMENT

- If you must run the engine in an enclosed space such as a garage, be sure there is proper ventilation for exhaust gases.
- Do not get under a vehicle that is supported only by a jack: Use vehicle support stands.
- Keep smoking materials, flame and sparks away from fuel and battery.
- Never connect or disconnect either the battery or any transistorised component connector while the ignition switch is in the ON position.
- Never leave the engine or transmission related component harness connector disconnected while the ignition switch is in the ON position.
- On petrol engine models with the multiport fuel injection (MFI) system, the fuel filter or fuel lines should be serviced by a NISSAN dealer or qualified workshop because the fuel lines are under high pressure even when the engine is off.
- Always wear eye protection whenever you work on your vehicle.
- Failure to follow these or other common sense guidelines may lead to serious injury or vehicle damage.

Improperly disposed engine oil and/or other vehicle fluids can pollute the environment. Always conform to local regulations for disposal of vehicle fluid.

This section gives instructions regarding only those items which are relatively easy for an owner to perform.

You should be aware that incomplete or improper servicing may result in operating difficulties or excessive emissions, and could affect your warranty coverage. **If in doubt about any servicing, have it done by your NISSAN dealer or qualified workshop.**

For an overview of the engine compartment, see "Instrument and control layout" in the "0. Illustrated table of contents" section.

 NISSAN GREEN PROGRAM

ENGINE COOLING SYSTEM

WARNING

- Never remove the engine coolant reservoir cap when the engine is hot. Serious burns could be caused by high pressure fluid escaping from the engine coolant reservoir. Wait until the engine and radiator have cooled down.
- Engine coolant is poisonous and should be stored carefully in marked containers out of the reach of children.

The engine cooling system is filled at the factory with a high-quality, year-round and extended life engine coolant. The high quality engine coolant contains the specific solutions effective for the anti-corrosion and the anti-freeze function. Therefore, additional cooling system additives are not necessary.

CAUTION

- When adding or replacing engine coolant, be sure to use Genuine NISSAN engine coolant or equivalent.
- The use of other types of engine coolant may damage the engine cooling system.
- The engine coolant reservoir tank is equipped with a pressure cap, use a Genuine NISSAN cap or its equivalent when replacement is required.

CHECKING ENGINE COOLANT LEVEL

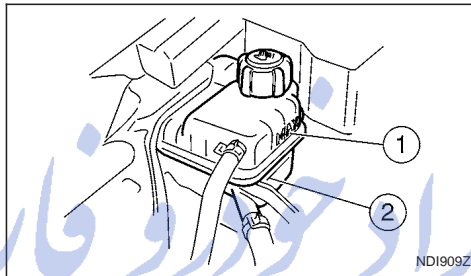

Check the coolant level in the reservoir when the engine is cold. If the coolant level is below MIN ②, add coolant up to the MAX ① level.

CAUTION

If the cooling system frequently requires coolant, have it checked by a NISSAN dealer or qualified workshop.

CHANGING ENGINE COOLANT

CAUTION

- Major cooling system repairs should be performed by a NISSAN dealer or qualified workshop. The service procedures can be found in the appropriate NISSAN Service Manual.
- When checking or replacement is required, NISSAN recommends contacting a NISSAN dealer or qualified workshop for servicing.

- Improper servicing or engine coolant change can result in reduced heater performance and engine overheating.

WARNING

- To avoid the danger of being scalded, never change the coolant when the engine is hot.
- Avoid direct skin contact with used coolant. If skin contact is made, wash thoroughly with soap or hand cleaner and plenty of water as soon as possible.
- Keep coolant out of reach of children and pets.

NISSAN GREEN PROGRAM

Engine coolant must be disposed of properly. Check your local regulations.

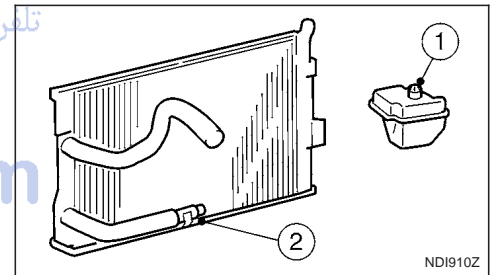

HR16DE, MR20DE, M9R or R9M engine

1. Set the heater or air conditioner temperature control to the maximum "HOT" position.
2. Open the bonnet. For details, see "Bonnet release" in the "3. Pre-driving checks and adjustments" section.
3. Open the engine coolant reservoir cap ① to help to drain the coolant.
4. Disconnect the end of the hose ② to drain the coolant.
5. Flush the cooling system by running clean water through the engine coolant reservoir.
6. Install the hose ②.
7. Fill the coolant reservoir up to the MAX level. See "Capacities and recommended fuel/lubricants" in the "9. Technical information" section for cooling system capacity.
8. Install the engine coolant reservoir cap.
9. Start the engine, and rev the engine two or three times under no load.
10. Touch the radiator hose and feel if the water flows.
11. Keep racing the engine at a speed of 3,000 rpm for about 10 minutes.
12. Observe the coolant temperature gauge for signs of overheating.

13. Stop the engine and check coolant level, allow to cool and refill up to the MAX level.
14. Check radiator lower hose for any signs of leakage.
15. Close the bonnet.

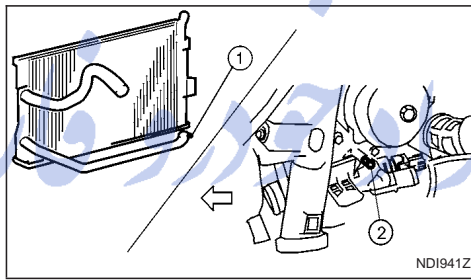

K9K engine

1. Set the heater or air conditioner temperature control to the maximum "HOT" position.
2. Open the bonnet. For details, see "Bonnet release" in the "3. Pre-driving checks and adjustments" section.
3. Disconnect the radiator lower hose ① and open the drain plug ② on the engine block.
4. Open the engine coolant reservoir cap to help to drain the coolant.
5. Flush the cooling system by running fresh water through the engine coolant reservoir.

6. Install the hose and securely tighten the engine block drain plug.
7. Fill the reservoir up to the MAX level with coolant. See "Capacities and recommended fuel/lubricants" in the "9. Technical information" section for cooling system capacity.
8. Install the engine coolant reservoir cap.
9. Start the engine, and rev the engine two or three times under no load.
10. Touch the radiator hose and feel if the water flows.
11. Keep racing the engine at a speed of 2,000 – 2,500 rpm for about 10 minutes.
12. Observe the coolant temperature gauge for signs of overheating.
13. Stop the engine and check coolant level, allow to cool and refill up to the MAX level.
14. Check the radiator lower hose for any signs of leakage.
15. Close the bonnet.

ENGINE OIL

CHECKING ENGINE OIL LEVEL

CAUTION

The oil level should be checked regularly. Operating with an insufficient amount of oil can damage the engine, and such damage is not covered by warranty.

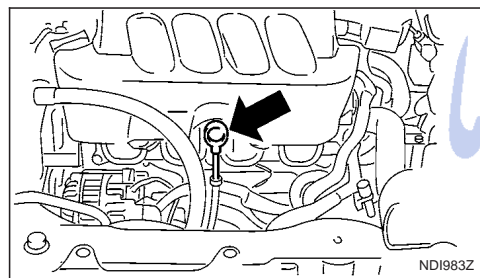

HR16DE or MR20DE engine

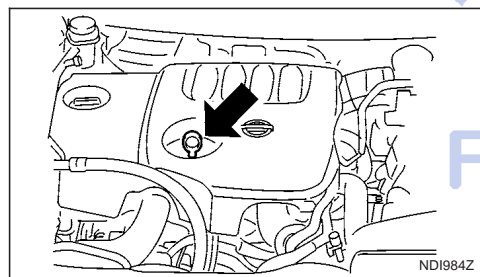

Euro 4 K9K engine

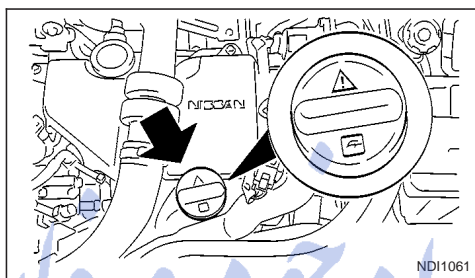

Euro 5 K9K engine

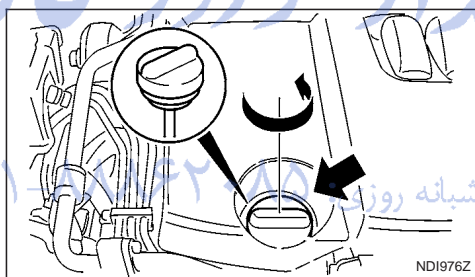

M9R engine

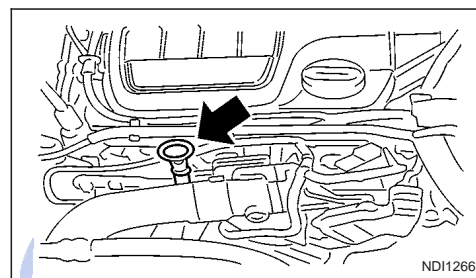

R9M engine

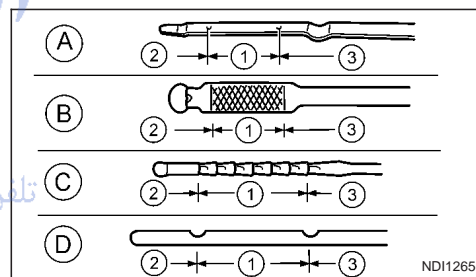

- (A) HR16DE or MR20DE engine
- (B) K9K engine
- (C) M9R engine
- (D) R9M engine
- (1) Normal range
- (2) MIN level
- (3) MAX level

1. Park the vehicle on a level surface and apply the handbrake.
2. Start the engine. If the engine is cold, start and let the engine idle until it reaches the operational temperature.
3. Turn the engine off.
4. Wait at least 10 minutes for the engine oil to drain back into the oil pan.
5. Open the bonnet. For details, see "Bonnet release" in the "3. Pre-driving checks and adjustments" section.
6. Remove the dipstick and wipe it clean.

Models with M9R engine: the engine oil dipstick is attached to the engine oil filler cap. Remove the engine oil filler cap and wipe the dipstick clean.

7. Reinsert it all the way.

Models with M9R engine: install the engine oil filler cap.

8. Remove the dipstick again and check the oil level. It should be in the normal range ①.
9. If the oil level is below MIN ②, remove the engine oil filler cap and pour the recommended oil through the opening. **Do not overfill** ③.
10. Recheck the oil level with the dipstick.
11. Install the engine oil filler cap securely.
12. Close the bonnet.

It is normal to add some engine oil between oil maintenance intervals depending on the severity of operating conditions or depending on the property of the engine oil used. More engine oil is consumed by frequent acceleration/deceleration especially when the engine rpm is high. Consumption is likely to be higher when the engine is new. If the rate of oil consumption, after having driven for 5,000 km (3,000 miles), is more than 0.5 litre per 1,000 km (621 miles), consult a NISSAN dealer or qualified workshop.

CHANGING ENGINE OIL

WARNING

- NISSAN recommends contacting a NISSAN dealer or qualified workshop for engine oil servicing.

NISSAN GREEN PROGRAM

Used oil must not be poured into the ground, canals, rivers, etc. It should be disposed of at a rubbish tip having proper facilities. Check your local regulations.

- Be careful not to burn yourself, as the engine oil is hot.
- Prolonged and repeated contact with used engine oil may cause skin cancer.
- Avoid direct skin contact with used oil. If skin contact is made, wash thoroughly with soap or hand cleaner and plenty of water as soon as possible.

- Store used engine oil in marked containers out of the reach of children.

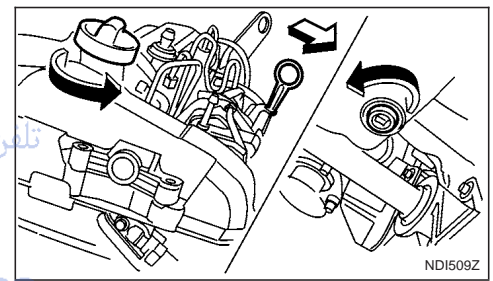
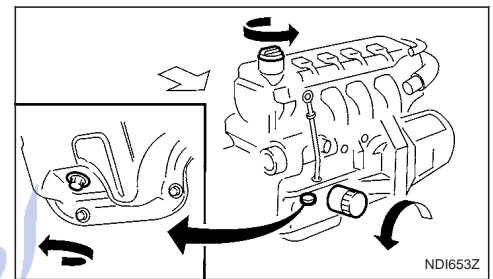

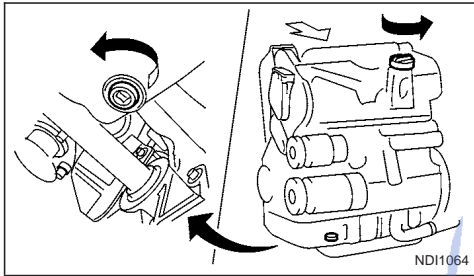

Euro 5 K9K engine

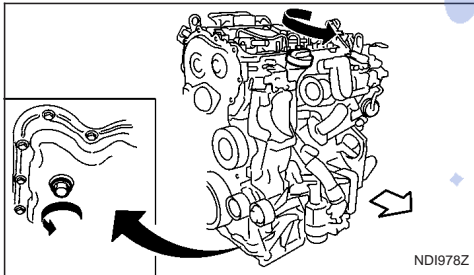

M9R or R9M engine

1. Park the vehicle on a level surface and apply the handbrake.
2. Start the engine. If the engine is cold, start and let the engine idle until the engine temperature reaches the operational temperature.
3. Turn the engine off and wait at least 10 minutes to let the engine oil drain back into the oil pan.

4. Open the bonnet. For details, see "Bonnet release" in the "3. Pre-driving checks and adjustments" section.

5. Remove the engine oil filler cap.

6. Raise and support the vehicle using a suitable floor jack and safety jack stands.

Place the safety jack stands under the vehicle jack-up points.

For details, see "Flat tyre" in the "6. In case of emergency" section.

7. Remove the engine compartment under cover.

8. Place a large drain pan under the drain plug.

9. Remove the drain plug with a wrench and completely drain the oil.

If the engine oil filter needs to be changed, remove and replace it at this time. See "Changing engine oil filter" later in this section.

10. Clean and re-install the drain plug along with a new washer. Securely tighten the drain plug with a wrench. **Do not use excessive force.**

Drain plug tightening torques:

HR16DE, MR20DE engine:
34.3 N•m (3.5 kg-m, 25 ft-lb)

K9K engine:
20 N•m (2.1 kg-m, 15 ft-lb)

M9R engine:
44 N•m (4.5 kg-m, 32 ft-lb)

R9M engine:
50 N•m (5.1 kg-m, 36.9 ft-lb)

11. Refill the engine with recommended engine oil and quantity.

See "Capacities and recommended fuel/lubricants" in the "9. Technical information" section.

12. Check the oil level with the dipstick. For details, see "Checking engine oil level" earlier in this section. If necessary, add engine oil.

13. Install the engine oil filler cap securely.

14. Start the engine.

15. Check for any leakage around the drain plug. Correct as required.

16. Turn the engine off and wait several minutes.

17. Check the oil level again with the dipstick. If necessary, add engine oil.

18. Install the engine compartment under cover.

19. Lower the vehicle carefully to the ground.

20. Close the bonnet.

8-10 Maintenance and do-it-yourself



CHANGING ENGINE OIL FILTER



WARNING

- NISSAN recommends contacting a NISSAN dealer or qualified workshop for engine oil filter servicing.

NISSAN GREEN PROGRAM

A used oil filter should be disposed of at a rubbish tip having proper facilities.

HR16DE, MR20DE or K9K engine

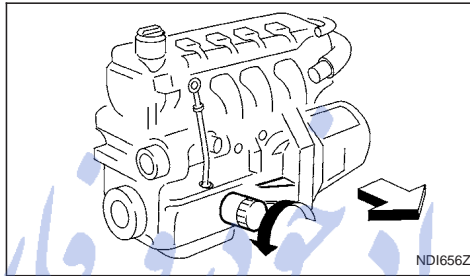

HR16DE or MR20DE engine

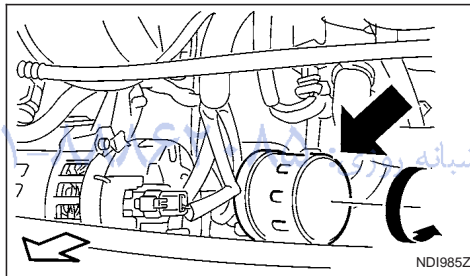

K9K engine

Removal:

1. Drain the engine oil. For details, see "Changing engine oil" earlier in this section.
2. Loosen the engine oil filter unit with an oil filter wrench. Depending on the engine model, a special **cap type** wrench may be required. See a NISSAN dealer or qualified workshop, if in doubt.

3. Remove the engine oil filter unit.
4. Wipe the engine oil filter mounting surface with a clean rag.

CAUTION

If any oil is spilled on the engine or the vehicle, thoroughly wipe it clean.

Installation:

1. Clean and re-install the drain plug along with a new washer. For tightening torque details, see "Changing engine oil" earlier in this section.
2. Coat the rubber gasket on the new engine oil filter unit with clean engine oil.
3. Install the engine oil filter unit by hand until a slight resistance is felt, then tighten additionally 2/3 of a turn.

Engine oil filter tightening torques:

HR16DE, MR20DE engine:
17.7 N•m (1.8 kg-m, 13 ft-lb)

K9K engine:
14 N•m (1.4 kg-m, 10 ft-lb)

4. Add engine oil and check the oil level with the engine oil dipstick. For details, see "Checking engine oil level" earlier in this section and "Capacities and recommended fuel/lubricants" in the "9. Technical information" section.
5. Install the engine oil filler cap.
6. Start the engine.

7. After the engine has been warmed up, make sure there are no leaks around the engine oil filter unit and the drain plug. Correct as required.
8. Turn the engine off and wait several minutes. Check the oil level and add engine oil, if necessary.
9. Install the engine compartment under cover.
10. Lower the vehicle carefully to the ground.
11. Close the bonnet.

M9R or R9M engine

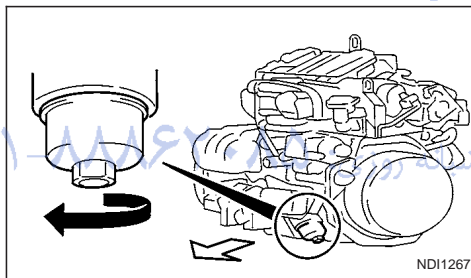
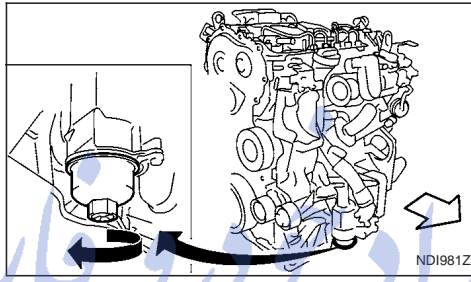

Removal:

1. Drain the engine oil. For details, see "Changing engine oil" earlier in this section.
2. Loosen the engine oil filter cover with a wrench.
3. Remove the engine oil filter cover then the oil filter element.
4. Remove the rubber O-ring from the filter cover.

5. Wipe the oil filter cover entirely with a clean rag.

Installation:

1. Clean and re-install the drain plug along with a new washer. For tightening torque details, see "Changing engine oil" earlier in this section.
2. Install the rubber O-ring, in its housing, on the outside of the engine oil filter cover.
3. Insert the new oil filter element into the engine oil filter cover.
4. Coat the rubber O-ring with clean engine oil.
5. Install the engine oil filter cover until a slight resistance is felt, then tighten additionally 2/3 of a turn.

Tightening torque:

25 N•m (2.6 kg-m, 18 ft-lb)

6. Add engine oil and check the oil level with the engine oil dipstick. For details, see "Checking engine oil level" earlier in this section and "Capacities and recommended fuel/lubricants" in the "9. Technical information" section.
7. Install the engine oil filler cap.
8. Start the engine.
9. After the engine has been warmed up, make sure there are no leaks around the engine oil filter cover and the drain plug. Correct as required.
10. Turn the engine off and wait several minutes. Check the oil level and add engine oil, if necessary.
11. Install the engine compartment undercover.



فارس سوس

تلفن ۰۲۱-۸۸۸۶۲۰۰

FarmaSOS.com

FUEL FILTER (Diesel engine models)

- Lower the vehicle carefully to the ground.
- Close the bonnet.

PROTECT THE ENVIRONMENT

NISSAN GREEN PROGRAM

It is illegal to pollute drains, water courses and soil. Use authorised waste collection facilities, including civic amenity sites and garages providing facilities for the disposal of used oil and used oil filters. If in doubt, contact your local authority for advice on disposal.

The regulations concerning the pollution of the environment will vary from country to country.

DRAINING WATER

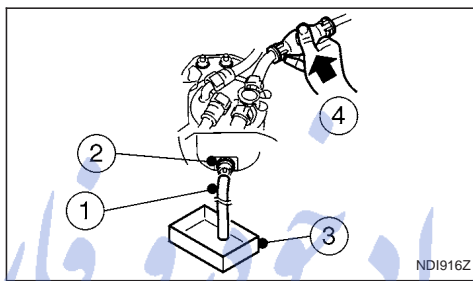

Drain the water from the fuel filter:

- Every time you perform an engine oil change.
- When the water in fuel filter warning light (orange) comes on or flashes irregularly.
- Except for models with R9M diesel engine.

Proceed as follows:

1. Connect a suitable drain hose (1) to the drain plug (2).
2. Place a drain pan (3) under the hose (1).
3. Loosen manually the drain plug (2) with 4 to 5 turns and operate the priming pump (4) to drain the water out of the fuel filter.

CAUTION

- The water from the fuel filter is drained with fuel. Prepare a larger capacity pan than the volume of the fuel filter.

- Drained water is mixed with fuel and take precautions to prevent the fuel from adhering to rubber parts such as engine mounting insulator.

4. After draining, close the drain plug manually.

CAUTION

- If the drain plug is tightened excessively, it can be damaged and as a result, fuel will leak.
 - Do not use tools to tighten the drain plug.
5. Bleed air from the fuel system. For details, see "Bleeding the fuel system" later in this section.
 6. Start the engine and make sure there is no fuel leakage. Correct as required.
- For models with R9M diesel engine Contact a NISSAN dealer or qualified workshop.

BLEEDING THE FUEL SYSTEM

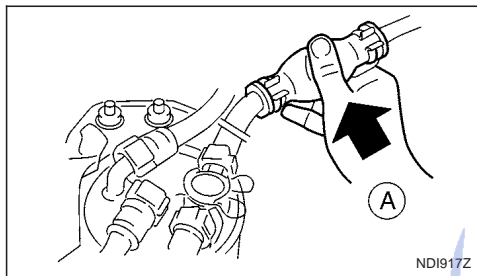

Except for models with R9M engine

- Except for models with R9M diesel engine:
Bleed the air out of the fuel system after refilling an empty fuel tank by the following procedure:
 1. Squeeze the priming bulb (A) several times until there is a sudden resistance felt in the pressure, then stop.
 2. Crank the engine until the engine starts.

CAUTION

Do not crank the engine for more than 30 seconds.

NOTE

- If the engine does not start, stop cranking and repeat step 1 of the procedure.
- If the engine does not operate smoothly after it has started, race it two or three times.
- For models with R9M diesel engine:
Contact a NISSAN dealer or qualified workshop.

AUTOMATIC TRANSMISSION FLUID (ATF)

When checking or replacement is required, NISSAN recommends contacting a NISSAN dealer or qualified workshop for servicing.

CAUTION

- Use only Genuine NISSAN ATF Matic Fluid J (or S) or equivalent. Do not mix with other fluids.
- Using automatic transmission fluid other than Genuine NISSAN ATF Matic Fluid J (or S) or equivalent will cause deterioration in drivability and automatic transmission durability, and may damage the automatic transmission, which is not covered by the warranty.

The specified AT fluid is also described on the caution label located under the bonnet. For details, see "Air conditioner specification label (where fitted) and Automatic transmission fluid label (where fitted)" in the "9. Technical information" section.

CONTINUOUSLY VARIABLE TRANSMISSION (CVT) FLUID

When checking or replacement is required, NISSAN recommends contacting a NISSAN dealer or qualified workshop for servicing.

CAUTION

- Use only Genuine NISSAN CVT Fluid NS2. Do not mix with other fluids.
- Using transmission fluid other than Genuine NISSAN CVT Fluid NS2 will damage the CVT transmission, which is not covered by the warranty.

FarmaSOS.com

BRAKES

BRAKE AND CLUTCH FLUID

CHECKING BRAKE PEDAL

If the brake pedal suddenly goes down further than normal, the pedal feels "spongy" or the vehicle seems to take longer to stop, see a NISSAN dealer or qualified workshop.

CHECKING HANDBRAKE

Periodically check the holding ability of the handbrake by parking on a steep hill and restraining the vehicle by using only the handbrake. If it does not hold satisfactorily, see a NISSAN dealer or qualified workshop.

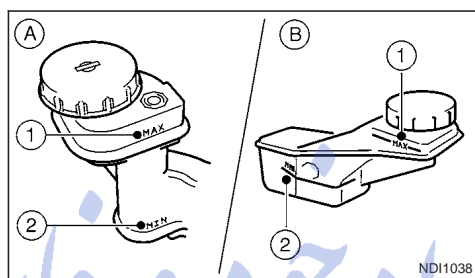

(A) LHD models

(B) RHD models



WARNING

- Use only new fluid. Old, inferior, or contaminated fluid may damage the brake and clutch systems. The use of improper fluids can damage the brake system and affect the vehicle's stopping ability.
- Clean the filler cap before removing.
- Brake and clutch fluids are poisonous and should be stored carefully in marked containers out of the reach of children.

Check the fluid level in the reservoir. If the fluid level is between the MIN (2) and MAX (1) lines or the brake warning light comes on, add fluid up to the MAX line.

See "Capacities and recommended fuel/lubricants" in the "9. Technical information" section for the recommended brake and clutch fluid type.

If fluid must be added frequently, the system should be thoroughly checked by a NISSAN dealer or qualified workshop.

CAUTION

- NISSAN recommends that refilling and checking the brake and clutch systems should be left to a NISSAN dealer or qualified workshop who will have the necessary fluids and technical knowledge.
- Do not spill the fluid on painted surfaces. This will damage the paint. If fluid is spilled, wash with water.

WINDOW WASHER FLUID/HEADLIGHT CLEANER FLUID (where fitted)

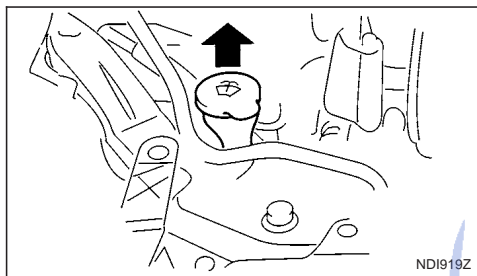

- Always use window washer fluid recommended by NISSAN dealer or qualified workshop.

امداد خودرو فارما

WARNING

Anti-freeze window washer is poisonous and should be stored carefully in marked containers out of the reach of children.

- Check the fluid level in the window washer reservoir. If the fluid level is low, add window washer fluid up to the MAX level.
- Refill the reservoir more frequently when driving conditions require an increased amount of window washer fluid.
- Add a washer solvent to the water for better cleaning. In the winter season, add a window washer anti-freeze. Follow the manufacturer's instructions for the mixture ratio.







تلفن شبانه روزی: ۰۸۵ ۸۸۶۲ ۰۸۱-۲۱
FarmaSOS.com

CAUTION

- Do not substitute anti-freeze engine coolant for window washer solution. This may result in damage to the paint.



BATTERY

Caution symbols for battery		⚠️ WARNING	
①		No smoking No exposed flames No sparks	Never smoke around the battery. Never expose the battery to open flames or electrical sparks.
②		Shield eyes	Handle the battery cautiously. Always wear eye protection glasses to protect against explosion or battery acid.
③		Keep away from children	Never allow children to handle the battery. Keep the battery out of reach of children.
④		Battery acid	Do not allow battery fluid to contact your skin, eyes, fabrics, or painted surfaces. After handling the battery or battery cap, immediately wash your hands thoroughly. If the battery fluid gets into your eyes, or onto your skin or clothing, flush with water immediately for at least 15 minutes and seek medical attention. Battery fluid is acid. If the battery fluid gets into your eyes or onto your skin, it could cause eyesight loss or burns.
⑤		Note operating instructions	Before handling the battery, read this instruction carefully to ensure correct and safe handling.
⑥		Explosive gas	Hydrogen gas, generated by battery fluid, is explosive.

VEHICLE BATTERY

⚠️ WARNING

Do not operate the vehicle if the fluid in the battery is low. Low battery fluid can cause a higher load on the battery which can generate heat, reduce battery life, and in some cases lead to an explosion.

- Keep the battery surface clean and dry. Any corrosion should be washed off with a solution of baking soda and water.
- Make certain the terminal connections are clean and securely tightened.
- If the vehicle is not used for 30 days or longer, disconnect the “-” negative battery terminal cable to prevent discharge.
- If battery replacement or check is required, contact a NISSAN dealer or qualified workshop.

Battery (Type A)

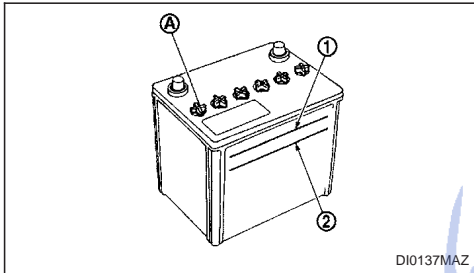

Check the fluid level in each cell. It should be between the UPPER ① and LOWER ② level lines.

If it is necessary to add fluid, add only distilled water to bring the level to the indicator in each filler opening. **Do not overfill.**

1. Remove the cell plugs (A) using a suitable tool.

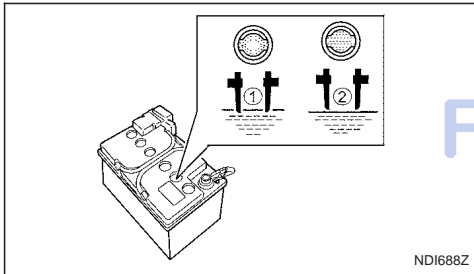

① OK

② ADD

2. Add distilled water up to the UPPER level line ①.

If the side of the battery is not clear, check the electrolyte water level by looking directly above the cell, as illustrated.

3. Tighten cell plugs.

CAUTION

Do not overfill battery cells. Excessive electrolyte may leak out of the battery during charging, and cause paint damage.

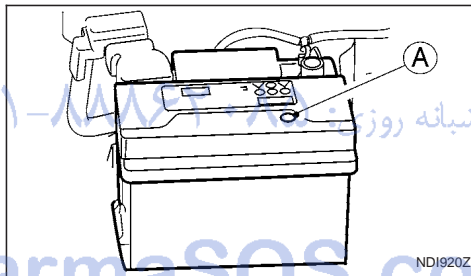

Maintenance free battery (Type B)

For a maintenance free battery it is not required to check the fluid level. However, NISSAN recommends to visually check the green indicator (A) status periodically. If it is not visible, replace the battery as soon as possible.

Reinitialisation procedure after battery reconnection

If the battery has been reconnected, check the following items:

- Re-enter the anti-theft system code (where fitted). For details, see the separately provided NISSAN Connect Owner's Manual.
- Clock setting. For details, see "Vehicle information display" in the "2. Instruments and controls" section or the separately provided NISSAN Connect (where fitted) Owner's Manual.
- The C-View® sunshade or power window system may need to be reinitialised. For details, see "C-View® glass roof (where fitted)" in the "2. Instruments and controls" section or "Windows" in the "2. Instruments and controls" section.

Models with Stop/Start System

- Ensure that the battery fitted is the special battery that is enhanced with regard to the charge-discharge capacity and life performance. Avoid using any other battery for the Stop/Start System, as this may cause early deterioration of the battery or a malfunction of the Stop/Start System. It is recommended that a Genuine NISSAN battery is fitted. For more information, contact a NISSAN dealer or qualified workshop.
- If the battery terminal is disconnected (for battery replacement, etc.) and then reconnected, there may be some delay before the Stop/Start System reactivates.



JUMP-STARTING

If jump-starting is necessary, see "Jump-starting" in the "6. In case of emergency" section. If the engine does not start by jump starting, the battery may have to be replaced. Contact a NISSAN dealer or qualified workshop.

INTEGRATED KEYFOB/INTELLIGENT KEY BATTERY REPLACEMENT

CAUTION

- Be careful not to touch a circuit board or a battery terminal.

NISSAN GREEN PROGRAM

An improperly disposed battery can harm the environment. Always conform to local regulations for battery disposal.

- The Integrated keyfob/Intelligent Key is water-resistant; however, if it does get wet, immediately wipe it until it gets completely dry. To replace the battery, open the Integrated keyfob/Intelligent Key carefully in the sequence shown in the illustration.
- When changing the battery, do not let dust or oil get on the Integrated keyfob/Intelligent Key.

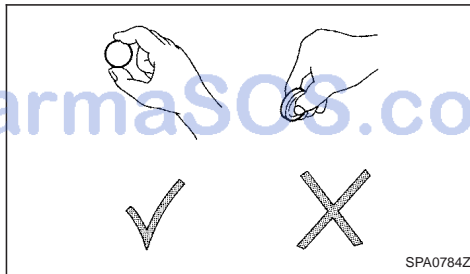

CAUTION

Always hold the battery by the edges, as shown. Holding the battery across the contact points will seriously deplete the storage capacity.

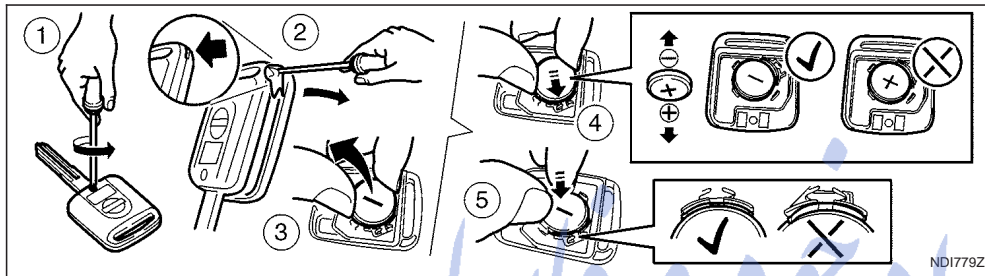

Integrated keyfob

NDI779Z

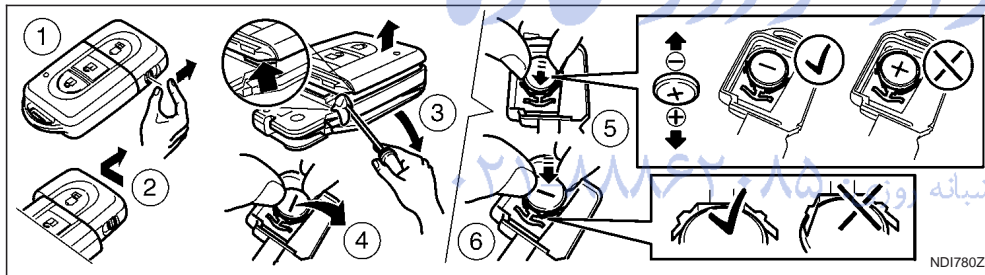

Intelligent Key

NDI780Z

Replacement

1. Integrated keyfob:

Use a cross-shaped screwdriver to remove the screw before opening the lid.

Intelligent Key:

- a. Slide the locking pin to the unlock position.
- b. Remove the Intelligent Key cap as illustrated.

2. Insert a flat blade screwdriver or a suitable tool into the slit of the corner and twist it to open the lid.

3. Replace the battery with a new one.

For models equipped with Integrated keyfob, use the following battery type:

CR2016

For models equipped with Intelligent Key, use the following battery type:

CR2032

- Do not touch the internal circuit and electric terminals as doing so could cause a malfunction.
- Make sure that the + side faces the bottom of the case, as illustrated.

4. Install the lid in the reverse order of removal.

5. Operate the buttons to check its operation.

Contact a NISSAN dealer or qualified workshop if you need assistance for battery replacement.

FarmaSOS.com



DRIVE BELTS



WARNING

Be sure the ignition switch is in the "OFF" or LOCK position. Otherwise the cooling fan or the engine may start to operate suddenly.

1. Visually inspect each belt for signs of unusual wear, cuts, fraying or looseness. If the belt is in poor condition or loose, have it replaced or adjusted by a NISSAN dealer or qualified workshop.
2. Have the belts checked regularly for condition and tension in accordance with the maintenance schedule as shown in a separately provided Warranty Information and Maintenance booklet.

SPARK PLUGS (Petrol engine models)



WARNING

Be sure the engine and ignition switch are off and that the handbrake is engaged securely.

CAUTION

- Be sure to use the correct socket to remove the spark plugs. An incorrect socket can cause damage to the spark plugs.
- Always replace spark plugs with recommended or equivalent ones.

Replace spark plugs according to the maintenance schedule shown in the separately provided Warranty Information & Maintenance Booklet.

If replacement is required, see a NISSAN dealer or qualified workshop for servicing.

AIR CLEANER FILTER

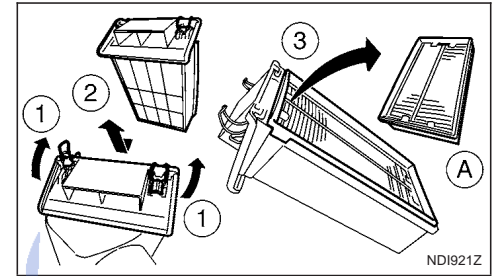

Type A

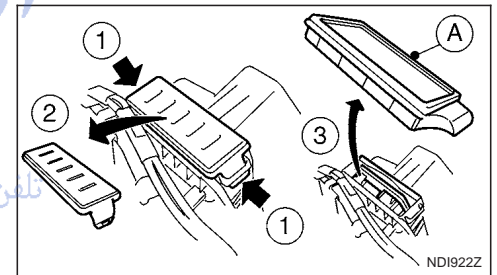

Type B



WARNING

- Operating the engine without the air cleaner filter, can cause you or others to be burned. The air cleaner filter not only cleans the intake air, it also stops flame if the engine backfires. If the air cleaner filter is not installed and the engine backfires, you could be burned.
- Do not drive without the air cleaner filter.

WIPER BLADES

- Be careful when working on the engine without the air cleaner filter.

VISCOUS PAPER TYPE

The filter element (A) should not be cleaned and reused.

Replace it according to the maintenance schedule shown in the separately provided Warranty Information & Maintenance Booklet. When replacing the filter, wipe the inside of the air cleaner housing and the cover with a damp cloth.

DRY PAPER TYPE (where fitted)

Check the filter element (A) to see if it is dirty. If it is dirty, shake the element to remove dust.

Clean or replace it according to the maintenance schedule shown in the separately provided Warranty Information & Maintenance Booklet. When cleaning or replacing the filter, wipe the inside of the air cleaner housing and the cover with a damp cloth.

CLEANING

If the windscreen or back door window is not clear after using the window washer or if a wiper blade chatters when running, wax or other material may be on the blade or windscreen.

Clean the outside of the windscreen or back door window with a washer solution or a mild detergent. The windscreen or back door window is clean if beads do not form when rinsing with clear water.

Clean the blade by wiping it with a cloth soaked in a washer solution or a mild detergent. Then rinse the blade with clear water. If the windscreen or back door window is still not clear after cleaning the blades and using the wiper, replace the blades.

CAUTION

- After wiper blade replacement, return the wiper arm to its original position. Otherwise it may be damaged when the bonnet is opened.
- Make sure the wiper blade contacts the glass. Otherwise, the arm may be damaged from wind pressure.
- Do not open the bonnet when the front wiper is in the servicing position otherwise it can damage the paint surface of the bonnet.

FRONT WINDOW WIPER REPLACEMENT

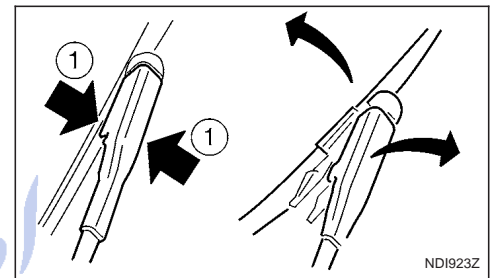

1. Pull up the wiper arm.
2. Press the two side lock pins (1), then remove the wiper blade as illustrated.
3. Install the new wiper blade in the reverse order of removal.
4. Return the wiper arm to its original position.

BACK DOOR WINDOW WIPER REPLACEMENT

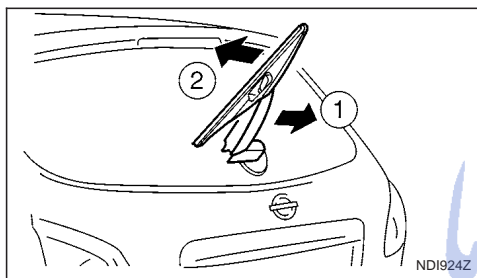

1. Lift the wiper arm.
2. Hold and rotate carefully the wiper blade clockwise until the blade becomes free.
3. Insert the new wiper blade onto the wiper arm and snap it into place.
4. Return the wiper arm to its original position.

WINDSCREEN WASHER NOZZLE

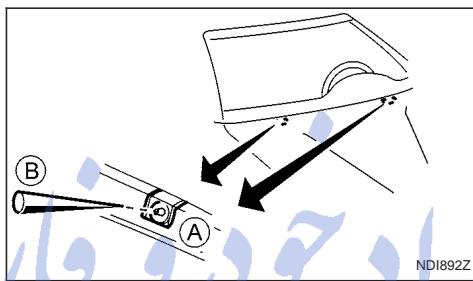

If you wax the surface of the engine bonnet, be careful not to let wax get into the washer nozzle (A). This may cause clogging or improper windscreen washer operation. If wax gets into the nozzle, remove it with a needle or small pin (B).

FUSES

PASSENGER COMPARTMENT

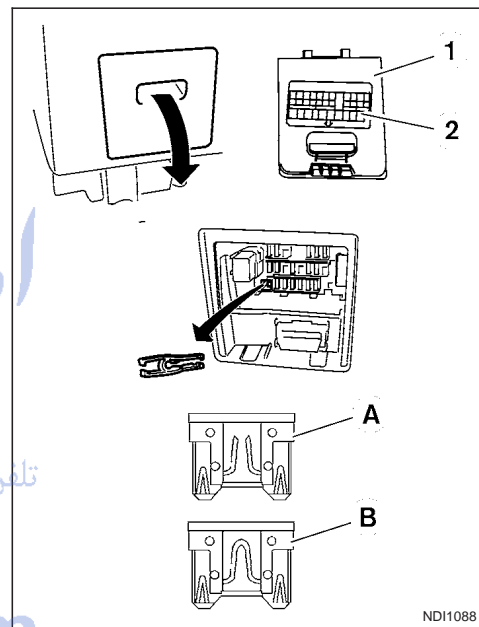

CAUTION

- Never use a fuse of higher or lower amperage rating than that specified on the fuse box cover.
- Never pull the harness or wires when disconnecting the connector.

- **Be careful not to damage the connector support bracket when disconnecting the connector.**

If any electrical equipment does not operate, check for an open fuse.

The fuse box is located in the lower part of the instrument panel at the driver's side.

The affected circuits (2) are shown on the back of the fuse box lid (1).

1. Make sure the ignition switch and the headlight switch are in the "OFF" position.
2. Open the fuse box lid.
3. Locate and remove the fuse with the fuse puller (where fitted).

NOTE

The fuse puller is stored in the fuse box.

4. If the fuse is open (A), replace it with a new fuse (B).
5. Close the fuse box lid.

NOTE

If the new fuse opens again, after installing, have the electrical system checked and repaired by a NISSAN dealer or qualified workshop.

ENGINE COMPARTMENT

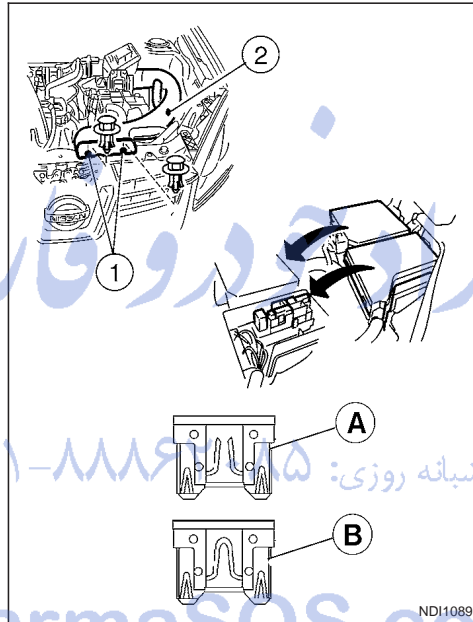

CAUTION

Never use a fuse of higher or lower amperage rating than that specified on the fuse box cover.

If any electrical equipment does not operate, check for an open fuse.

1. Make sure the ignition switch and the headlight switch are in the "OFF" position.
2. Open the bonnet. For details, see "Bonnet release" in the "3. Pre-driving checks and adjustments" section.
3. Remove the clips (1) (where fitted) and air duct (2) (where fitted).
4. Remove the fusible link covers.
5. Locate the fuse that needs to be replaced.
6. Remove the fuse with the fuse puller (where fitted). The fuse puller is located in the fuse box of the passenger compartment.
7. If the fuse is open (A), replace it with a new fuse (B).
8. Install the fusible link covers.
9. Install the air duct and clips (where fitted) in the reverse order of removal.
10. Close the bonnet.

NOTE

If the new fuse opens again, after installing, have the electrical system checked and repaired by a NISSAN dealer or qualified workshop.



LIGHTS

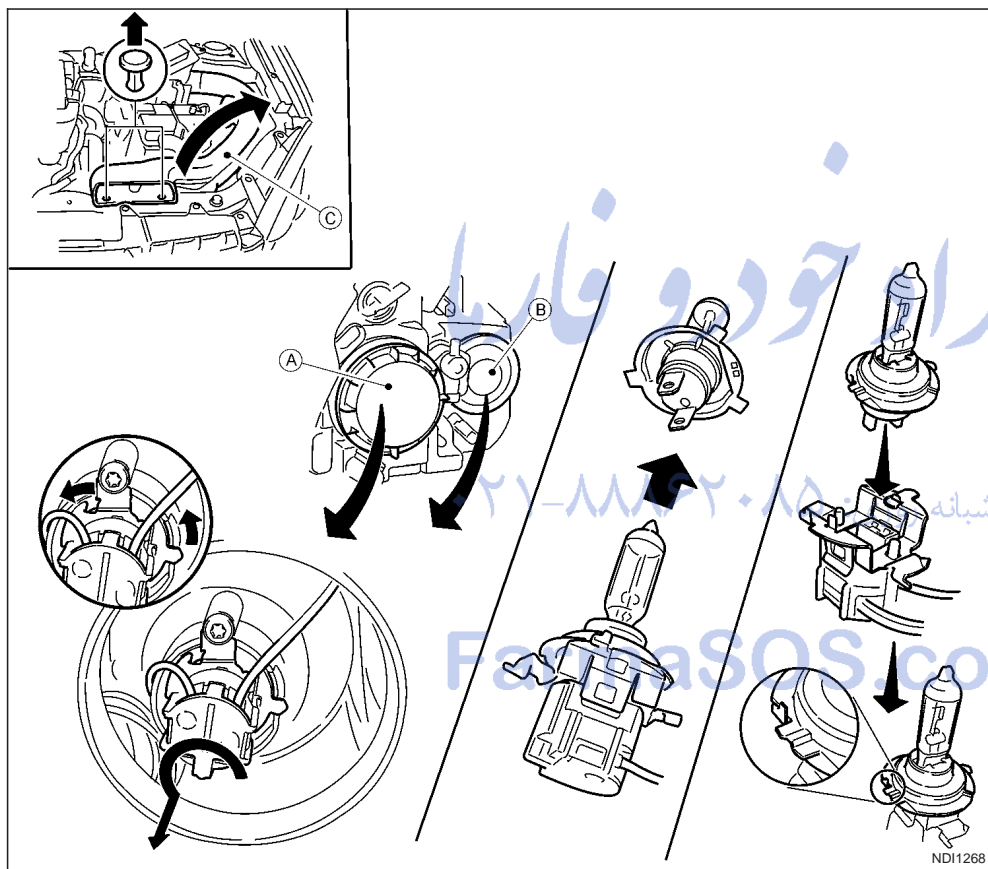

HEADLIGHTS

- (A) Low beam
- (B) High beam
- (C) Air duct

Xenon (low beam) headlight (where fitted)

The gas discharge headlight is a projector style which uses a xenon headlight bulb.

WARNING

HIGH VOLTAGE

- When the xenon headlights are on, they produce a high voltage. To prevent an electric shock, never attempt to modify or disassemble the xenon headlights assembly.
- Should the xenon headlight bulb need to be replaced, have it done **ONLY** by a NISSAN dealer or qualified workshop.

Xenon headlight bulb replacement:

CAUTION

The following safety instructions must be observed when it is necessary to replace the xenon headlight bulb yourself:

- When handling the bulb the necessary precautions should always be taken on account of the high pressure (i.e. wear gloves and safety glasses and use the bulb in a closed headlight, etc).

- Only hold the xenon headlight bulb by the base.
- The bulb is manufactured from high-quality quartz and is under high pressure.
- Damage, soiling, and fingerprints should be avoided and, if necessary, removed with alcohol before installing the bulb.
- When the headlights are switched on, the bulbs produce a certain amount of UV radiation. In order to avoid any impairment of health (burning and conjunctivitis), the bulb should only be used in closed headlights with appropriate UV-absorbing front glass.
- Due to the risk of burning, the bulb should be left to cool down for 3 minutes after switching off before touching.
- Due to the use of mercury and various salts, the bulb should be treated as special waste when discarded.
- The bulb may only be operated with a suitable ballast which produces very high voltages when switched on and during operation.
- Contact with bulb and wires should therefore be avoided and a safe distance of at least 30 mm should be maintained.

Replacing the halogen headlight bulb

CAUTION

- High pressure halogen gas is sealed inside the halogen bulb. The bulb may break if the glass envelope is scratched or the bulb is dropped.
- When handling the bulb, **DO NOT TOUCH THE GLASS ENVELOPE.**
- Use the same number type and wattage as originally installed.
- Aiming is usually not necessary after replacing the bulb. When aiming adjustment is necessary, contact a NISSAN dealer or qualified workshop.
- Do not leave the bulb out of the headlight reflector for a long period of time as dust, moisture or smoke may enter the headlight body and affect the performance of the headlight.

The headlight is a semi-sealed beam type which uses a replaceable headlight (halogen) bulb. A bulb can be replaced from inside the engine compartment without removing the headlight assembly.

Contact a NISSAN dealer or qualified workshop, if you need assistance for bulb replacement.

1. Open the bonnet. For details, see "Bonnet release" in the "3. Pre-driving checks and adjustments" section.
2. Disconnect the negative (–) battery cable.

3. When the broken bulb is located in the headlight assembly under the air duct, carefully remove the clips and rotate the air duct (C) clockwise a 1/4 of a turn.
4. Remove the cap (A) or (B) of the headlight assembly.
5. Turn the connector 1/4 of a turn in the anti clockwise direction and remove the headlight bulb.
6. Install the new bulb in the reverse order of removal and make sure that the cap is securely sealed with the headlight body.
7. Where removed (step 3.), re-install the air duct (C) and clips in the order of removal.
8. Reconnect the negative (–) battery cable and close the bonnet.

NOTE

Fog may temporarily form inside the lens of the exterior lights in the rain or in a car wash. The fog is caused by a temperature difference between the inside and the outside of the lens. This is not a malfunction. If large droplets can be seen, then contact a NISSAN dealer or qualified workshop.



EXTERIOR LIGHTS

Item	Wattage (W)
Headlight (Low or high beam: type H7)	55
Front turn signal light	21
Front side light	5
Front fog light (H11 type, where fitted) *1	55
Side turn signal light	5
Rear combination light	
Turn signal light	21
Stop/Tail light *1	LED
Reverse light *1	21
High-mounted stop light *1	LED
Number plate light	5
Rear fog light	21

*1: If replacement is required, contact a NISSAN dealer or qualified workshop.

INTERIOR LIGHTS

Item	Wattage (W)
Room light/Map lights (where fitted)	5
Foot well light (where fitted)	3
Room light — rear (where fitted)	5
Reading lights — rear (where fitted)	8
Luggage compartment light (where fitted)	5

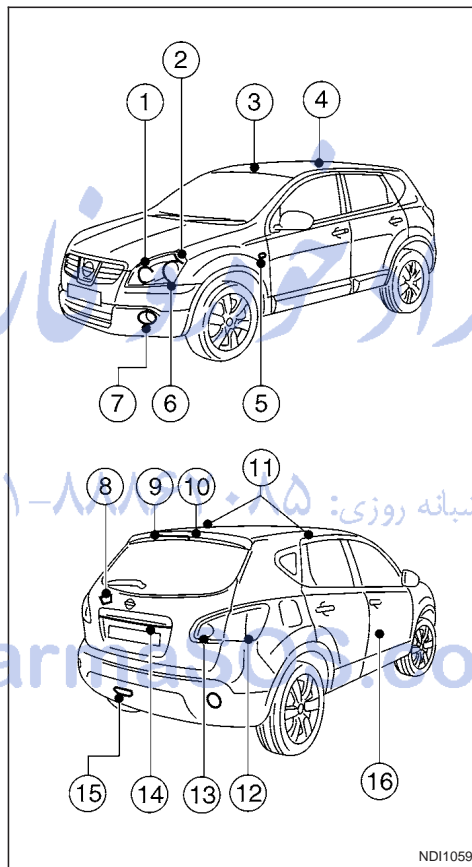

LIGHT LOCATIONS

- ① Front side light
- ② Front turn signal light
- ③ Room light/Map lights (where fitted)
- ④ Reading light – type A (where fitted)
- ⑤ Side turn signal light
- ⑥ Headlights
- ⑦ Front fog light (where fitted)
- ⑧ Luggage compartment light (where fitted)
- ⑨ High mounted stop light
- ⑩ Room light (where fitted)
- ⑪ Reading lights (where fitted)
- ⑫ Rear combination light
- ⑬ Reverse light
- ⑭ Number plate light
- ⑮ Rear fog light
- ⑯ Footwell light (where fitted)

Replacing procedures

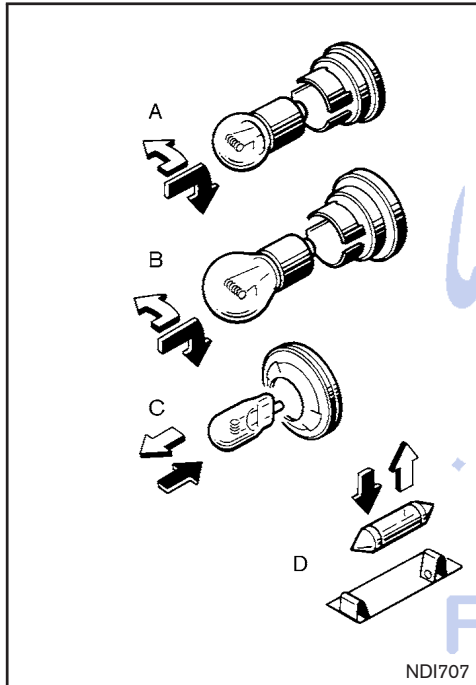

All other lights are either type A, B, C or D.
When replacing a bulb, first remove the lens
and/or cover.

⇨ REMOVE

➔ INSTALL



Front side light

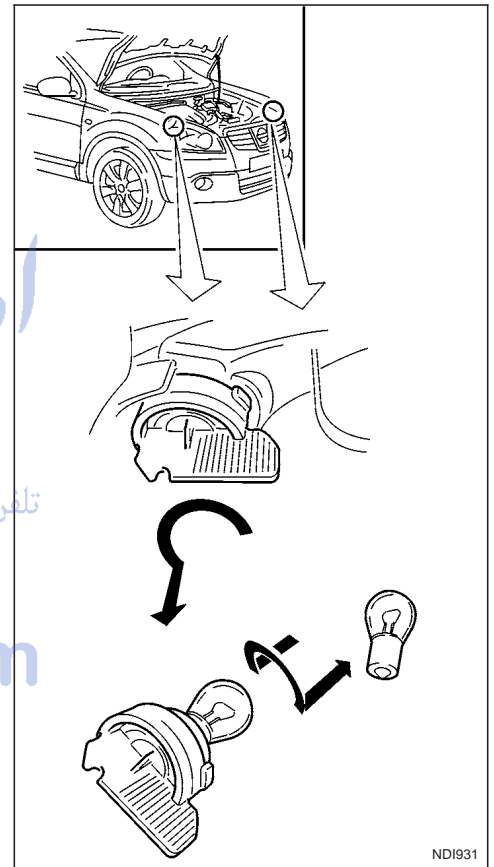

Front turn signal light



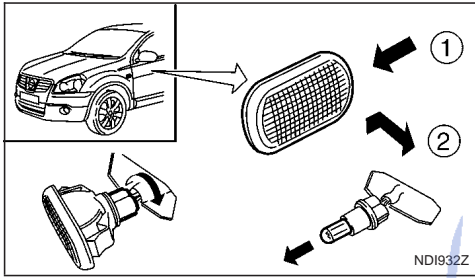

Side turn signal light

NDI932Z

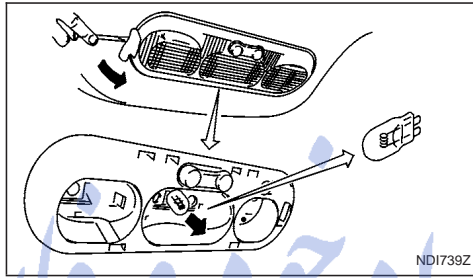

Room light – rear (where fitted)

NDI739Z

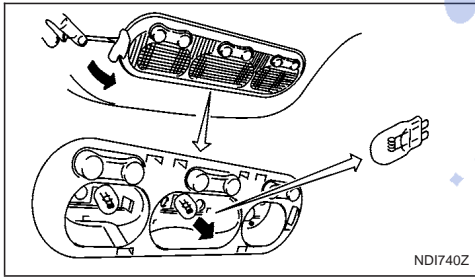

Room light/Map lights (where fitted)

NDI740Z

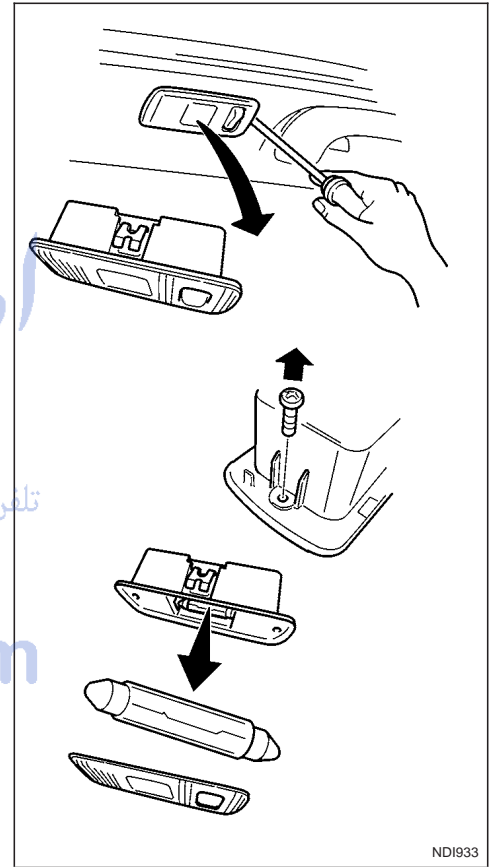

Reading light – rear (where fitted)

NDI933

تلفن شبانه روزی: ۰۲۱-۸۸۶۲۰۸۵

FarmaSOS.com

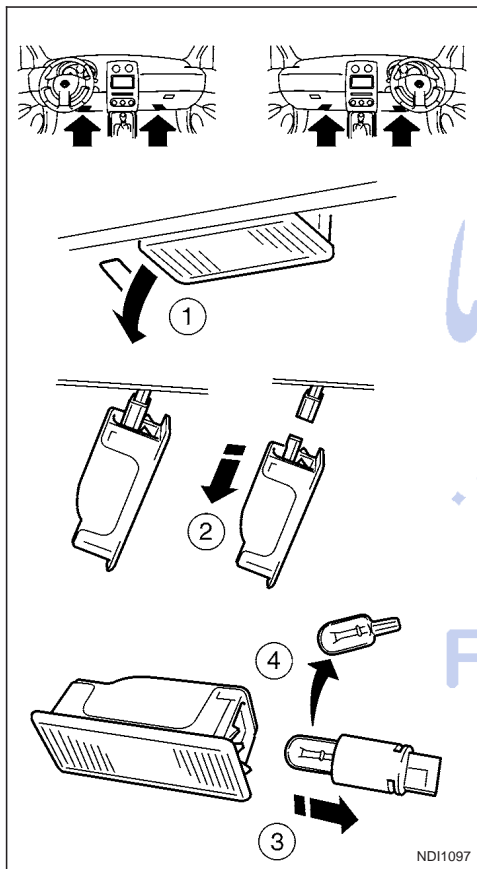

Foot well light (where fitted)



Luggage compartment light

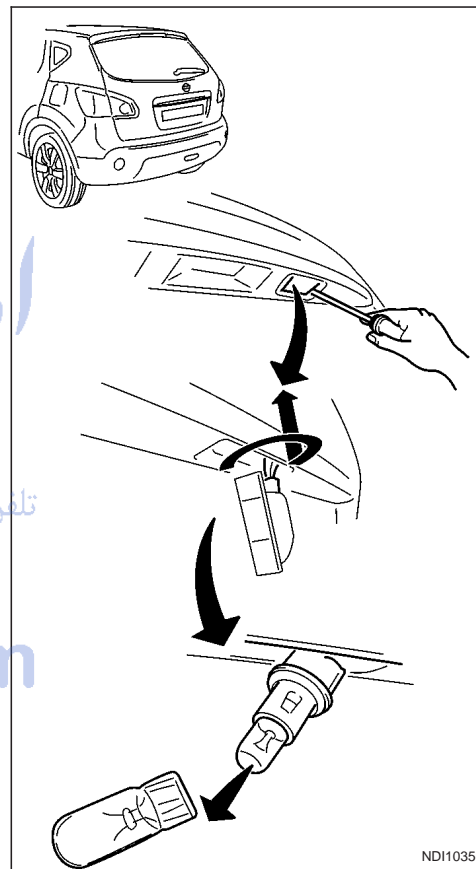

Number plate light

8-30 Maintenance and do-it-yourself



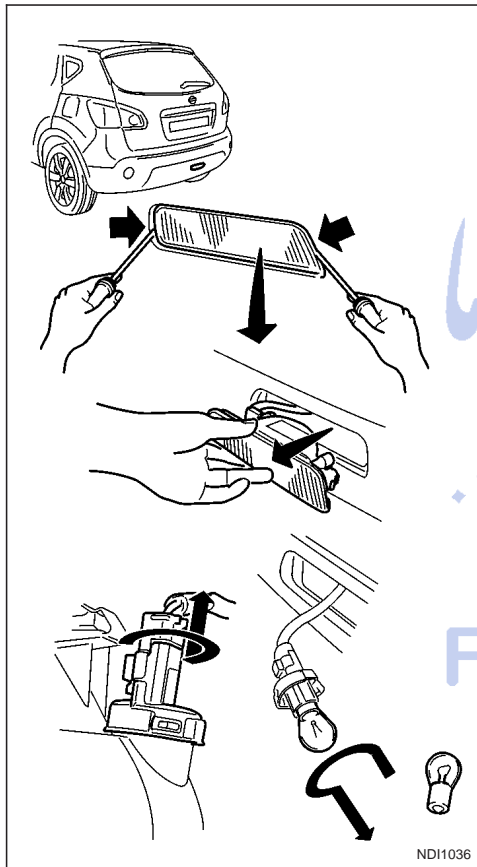

Rear fog light

NDI1036



Rear combination light

NDI1098

(A) Turn signal light

WHEELS AND TYRES

In case of a flat tyre, see "Flat tyre" in the "6. In case of emergency" section.

TYRE INFLATION PRESSURE

Periodically check the tyre pressure (including the spare tyre). An incorrect tyre pressure may adversely affect tyre life and vehicle handling.

NOTE

Incorrectly inflated tyres can also lead to poor steering ability and make the driver suspect a steering problem: keep the vehicle's tyres inflated to the correct pressure at all times.

The tyre pressure should be checked when tyres are COLD. Tyres are considered COLD after the vehicle has been parked for three or more hours, or driven less than 1.6 km (1 mile). COLD tyre pressures are shown on the tyre placard affixed to the driver's side centre pillar.

Insufficient pressure can lead to an overheating of the tyre and subsequent internal damage. At high speeds, this could result in tread separation and even bursting of the tyre.

TYPES OF TYRES

CAUTION

- When changing or replacing tyres, be sure all four tyres are of the same type (i.e., summer, all season or snow) and construction.
- A NISSAN dealer or qualified workshop may be able to help you with information about tyre type, size, speed rating and availability.

- Replacement tyres may have a lower speed rating than the factory equipped tyres, and may not match the potential maximum vehicle speed. Never exceed the maximum speed rating of the tyre.

All season tyres

NISSAN specifies all season tyres on some models to provide good performance for use all year around, including snowy and icy road conditions. All season tyres are identified by ALL SEASON and/or M&S on the tyre sidewall. Snow tyres have better snow traction than all season tyres and may be more appropriate in some areas.

Summer tyres

NISSAN specifies summer tyres as standard fit. These tyres provide superior performance under typical mild weather conditions.

If you plan to operate your vehicle in snowy or icy conditions, NISSAN recommends the use of SNOW or ALL SEASON tyres on all four wheels.

Snow tyres

If snow tyres are needed, it is necessary to select tyres equivalent in size and load rating to the original equipment tyres. If you do not, it can adversely affect the safety and handling of your vehicle.

Generally, snow tyres will have lower speed ratings than factory equipped tyres and may not match the potential maximum vehicle speed. Never exceed the maximum speed rating of the tyre.

For additional traction on icy roads, studded tyres

may be used. However, some provinces and states prohibit their use. Check local, state and provincial laws before installing studded tyres. Skid and traction capabilities of studded snow tyres, on wet or dry surfaces, may be poorer than that of non-studded snow tyres.

SNOW CHAINS

Use of snow chains may be prohibited in some areas. Check the local laws before installing snow chains. When installing snow chains, make sure they are of proper size for the tyres on your vehicle and are installed according to the chain manufacturer's suggestions. Use chain tensioners when recommended by the snow chain manufacturer to ensure a tight fit. Loose end links of the snow chain must be secured or removed to prevent the possibility of whipping action damage to the fenders or undercarriage.

In addition, drive at a reduced speed. Otherwise, your vehicle can be damaged and/or vehicle handling and performance may be adversely affected.

Snow chains must be installed only on the front wheels and not on the rear wheels.

CAUTION

- Never install snow chains on a temporary-use or small size spare tyre.
- Do not drive with snow chains on paved roads which are clear of snow. Driving with chains in such conditions can cause damage to the various mechanisms of the vehicle due to some overstress. When driving on clear paved

roads, be sure to change to 2WD mode, see "Four-wheel Drive (4WD) (where fitted)" in the "5. Starting and driving" section.

TYRE ROTATION

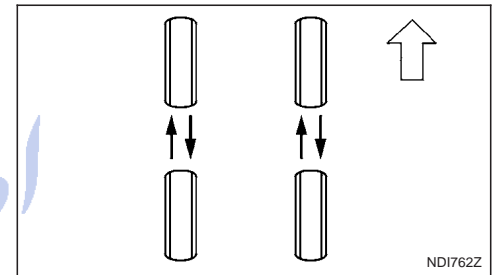

NISSAN recommends that tyres be rotated every 10,000 km (6,000 miles) for Two-Wheel Drive (2WD) vehicles and 5,000 km (3,000 miles) for Four-Wheel Drive (4WD) vehicles.

See "Flat tyre" in the "6. In case of emergency" section for tyre replacing procedures.

WARNING

- After rotating the tyres, adjust the tyre pressure.
- Retighten the wheel nuts when the vehicle has been driven for the first 1,000 km (600 miles) (also in cases of a flat tyre, etc.).
- Do not include the temporary-use spare tyre in the tyre rotation.



- **Incorrect tyre selection, fitting, care or maintenance can affect vehicle safety with risk of accident and injury. If in doubt, consult a NISSAN dealer or the tyre manufacturer.**

TYRE WEAR AND DAMAGE

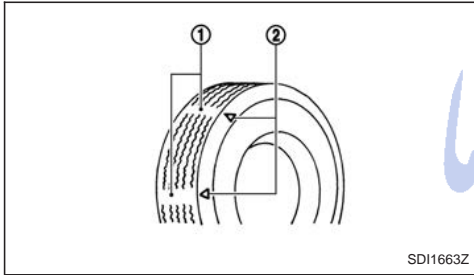

Tyres should be periodically inspected for wear, cracking, bulging or objects caught in the tread. If excessive wear, cracks, bulging or deep cuts are found, the tyre should be replaced.

The original tyres have a built-in tread wear indicator ①. When the wear indicator is visible, the tyre should be replaced.

The wear indicator locations are indicated by the location marks ②.

TYRE AGE

Remember tyre age. Never use a tyre over six years old, regardless of whether they have been used or not.

Tyres degrade with age as well as the use they are subjected to. Have the tyres checked and balanced frequently by a NISSAN dealer or qualified workshop. Report all accidents where the tyre is knocked even if it is minor.

CHANGING TYRES AND WHEELS

WARNING

Do not install a deformed wheel or tyre even if it has been repaired. Such wheels or tyres could have structural damage and could fail without warning.

When replacing a tyre, use the same size, speed rating and load carrying capacity as originally equipped. Recommended types and sizes are mentioned in "Wheels and Tyres" in the "9. Technical information" section.

The use of tyres other than those recommended or the mixed use of tyres of different brands, construction (bias, bias-belted or radial), or tread patterns can adversely affect the ride, braking, handling, ground clearance, body-to-tyre clearance, snow chain clearance, speedometer calibration, headlight aim and bumper height.

WARNING

Some of these effects may lead to accidents and could result in serious personal injury.

If the wheels are changed for any reason, always replace with wheels which have the same offset dimension. Wheels of a different offset could cause

early tyre wear, possibly degraded vehicle handling characteristics and/or interference with the brake discs. Such interference can lead to decreased braking efficiency and/or early brake pad wear.

FOUR-WHEEL DRIVE (4WD) MODELS

CAUTION

- **Always use tyres of the same size, brand, construction (bias, bias-belted or radial), and tread pattern on all four wheels. Failure to do so may result in a circumference difference between tyres on the front and rear axles which will cause excessive tyre wear and may damage the transmission, transfer case and differential gears.**
- **ONLY use spare tyres specified for the four wheel drive (4WD) models.**

WHEEL BALANCE

Unbalanced wheels may affect vehicle handling and tyre life. Even with regular use, wheels can get out of balance. Therefore, they should be balanced as required.

Wheel balance service should be performed with the wheels off the vehicle. Spin balancing the front wheels on the vehicle could lead to transmission damage.

SPARE TYRE

The temporary-use spare wheel/tyre can be identified by the temporary-use spare tyre label which contrasts to the standard road wheels. If in doubt,

contact a NISSAN dealer, qualified workshop or see "Spare tyre" in the "6. In case of emergency" section.

Emergency tyre puncture repair kit (where fitted)

The emergency tyre puncture repair kit is supplied to the vehicle instead of a spare tyre. The repair kit must be used for temporarily fixing a minor tyre puncture. After using the repair kit, see a NISSAN dealer or qualified workshop as soon as possible for tyre inspection and repair/replacement.

CAUTION

Do not use the emergency tyre puncture repair kit under the following conditions. Contact a NISSAN dealer or qualified workshop or professional road assistance.

- when the sealant has passed its expiration date (shown on the label attached to the sealant bottle)
- when the cut or the puncture is approximately 4 mm (0.16 in) or longer
- when the side of the tyre is damaged
- when the vehicle has been driven with a considerable loss of air from the tyre
- when the tyre is completely displaced inside or outside the rim
- when the tyre rim is damaged
- when two or more tyres are flat

See "Spare tyre" in the "6. In case of emergency" section for more details.

CARE OF WHEELS

For details, see "Care of wheels" in the "7. Appearance and care" section.

امداد خودرو فارما

تلفن شبانه روزی: ۰۸۵ + ۸۸۶۲ - ۲۱

FarmaSOS.com



9 Technical information

Capacities and recommended fuel/lubricants	9-2	Vehicle identification plate.....	9-8
Fuel recommendation	9-5	Vehicle identification number (VIN) (chassis	
Recommended SAE viscosity number.....	9-5	number).....	9-8
Air conditioning system refrigerant and		Engine serial number	9-9
lubricant recommendations (where fitted).....	9-6	Tyre placard	9-9
Engine	9-7	Air conditioner specification label (where	
Wheels and Tyres	9-7	fitted) and Automatic transmission fluid label	
Dimensions.....	9-8	(where fitted)	9-10
When travelling or transferring your registration to		NATS immobilizer radio approval number	9-10
another country.....	9-8	Approval numbers.....	9-10
Vehicle identification	9-8		

تلفن شبانه روزی: ۰۲۱-۸۸۶۲۰۸۵

FarmaSOS.com

CAPACITIES AND RECOMMENDED FUEL/LUBRICANTS

The following values are approximate capacities. The actual refill capacities may be slightly different from them. When refilling, follow the procedure instructed in the "8. Maintenance and do-it-yourself" section to determine the proper refill capacity.

		Capacity (approximate)		Recommended specifications
		Litre	Imp measure	
Fuel		65	14-1/4 gal	See "Fuel recommendation" later in this section.
Engine oil (Refill)				
With oil filter replacement	HR16DE	4.3	3-3/4 qt	HR16DE & MR20DE engine: Genuine NISSAN engine oil *1
	MR20DE	4.4	3-7/8 qt	API SL or SM *1 ILSAC grade GF-3 or GF-4 *1
	K9K	4.6 4.4 *8	4 qt 3-7/8 qt *8	ACEA A1/B1, A3/B3, A3/B4, A5/B5, C2 or C3 *1 K9K engine without diesel particulate filter (DPF): Euro 4:
	M9R	7.4	6-1/2 qt	Genuine NISSAN engine oil *1 ACEA A1-B1 *1 *2, SAE 5W30
	R9M	5.5	4-7/8 qt	K9K engine with DPF (where fitted): Genuine NISSAN engine oil *1
	HR16DE	4.1	3-5/8 qt	Euro 4: ACEA A1-B1 *1 *2, SAE 5W30 low SAPS Euro 5: ACEA C4 *1, SAE 5W30 low SAPS
Without oil filter replacement	MR20DE	4.2	3-3/4 qt	M9R engine without DPF: Genuine NISSAN engine oil *1
	K9K	4.4 4.3 *8	3-7/8 qt 3-3/4 qt *8	ACEA B4 *1, SAE 5W40 or 0W40 M9R engine with DPF (where fitted): Genuine NISSAN engine oil *1
	M9R	7.0	6-1/8 qt	ACEA C4 *1 SAE 5W30 low SAPS
	R9M	5.1	4-1/2 qt	R9M engine: Genuine NISSAN engine oil *1 ACEA C4, SAE 5W30 Low SAPS

9-2 Technical information

	Capacity (approximate)		Recommended specifications
	Litre	Imp measure	
Cooling system			
HR16DE (with reservoir)	6.4	5-5/8 qt	
MR20DE (with reservoir)	MT models	7.0	6-1/8 qt
	CVT models	7.4	6-1/2 qt
K9K (with reservoir)	without DPF	7.9	7 qt
	with DPF	9.1	8 qt
M9R (with reservoir)	MT models	8.4	7-3/8 qt
	AT models	8.8	7-3/4 qt
R9M (with reservoir)	8.0	7 qt	
Reservoir	0.8	3/4 qt	
Differential gear oil	0.6	1/2 qt	Genuine NISSAN Differential oil Hypoid Super GL5 80W90 or API GL5. viscosity
Transfer gear oil	0.4	3/8 qt	SAE 80W90
Manual transaxle gear oil			
5MT	2.3	2 qt	
6MT (MR20DE (2WD) or K9K)	2.0	1-3/4 qt	Genuine NISSAN gear oil or API GL4, viscosity SAE 75W80
6MT (MR20DE (4WD), M9R or R9M)	2.0	1-3/4 qt	Genuine NISSAN low viscosity gear oil LV MT-1 75W *7
Automatic Transmission fluid (ATF)	M9R with 4WD	7.5	6-5/8 qt
	HR16 with 2WD	7.1	6-1/4 qt
Continuously Variable Transmission (CVT) fluid	MR20 with 2WD	7.5	6-5/8 qt
	MR20 with 4WD	8.5	7-1/2 qt
	Refill to the proper oil level according to the instructions in the "8. Maintenance and do-it-yourself" section.		
Brake & clutch fluid			Genuine NISSAN brake fluid or equivalent. DOT 4 (US FMVSS No. 116)
Multi-purpose grease	-	-	NLGI No. 2 (Lithium soap base)
Air conditioning system refrigerant	-	-	HFC-134a (R-134a)
Air conditioning system lubricants	-	-	Genuine NISSAN A/C System Oil Type S or exact equivalent

- *1: For further details, see "Recommended SAE viscosity number" later in this section.
- *2: With the technical performances of oil ACEA B3/B4.
- *3: Use Genuine NISSAN engine coolant, or equivalent in its quality, in order to avoid possible aluminium corrosion within the engine cooling system caused by the use of non-genuine engine coolant. **Note that any repairs for the incidents within the engine cooling system while using non-genuine engine coolant may not be covered by the warranty, even if such incidents occurred during the warranty period.** Contact a NISSAN dealer or qualified workshop for more information regarding the coolant type and capacity.
- *4: Using automatic transmission fluid other than Genuine NISSAN Matic Fluid (ATF) type S will cause deterioration in driveability and automatic transmission durability and may damage the automatic transmission, which is not covered by the NISSAN warranty.
- *5: Use only Genuine NISSAN CVT Fluid NS-2. Using CVT fluid other than Genuine NISSAN CVT Fluid (NS-2) will damage the CVT transmission system, which is not covered by the NISSAN warranty.
- *6: Contact a NISSAN dealer or qualified workshop for servicing.
- *7: If Genuine NISSAN low viscosity gear oil LV MT-1 75W is not available, Genuine NISSAN gear oil HQ Multi 75W-85 or gear oil meeting SAE 75W-85 API GL4 specifications may be used.
- *8: For K9K Euro 5 models

تلفن شبانه روزی: ۰۲۱-۸۸۸۶۲۰۸۵

FarmaSOS.com

9-4 Technical information



FUEL RECOMMENDATION

Petrol engine

Unleaded petrol with an octane rating of at least 95 (RON) must be used.

CAUTION

Do not use leaded petrol. Using leaded petrol will damage the catalytic converter.

Diesel engine

EN590 Diesel fuel of at least 51 cetane must be used.

NOTE

Use only low sulphur diesel.

If two types of diesel fuel are available, use summer or winter fuel properly according to the following temperature conditions.

- Above -7°C (20°F) . . . Summer type diesel fuel.
- Below -7°C (20°F) . . . Winter type diesel fuel.

If you are in any doubt, please consult a NISSAN dealer or qualified workshop.

CAUTION

- Do not use home heating oil, petrol or other alternate fuels in the diesel engine, this can cause engine damage.
- Do not add petrol or other alternate fuels to diesel fuel.

- Do not use summer fuel at temperatures below -7°C (20°F). The cold temperatures will cause wax to form in the fuel. As a result, it may prevent the engine from running smoothly.

RECOMMENDED SAE VISCOSITY NUMBER

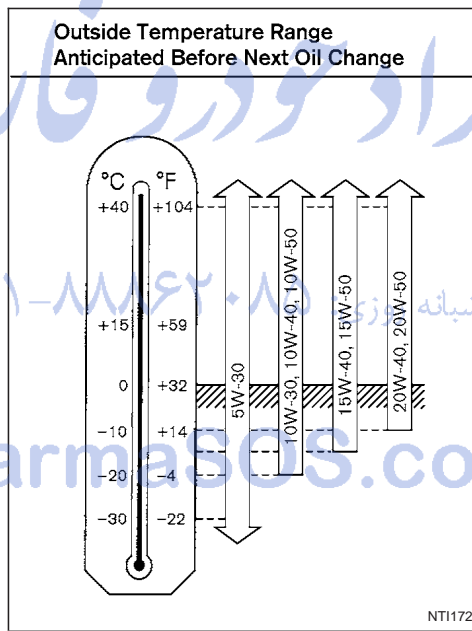

Engine oil (Petrol or K9K without diesel particulate filter (DPF))

Petrol engine oil

5W-30 is preferable. If 5W-30 is not available, select the viscosity from the chart, that is suitable for the outside temperature range.

Diesel engine oil

- K9K engine without DPF:

5W-30 is preferable. If 5W-30 is not available, select the viscosity from the chart, that is suitable for the outside temperature range.

- M9R engine without DPF:

ONLY use 5W40 or 0W40

- K9K and M9R engine with DPF (where fitted) or R9M engine:

ONLY use 5W30 low SAPS

Manual gear oil

- For manual transmission:

75W80 or 75W85 (depending on the manual transmission type) is preferable.

- For transfer and rear differential:

- 80W90 is preferable.
- For hot areas: 90 is suitable for ambient temperatures below 40°C .
- For very hot areas: 140 for the differential gear.

AIR CONDITIONING SYSTEM REFRIGERANT AND LUBRICANT RECOMMENDATIONS (where fitted)

The air conditioning system in this NISSAN vehicle must be charged with the HFC-134a (R-134a) refrigerant and the Genuine NISSAN A/C System Oil Type S or the exact equivalents.

Use of any other refrigerants or lubricants will cause severe damage and will lead to the vehicle's entire air conditioning system replacement.

NISSAN GREEN PROGRAM

The release of refrigerant into the atmosphere is not recommended. The new refrigerant HFC-134a (R-134a) in your NISSAN vehicle will not harm the earth's ozone layer. However it may contribute in a small part to global warming. NISSAN recommends that the refrigerant be recovered and recycled.

Contact a NISSAN dealer or qualified workshop when servicing the air conditioning system.

امداد خودرو فارما

تلفن شبانه روزی: ۰۸۵-۸۸۶۲۰۲۱

FarmaSOS.com



ENGINE

Model	HR16DE	MR20DE	K9K	M9R	R9M
Type	Petrol, 4-cycle	Petrol, 4-cycle	Diesel, 4-cycle	Diesel, 4-cycle	Diesel, 4-cycle
Cylinder arrangement	4-cylinder in-line	4-cylinder in-line	4-cylinder in-line	4-cylinder in-line	4-cylinder in-line
Bore x Stroke	78.0 x 83.6 (3.071 x 3.291)	84 x 90.1 (3.31 x 3.55)	76.0 x 80.5 (2.992 x 3.169)	84 x 90 (3.31 x 3.54)	80 x 79.5 (3.15 x 3.13)
Displacement	1,598 (97.51)	1,997 (121.86)	1,461 (89.15)	1,995 (121.73)	1,598 (97.51)
Firing order	1-3-4-2	1-3-4-2	1-3-4-2	1-3-4-2	1-3-4-2
Idling speed	rpm				
MT	650 ± 50		800 ± 50		
AT or CVT in N position	—	700 ± 50	—	750 ± 50	—
Ignition timing (BTDC)	degree				
MT	15 ± 5°		—	—	—
CVT in N position	—	15 ± 5°	—	—	—
Spark plug	Standard PLZKAR6A-11	PLZKAR6A-11	—	—	—
Spark plug gap	mm (in) 1.1 (0.043)	1.1 (0.043)	—	—	—
Camshaft operation	Timing chain	Timing chain	Timing belt	Timing chain	Timing chain

WHEELS AND TYRES

Unit: mm (in)		
Item	Size	Offset
Road wheel	Steel	16 x 6.5J
		16 x 4T *1
		17 x 4T *1
	Aluminium*	16 x 6.5J
		40 (1.57)
		17 x 6.5J
		18 x 6.5J
Tyre size	Conventional	215/65R16
		215/60R17*
		215/55R18*
Spare	5-seater	Conventional *
	7-seater	T145/90R16 *1
		T155/70R17 *1

* : where fitted

*1: Temporary-use spare tyre (where fitted)

DIMENSIONS

Unit: mm (in)

	5-seater	7-seater
Overall length	4,332 (170.6)	4,542 (178.8)
Overall width	1,780 (70.1)	1,780 (70.1)
Overall height	1,605 (63.2)	1,645 (64.8)
	1,622 (63.9)*	
Front tread	1,540 (60.6)	1,540 (60.6)
Rear tread	1,545 (60.8)	1,550 (61)
Wheelbase	2,630 (103.5)	2,765 (108.9)

* : with roof rail

WHEN TRAVELLING OR TRANSFERRING YOUR REGISTRATION TO ANOTHER COUNTRY

When planning to travel in another country, you should first find out if the fuel available is suitable for your vehicle's engine.

Using fuel with too low octane/cetane rating may cause engine damage. Therefore, avoid taking your vehicle to areas where appropriate fuel is not available.

When transferring your vehicle registration to another country, check with the appropriate authorities that the vehicle complies with the requirements as it may not be possible to adapt it. In some cases, a vehicle cannot meet the legal requirements and in other cases, it may be necessary to modify the vehicle to meet specific laws and regulations.

The laws and regulations for motor vehicle emission control and safety standards vary according to the country; therefore, vehicle specifications may differ.

NISSAN is not responsible for any inconvenience when the vehicle is taken and registered into another country. The necessary modifications, transportation and registration are the owner's responsibility.

VEHICLE IDENTIFICATION

VEHICLE IDENTIFICATION PLATE

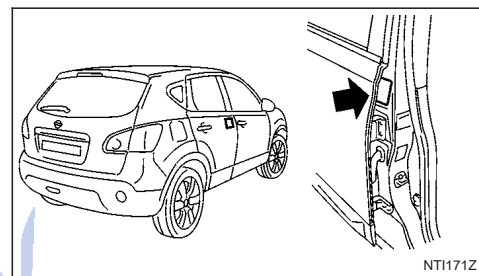

NT1171Z

The plate is affixed as shown.

VEHICLE IDENTIFICATION NUMBER (VIN) (chassis number)

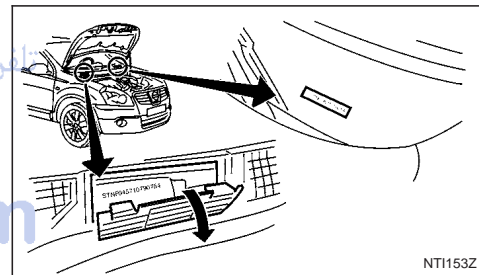

NT1153Z

The number is stamped as shown.

9-8 Technical information

ENGINE SERIAL NUMBER

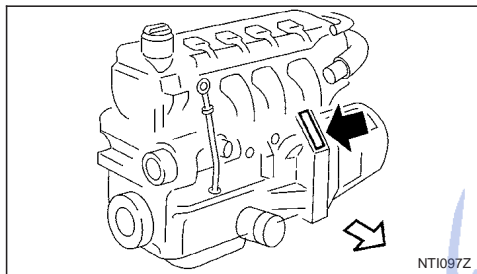

HR16DE or MR20DE engine

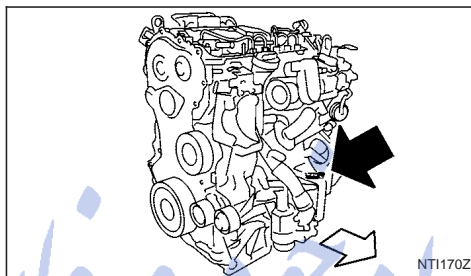

M9R engine

TYRE PLACARD

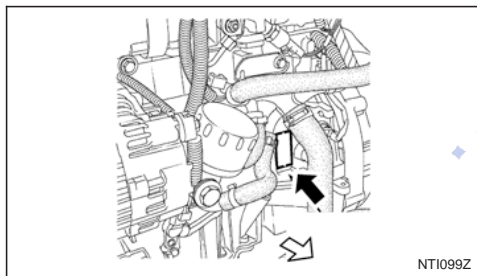
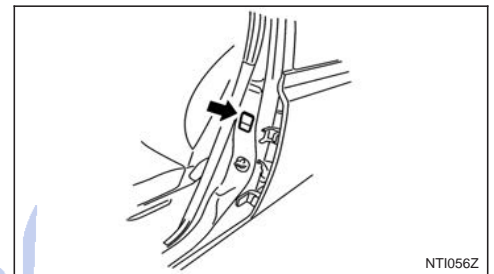

K9K engine

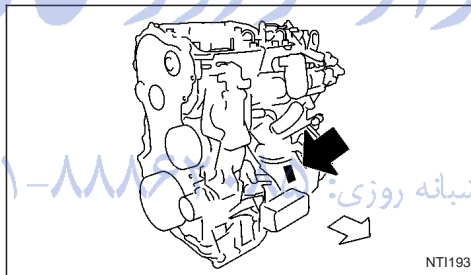

R9M engine

The cold tyre pressure is shown on the tyre placard fixed to the side of the driver's side centre pillar. Note that this illustration is for LHD models.

The number is stamped on the engine as shown.

FarmasOS.com

NATS IMMOBILIZER RADIO APPROVAL NUMBER

APPROVAL NUMBERS

AIR CONDITIONER SPECIFICATION LABEL (where fitted) and AUTOMATIC TRANSMISSION FLUID LABEL (where fitted)

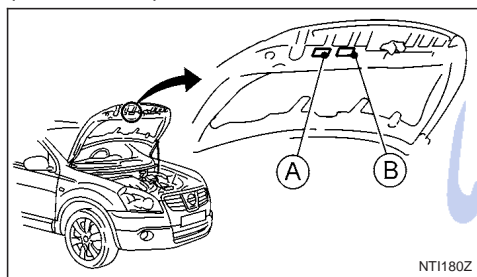

- Ⓐ Automatic transmission label
- Ⓑ Air conditioner specification label

The label is affixed as shown.



Your vehicle is equipped with the NISSAN step 8 immobilizer system and the approval number is e24*74/61*95/56*0103*00.

All radio frequency or audio frequency products fitted to the NISSAN range during production conform to the requirements of the R&TTE Directive.

- Integrated keyfob: 5WK4 8763
- Intelligent Key (where fitted):
 - e11*74/61*95/56*2014*2
 - Manufacturer name: ALPS ELECTRIC CO., LTD
 - Model name: TFWD1G63, TFWB1G614
 - Made in U.K.
- Alarm (Siren) system (where fitted):
 - e24-116RA-000002 and
 - e24*72/245*2006/28*1212*00

تلفن شبانه روزی: ۰۲۱-۸۸۸۶۲۰۸۵

FarmaSOS.com

NOTE

امداد خودرو فارما

تلفن شبانه روزی: ۰۸۵-۸۸۸۶۲۰۲۱

FarmaSOS.com

Technical information 9-11



NOTE

امداد خودرو فارما

تلفن شبانه روزی: ۰۸۵-۸۸۸۶۲۰۲۱

FarmaSOS.com

9-12 Technical information



NOTE

امداد خودرو فارما

تلفن شبانه روزی: ۰۸۵-۸۸۸۶۲۰۲۱

FarmaSOS.com

Technical information 9-13



NOTE

امداد خودرو فارما

تلفن شبانه روزی: ۰۸۵-۸۸۸۶۲۰۲۱

FarmaSOS.com

9-14 Technical information



NOTE

امداد خودرو فارما

تلفن شبانه روزی: ۰۸۵-۸۸۸۶۲۰۲۱

FarmaSOS.com

Technical information 9-15

NOTE

امداد خودرو فارما

تلفن شبانه روزی: ۰۲۱-۸۸۸۶۲۰۸۵

FarmaSOS.com

9-16 Technical information



10 Index

A	
Air bag system (Supplemental Restraint System)	1-14
Air bag warning labels	1-16
Air bag warning light	1-16
Air cleaner filter	8-21
Air conditioner	
– Air conditioner filter	4-17, 4-21
– Air conditioning system refrigerant and lubricant recommendations	9-6
– Automatic air conditioner	4-18
– Heater and air conditioner	4-12
– Manual air conditioner	4-13
– Servicing air conditioner	4-17, 4-21
Alarm system	3-13
Anchor points	
– Child restraints	1-28
Antenna	4-22
Anti-hijack – unlock mode	3-4
Anti-lock Braking System (ABS)	5-39
Anti-Theft System (NISSAN)	3-13
Approval numbers	9-10
Armrest	1-5
Around view monitor	4-4
Around view monitor operation	4-6
Audible reminders, warning/indicator lights	2-3
Audio	
– Anti-theft system	4-24, 4-31
– Audio operation precautions	4-21
– Audio system	4-21
– AUX socket	4-29, 4-36

– Bluetooth® audio streaming main operation	4-40
– FM AM radio with CD player	4-30
– iPod® player operation	4-37
– LW-MW-FM radio with 6 CD changer	4-23
– LW-MW-FM radio with CD player	4-23
– NISSAN Connect	4-43
– Steering-wheel switch for audio control	4-43
– USB Memory operation	4-37
Automatic transmission	
– Automatic transmission fluid (ATF)	8-14
– Automatic transmission fluid label	9-10
– Driving with automatic transmission	5-14

B	
Battery	5-43, 8-17
– Caution label	8-17
– Integrated keyfob battery replacement	8-19
– Intelligent Key battery replacement	8-19
– Vehicle battery	8-17
Before starting the engine	5-2
Bluetooth®	4-44
– Bluetooth® mobile phone feature	4-52
– Bluetooth® operation	4-39
– Bluetooth® settings	4-39
Bonnet release	3-14
Brake	8-15
– Anti-lock Braking System (ABS)	5-39
– Brake fluid	8-15
– Brake precautions	5-39
– Brake system	5-39
– Checking brake pedal	8-15

Farmasoft.com

تلفن شبانه روزی: ۰۲۱-۸۸۸۹۰۰۸۵



- Checking handbrake 8-15
- Handbrake lever 3-16
- Trailer brakes 5-36
- Brightness control 2-16

C

- C-View® 2-36
- Sunshade (Reinitialisation procedure) 2-37
- Sunshade operation 2-36
- Capacities and recommended fuel/lubricants 9-2
- Fuel recommendation 9-5
- Car phone or CB radio 4-44
- Care when driving 5-6
- Changing
 - Changing engine coolant 8-6
 - Changing engine oil 8-9
 - Changing engine oil filter 8-11
 - Changing tyres and wheels 8-33
- Checking
 - Checking brake pedal 8-15
 - Checking engine coolant level 8-6
 - Checking engine oil level 8-8
 - Checking handbrake 8-15
- Child restraints 1-18
- 5-seater 1-20
- 7-seater 1-20
- Anchor points 1-28
- Installation on front passenger seat 1-23
- Installation on rear seats 1-24
- Top tether strap for child restraint 1-27
- Child safety 1-8
- Cleaning
 - Alloy wheels 7-3
 - Chrome parts 7-3
 - Exterior 7-2

- Glass 7-3, 7-4
- Interior 7-4
- Plastic parts 7-4
- Rear-view camera lens 7-3
- Removing spots 7-2
- Underbody 7-3
- Clutch fluid 8-15
- Cold weather driving 5-42
- Console box 2-32
- Continuously variable transmission
 - Continuously variable transmission fluid 8-14
 - Driving with continuously variable transmission (Models with manual shift) 5-14
 - Driving with continuously variable transmission (Models without manual shift) 5-17
- Coolant
 - Changing engine coolant 8-6
 - Checking engine coolant level 8-6
 - Engine coolant 5-43
 - Engine coolant temperature gauge 2-2
 - Engine cooling system 8-6
- Corrosion protection 5-43, 7-5
- Environmental factors 7-5
- Cruise control 2-21, 5-29
- Cruise control system operations 5-30

D

- Defogger switch
 - Outside mirror defogger 2-24
 - Rear window defogger 2-23
- Diesel particulate filter (DPF) 5-5
- Diesel particulate filter (DPF) warning light 2-4
- Difference between predictive and actual distances 4-9
- Dimensions 9-8



Display	
- Vehicle information display	2-11
Door locks	3-9
- Back door	3-12
- Child safety rear door locks	3-11
- Drive away door locking	3-11
- Locking/unlocking with the key — vehicle dead battery	3-9
- Power door lock switch	3-10
- Remote keyless entry system	3-3
- Super Lock system	3-9
- When leaving the vehicle	3-10
Drive belts	8-21
Driving	
- Care when driving	5-6
- Cold weather driving	5-42
- Driving four-wheel drive (4WD) safely	5-27
- Driving on wet road	5-6
- Driving the vehicle	5-12
- Driving under winter conditions	5-6
- Driving with automatic transmission	5-14, 5-17
- Driving with continuously variable transmission (Models with manual shift)	5-14
- Driving with continuously variable transmission (Models without manual shift)	5-17
- Driving with manual transmission	5-12
- On-pavement and off-road driving precautions	5-4
- Precautions when starting and driving	5-3
- Stop/Start System	5-21

E

Electronic Stability Programme (ESP) system	5-40
- ESP OFF switch	5-42
Emergency tyre puncture repair kit	6-7, 8-34
Emergency/mechanical key	3-3

Engine	
- Before starting the engine	5-2
- Changing engine coolant	8-6
- Changing engine oil	8-9
- Changing engine oil filter	8-11
- Checking engine coolant level	8-6
- Checking engine oil level	8-8
- Data	9-7
- Engine cold start period	5-6
- Engine compartment	0-7, 8-5
- Engine coolant	5-43
- Engine coolant temperature gauge	2-2
- Engine cooling system	8-6
- Engine oil	8-8
- Engine overheat	6-12
- Engine serial number	9-9
- Fuel filter (Diesel engine models)	8-13
- Starting the engine	5-11
Exhaust gas (Carbon Monoxide)	5-3
Exterior lights	8-27

F

Filter	
- Air cleaner filter	8-21
- Air conditioner filter	4-17, 4-21
- Fuel filter (Diesel engine models)	8-13
Floor mats	7-4
Fluid	
- Automatic transmission fluid (ATF)	8-14
- Brake and clutch fluid	8-15
- Continuously variable transmission fluid	8-14
- Window washer/headlight cleaner fluid	8-16
Fog light	
- Front fog light	2-26
- Rear fog light	2-27

Four-wheel drive (4WD)	5-24
- Driving four-wheel drive (4WD) safely	5-27
- Four-wheel drive (4WD) model (Tyres)	8-33
- Four-wheel drive mode indicator light	5-27
- Four-wheel drive warning light	5-26
Front passenger air bag deactivation system	1-17
Front passenger air bag indicator light	1-17
Fuel	
- Bleeding the fuel system	8-14
- Capacities and recommended fuel/lubricants	9-2
- Draining water (Fuel filter)	8-13
- Fuel filter (Diesel engine models)	8-13
- Fuel gauge	2-2
- Fuel recommendation	9-5
Fuel filler lid	
- Cap	3-15
- Opener lever	3-15
Fuses	8-23
- Engine compartment	8-24
- Passenger compartment	8-23

G

Gauges	
- Engine coolant temperature gauge	2-2
- Fuel gauge	2-2
- Meters and gauges	2-2
Glove box	2-31
Guide lines	4-7

H

Handbrake lever	3-16
Hazard warning flasher switch	2-28

Head restraint	
- Active head restraints	1-6
- Adjustment	1-5
Headlight	
- Headlight aiming control switch	2-27
- Headlight and turn signal switch	2-24
- Headlight cleaner	2-28
- Headlight switch	2-24
- Headlights (bulb replacement)	8-26
- Replacement (bulb)	8-25
- Turn signal switch	2-26
- Xenon	2-24
Heated seats	2-29
Heater and air conditioner	4-12
Horn	2-29
How to adjust the screen view	4-11

I

Ignition	
- Ignition knob (Intelligent Key equipped models)	5-8
- Ignition switch	5-6
Immobilizer	
- NATS immobilizer radio approval number	9-10
- NISSAN Anti-Theft System (NATS)	3-13
Indicator lights	2-3
Injured persons	1-9
Inside rear-view mirror	3-17
Instrument and control layout	
- LHD and RHD models	0-5
Integrated keyfob (remote control system)	3-3
- Battery replacement	8-19
- Ignition switch	5-6
- Keyfob operation failure	3-6
- Locking the doors	3-5
- Setting the unlock mode	3-4



- Super Lock system	3-5
- Unlocking the doors	3-5
Intelligent Key operating range	3-6
Intelligent Key system	3-6
- Anti-hijack mode	3-7
- Battery replacement	8-19
- Emergency key – Intelligent Key dead battery situation ...	5-10
- Ignition knob	5-8
- Locking/unlocking	3-7
- Starting the engine	3-8
Interior lights	2-37, 8-27
iPod® player operation	4-37
ISOFIX system	1-26

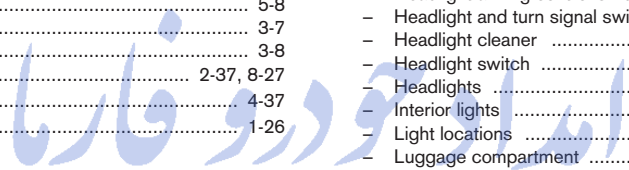

J

Jump-starting	6-10, 8-19
---------------------	------------

K

Key	3-2
- Ignition knob positions	5-9
- Immobilizer	3-2
- Integrated keyfob (remote control system)	3-3
- Intelligent Key operating range	3-6
- Intelligent Key system	3-6
- Key positions (Ignition switch)	5-7
- NISSAN Anti-Theft System (NATS)	3-2
- NISSAN Anti-Theft System (NATS) key	3-2
- Remote keyless entry system	3-3
- Using Intelligent Key system	3-7

L

Light	
- Exterior lights	8-27
- Fog light switch	2-26
- Hazard warning flasher switch	2-28
- Headlight aiming control switch	2-27
- Headlight and turn signal switch	2-24
- Headlight cleaner	2-28
- Headlight switch	2-24
- Headlights	8-25
- Interior lights	2-37, 8-27
- Light locations	8-27
- Luggage compartment	2-38
- Map lights	2-38
- Rear room/reading light	2-38
- Room light	2-37
- Trailer direction indicator light	5-36
- Turn signal switch	2-26
- Warning/indicator lights and audible reminders	2-3
- Xenon headlight	2-24, 8-25
Lock	
- Back door lock	3-12
- Child safety rear door locks	3-11
- Door locks	3-9
- Drive away door locking	3-11
- Power door lock switch	3-10
- Steering lock	5-7, 5-9
- Super Lock system	3-9
- Unlocking with inside door handle	3-10

M

Maintenance	
- General maintenance	8-2
- Maintenance precautions	8-4

- Maintenance requirements	8-2
- Seat belt maintenance	1-11
Manual transmission	
- Driving with manual transmission	5-12
Mechanical/emergency key	3-3
Meter and gauges	
- Engine coolant temperature gauge	2-2
- Fuel gauge	2-2
- Speedometer	2-2
- Tachometer	2-2
Meters and gauges	2-2
Mirror	3-17
- Automatic anti-dazzling inside mirror	3-17, 7-4
- Inside rear-view mirror	3-17
- Outside rear-view mirrors	3-17
- Vanity mirror	3-19
Mobile phone integration for FM AM radio with CD player ...	4-52
Mobile phone integration for LW-MW-FM radio with CD player or 6 CD changer (Type A)	4-44
Monitor display	
- Monitor display's maintenance	7-4
- Rear-view monitor	4-2

N

NISSAN Anti-Theft System (NATS)	3-2, 5-10, 5-7
- NATS immobilizer radio approval number	9-10
- NATS key	3-2
- NATS security indicator light	3-13

O

Oil	
- Changing engine oil	8-9
- Changing engine oil filter	8-11

- Checking engine oil level	8-8
- Engine oil	8-8
- Recommended lubricants	9-2
- Recommended SAE viscosity number	9-5
On-pavement and off-road driving precautions	5-4
Overheat	
- Engine overheat	6-12

P

Parking	5-33
- Ultrasonic parking sensor	5-24
Phone	
- Bluetooth®	4-44, 4-52
- Mobile phone integration for FM AM radio with CD player	4-52
- Mobile phone integration for LW-MW-FM radio with CD player or 6 CD changer (Type A)	4-44
Power	
- Power door lock switch	3-10
- Power outlet	2-30
- Power steering system	5-38
- Power window — Driver's side (Reinitialisation procedure)	2-35
- Power windows	2-34
Pre-tensioner seat belt system	1-12
Precautions	
- Audio operation precautions	4-21
- Brake precautions	5-39
- Child restraint usage	1-18
- Cruise control precautions	5-29
- Maintenance precautions	8-4
- On-pavement and off-road driving precautions	5-4
- Operating precautions (trailer)	5-35
- Seat belt usage	1-7
- Towing precautions	6-13

- When starting and driving	5-3
Pregnant women	1-8
Protect	
- Protect the environment	8-13
- Protect your vehicle from corrosion	7-5
Push-starting	6-12

R

Radio	
- FM AM radio with CD player	4-30
- LW-MW-FM radio with 6 CD changer	4-23
- LW-MW-FM radio with CD player	4-23
- NATS immobilizer radio approval number	9-10
- NISSAN Connect	4-43
Rear parcel shelf	2-33
- Installation	2-33
- Removal	2-33
Rear seat	1-3
Rear window defogger	2-23
Rear-view monitor	4-2
- Operating tips	4-3
- Rear-view monitor setting	4-3
Recommended SAE viscosity number	9-5
Remote control system (integrated keyfob)	3-3
Repairing flat tyre	6-7
Roof rail	2-32
Running-in schedule	5-2

S

Safety	
- Active head restraints	1-6
- Child safety	1-8
- Child safety rear door locks	3-11

- Head restraints adjustment	1-5
- ISOFIX system	1-26
- Safety chains (Trailer)	5-36
- Top tether strap for child restraint	1-27
Seat	
- Active head restraints	1-6
- Armrest	1-5
- Front seats – Adjustment	1-2
- Head restraints adjustment	1-5
- Rear seat	1-3
- Seat heating	2-29
- Seats	1-2
Seat belt	
- Child safety	1-8
- Injured persons	1-9
- Pre-tensioner seat belt system	1-12
- Precautions on seat belt usage	1-7
- Pregnant women	1-8
- Rear centre seat	1-9
- Seat belt maintenance	1-11
- Seat belt warning	1-6
- Seat belt warning (Rear seat or 2nd row)	2-12
- Seat belt warning light	2-3
- Seat belts	1-6, 7-4
- Three-point type seat belts	1-9
Security system	3-13
- Alarm system	3-13
- NISSAN Anti-Theft System (NATS)	3-13, 3-2
Servicing air conditioner	4-17, 4-21
Snow chains	8-32
Spare tyre	6-2
Spark plugs (Petrol engine models)	8-21
Speed limiter	2-21, 5-31
Speed limiter operations	5-32
Speedometer	2-2
Starting	
- Before starting the engine	5-2

- Jump-starting	6-10, 8-19
- Precautions when starting and driving	5-3
- Push-starting	6-12
- Starting the engine	5-11
Steering	
- Power steering system	5-38
- Steering lock	5-7, 5-9
- Steering wheel adjustment	3-16
- Steering wheel switches for hands-free telephone control	4-55
- Steering-wheel switch for audio control	4-43
- Steering-wheel switch for hands-free telephone control	4-50
- Telephone button	4-44, 4-52, 4-55
Stop/Start System	5-21
Storage	
- Bottle holder	2-32
- Console box	2-32
- Cup holder	2-32
- Glove box	2-31
- Map pockets	2-32
- Roof rail	2-32
- Seat pockets	2-32
- Storage trays	2-31
- Sunglasses holder	2-32
Sun visors	3-17
Sunshade	
- Sunshade (Reinitialisation procedure)	2-37
- Sunshade operation	2-36
Super Lock system	
- Emergency situations	3-9
- Power door lock switch	3-11
Supplemental Restraint System (air bag system)	
- Air bag system	1-13
- Air bag warning labels	1-16
- Air bag warning light	1-16
- Front passenger air bag deactivate switch	1-17
- Front passenger air bag indicator light	1-17

Switch	
- Defogger switch	2-23
- Fog light switch	2-26
- Headlight and turn signal switch	2-24
- Headlight cleaner switch	2-28
- Power door lock switch	3-10
- Wiper and washer switch	2-21

T

Tachometer	2-2
Temporary-use spare tyre	6-2
Three-point type seat belts	1-9
Three-way catalyst (Petrol engine models)	5-4
Tilting steering wheel	3-16
Tonneau cover	2-33
Towing	
- Recommended towing for four-wheel drive (4WD) models	6-14
- Recommended towing for two-wheel drive (2WD) models	6-14
- Tow bar Installation	5-36
- Tow truck towing	6-13
- Towing eye	6-15
- Towing precautions	6-13
- Trailer towing	5-35
Trailer	
- Trailer brakes	5-36
- Trailer detection	5-36
- Trailer direction indicator light	2-9
- Trailer towing	5-35
Transmission	
- Automatic transmission (ignition knob)	5-7, 5-9
- Automatic transmission fluid (ATF)	8-14
- Continuously variable transmission (ignition knob)	5-7, 5-9
- Continuously variable transmission fluid	8-14

- Driving with automatic transmission	5-14, 5-17
- Driving with continuously variable transmission (Models with manual shift)	5-14
- Driving with continuously variable transmission (Models without manual shift)	5-17
- Driving with manual transmission	5-12
- Manual transmission (ignition knob)	5-8
- Manual transmission (ignition switch)	5-6
Travelling or transferring your registration to another country ..	9-8
Trip computer	2-16
Turbocharger system (Diesel engine models)	5-5
Turn signal switch	2-26
Twin trip odometer	2-16
Tyre	
- Changing tyres and wheels	8-33
- Emergency tyre puncture repair kit	6-7, 8-34
- Flat tyre	6-2
- Repairing flat tyre	6-7
- Spare tyre	8-33
- Temporary-use spare tyre	6-2
- Types of tyres	8-31
- Tyre age	8-33
- Tyre equipment	5-43
- Tyre inflation pressure	8-31
- Tyre placard	9-9
- Tyre pressure (Trailer)	5-36
- Tyre rotation	8-32
- Tyre wear and damage	8-33
- Wheels and tyres	8-31, 9-7

U

Ultrasonic sensor	
- Alarm sensor	3-13
- Parking sensor	5-24
USB Memory operation	4-37

Using Intelligent Key system	3-7
------------------------------------	-----

V

Vehicle identification		9-8
- Vehicle identification number (VIN) (chassis number)		9-8
- Vehicle identification plate		9-8
Vehicle information display		2-11
Vehicle security		3-13, 5-38
- Alarm system		3-13
Vents		4-12

W

Warning/indicator lights and audible reminders	2-3
Warnings and alerts (Vehicle information display)	2-12
Washing	7-2
Waxing	7-2
Wheel	
- Blocking the wheels	6-3
- Care of wheels	7-3
- Changing tyres and wheels	8-33
- Getting the tools and spare wheel	6-3
- Installing the wheel	6-6
- Removing the wheel	6-4
- Removing the wheel cover	6-4
- Stowing the wheel and tools	6-6
- Wheel balance	8-33
- Wheel lock key code	6-7
- Wheel lock nuts	6-4, 6-7
- Wheels and tyres	8-31, 9-7
Wheel lock nuts	6-7
Windows	
- Power window — Driver's side (Reinitialisation procedure)	2-35

- Power windows	2-34
Winter (Special winter equipment)	5-43
Wiper	
- Back door window wiper replacement	8-23
- Front window wiper replacement	8-22
- Rain sensor	2-22
- Rear window wiper and washer switch	2-23
- Washer nozzle	8-23
- Window washer/headlight cleaner fluid	8-16
- Windscreen wiper and washer switch	2-22
- Wiper blades replacement	8-22

امداد خودرو فارما

تلفن شبانه روزی: ۰۲۱-۸۸۸۶۲۰۸۵

FarmaSOS.com



PETROL STATION INFORMATION

RECOMMENDED FUEL

Petrol engine

CAUTION

Do not use leaded petrol. Using leaded petrol will damage the three-way catalyst.

Unleaded petrol with an octane rating of at least 95 (RON) must be used.

For further details, see "Fuel recommendation" in the "9. Technical information" section.

Diesel engine

EN590 Diesel fuel of at least 51 cetane must be used.

NOTE

Use only low sulphur diesel.

For further details, see "Fuel recommendation" in the "9. Technical information" section.

CAUTION

- Do not use home heating oil, petrol or other alternate fuels in the diesel engine, this can cause engine damage.
- Do not add petrol or other alternate fuels to diesel fuel.
- Do not use summer fuel at temperatures below -7°C (20°F). Cold temperatures will cause wax to form in the fuel and may prevent the engine from running smoothly.

RECOMMENDED ENGINE OIL *

HR16DE or MR20DE engine

- Genuine NISSAN engine oil
- API grade: SL or SM
- ILSAC grade: GF-3 or GF-4
- ACEA A1/B1, A3/B3, A3/B4 or A5/B5, C2 or C3

K9K engine

- Genuine NISSAN engine oil
- K9K engine without diesel particulate filter Euro 4:
Genuine NISSAN engine oil
ACEA A1-B1 (with the technical performances of oil ACEA B3/B4)
- K9K engine with diesel particulate filter (where fitted):
Genuine NISSAN engine oil
Euro 4: ACEA A1-B1 (with the technical performances of oil ACEA B3/B4) Low SAPS
Euro 5: ACEA C4, Low SAPS

M9R engine

- Genuine NISSAN engine oil
- without diesel particulate filter: ACEA B4
- with diesel particulate filter: ACEA C4

R9M engine

- Genuine NISSAN engine oil
- ACEA C4 Low SAPS

* For further details, see "Capacities and recommended fuel/lubricants" in the "9. Technical information" section.

COLD TYRE PRESSURE

See the tyre placard affixed to the driver's side centre pillar.

امداد خودرو فارس
تلفن شبک روری ۰۲۱-۸۸۴۲۱۱۱۱
FarmaSOS.com

ENVIRONMENT (End of Life Vehicles)

ENVIRONMENTAL CONCERN



NISSAN GREEN PROGRAM

Today, the efforts made by NISSAN to fulfil our responsibilities to protect and sustain the environment are far-reaching. Within NISSAN, we promote the highest levels of practice in every region and in every area of operations.

COMPLIANCE AT EVERY STEP

NISSAN focuses on ensuring that end of life vehicle components are reused, recycled or recovered as thermal energy, and guarantees compliance with EU legislation (the End of Life Vehicle Directive).

WE BUILD OUR VEHICLES WITH RECYCLING IN MIND

Reducing landfill waste, emissions, conserving natural resources, and enhancing recycling activities are emphasised daily in our manufacturing, sales and service operations and in the disposal of end of life vehicles (ELV).

Design phase

To reduce environmental impact we have developed your NISSAN vehicle to be 95% recyclable. We mark the components to facilitate dismantling, recycling and to reduce hazardous substances. We carefully verify and control substances of concern. We have already reduced to a minimum the cadmium, mercury and lead in your NISSAN vehicle. NISSAN includes recycled material in your vehicle and looks for opportunities to increase the percentage of recycled materials used.

Manufacturing phase

NISSAN plants based in the UK and Spain already achieve a recycling rate of over 90% and are looking for further improvements. The UK plant installed 8 windmills to cut carbon dioxide emissions at power plants by more than 3,000 tonnes per year. Since the end of March 2007, NMISA (Spain) uses a solar panel water heating system to save energy. This will generate 33% of the energy consumed in the baths during the painting of your vehicle.

Production and distribution phase

Using resources efficiently to reduce the amount of waste generated during the production and distribution stage. NISSAN promotes activities based on Reducing, Reusing, and Recycling materials whenever possible. The NISSAN GREEN PROGRAM 2010 (NGP2010) is our midterm environmental action plan defining our goals for achieving a 100% recycling rate for operations in Japan and globally.

Use and service phase

NISSAN dealers are our window to you, our customer. In order to meet your expectations they provide not only high quality services but are also environmentally responsible. NISSAN promotes activities to recycle the waste generated as a result of service centre activities.

Disposal phase

Recycle your end of life vehicle or its components. When your NISSAN reaches the end of its life, and is no longer suitable for daily use, it still has value.

You can help prevent waste affecting the environment by bringing your NISSAN to be recycled at our collection networks in your area. Our collection networks guarantee no cost for the treatment of your ELV. For further information on how and where to dispose of your ELV refer to your local NISSAN dealer or consult: www.nissan-europe.com.

PROTECT THE ENVIRONMENT WHEN DRIVING

Your driving behaviour has significant impact on fuel economy and the environment. Follow the tips below for better fuel-efficiency, better driving habits, and to be environmentally friendly by reducing emissions:

Defensive driving

Anticipating traffic conditions and acting accordingly reduces fuel consumption, helping to protect our natural environment. Take your foot off the accelerator while approaching traffic lights and avoid last minute braking when the light turns red.

Avoid speeding, harsh acceleration, and strong braking. The gain in time does not offset pollution of the environment. Try to maintain speed when driving uphill to reduce fuel consumption and pollution. Maintain speed or allow the vehicle to go slower where traffic allows.

Close windows when driving

Driving with a window open at 100 km/h (62 MPH) increases fuel consumption by up to 4%. Driving with the windows closed allows for better fuel economy.



Use the roof rack only when necessary

Only install the roof luggage system when you really need it, otherwise put it inside the vehicle or store it in your garage. Do not drive around with an empty roof rack, kayak holder, or ski rack, this will reduce your aerodynamic drag significantly.

Optimise the use of air conditioning

The air conditioning system has a positive effect on driving and vehicle safety through comfort cooling and dehumidifying, drivers are more alert and have better visibility when window demisting/defogging becomes necessary. However, use of the air conditioning system will increase fuel consumption substantially in an urban environment. Optimise the use of air conditioning by using the vents as much as possible.

Use the parking brake on slopes

Use the parking brake when holding your vehicle on a slope. Avoid using the clutch (manual transmission) or the accelerator (automatic transmission or continuously variable transmission) to hold your vehicle as this leads to unnecessary fuel consumption and wear.

Maintain a safe distance

Anticipate traffic conditions for a smoother drive and to assure comfort and safety during your trip. Drive and maintain a safe distance from other vehicles while in traffic. This will help reduce fuel consumption as you will not be constantly tapping your brakes.

Check your tyre pressure

Low tyre pressure increases fuel consumption as well as the use of non-recommended tyres. Correct tyre pressure will maximise the grip of your vehicle and optimise fuel consumption.

Have your car serviced regularly

Regular service allows you to run your vehicle in optimal condition and with the best fuel efficiency. Have your vehicle serviced by your NISSAN dealer or a qualified workshop to ensure that it is maintained to its original standard.

QUICK REFERENCE

- In case of emergency ... 6-2
(Flat tyre, engine will not start, overheating, towing)
- How to start the engine ... 5-2
- How to read the meters and gauges ... 2-2
- Maintenance and do-it-yourself ... 8-2
- Technical information ... 9-2

تلفن شبانه روزی: ۰۲۱-۸۸۸۶۲۰۸۵

FarmaSOS.com



امداد خودرو فارما

تلفن شبانه روزی: ۰۸۵-۸۸۸۶۲۰۲۱

FarmaSOS.com



SECURITY INFORMATION

As owner of this vehicle important codes have been supplied to you that may be required by your NISSAN dealer to duplicate keys or repair the radio.

Please fill in the allocated areas or attach sticker(s) if available. Remove this page and keep it in a safe place, **not in the vehicle**.

When selling your vehicle, we kindly request you to hand over this page to the buyer.

SECURITY INFORMATION

Radio security code
(where fitted)

--	--	--	--

Key number

--	--	--	--

Wheel lock key code
(where fitted)

--	--	--	--	--	--	--	--

Remove this page from the manual and keep it in a safe place, **not in the vehicle**.

When selling your vehicle, we kindly request you to hand over this page to the buyer.



امداد خودرو فارما

تلفن شبانه روزی: ۰۲۱-۸۸۶۲۰۸۵

FarmaSOS.com



امداد خودرو فارما

تلفن شبانه روزی: ۰۸۵-۸۸۸۶۲۰۲۱

FarmaSOS.com

